

2 Nm double ovoid 1.4 and 3.2 Watts 3.2 W Part number 82729002



- Gearbox 2 Nm nominal
- Class A EMC interference suppression (radiated)
- Compatible with 6 V, 9 V or 12 V battery power supply
- Optional class B interference suppression
- Optional 1, 5, 12 or 48 pulses/rev encoder

Part numbers

	Type	Type	Voltage	Output speed (rpm)	Ratios (i)
82729002	3.2 W	827290	12 V	18	192

Specifications

General characteristics

Motor	82720001
Gearbox	810330
Maximum permitted torque from gearmotor under continuous conditions for 1 million turns (Nm)	2
Axial load static (daN)	1
Radial load static (daN)	10
Max. output power (W)	3,2
Nominal output (W)	2,6
Gearbox case temperature rise (°C)	40
Weight (g)	220

Dimensions (mm)

827290

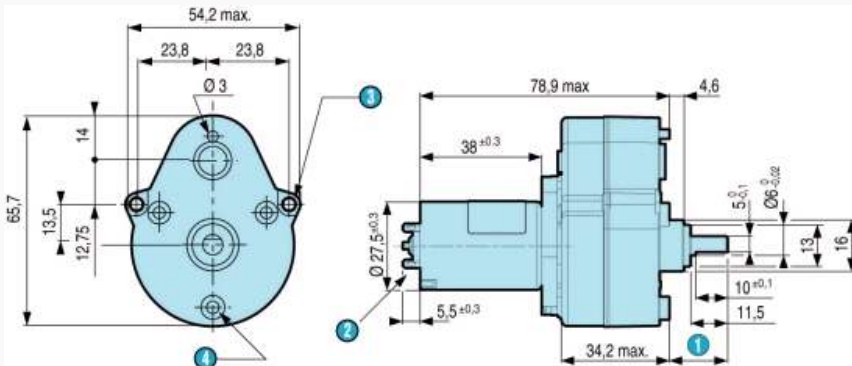

N°	Legend
①	18.2 mm max. shaft pushed-in
②	2 solder tags 2.8 x 0.5 mm
③	2 fixing holes Ø 3.2 mm
④	3 bosses Ø 7.2 at 120° on R=19.5 with M3 holes, depth : 4 mm

Dimensions (mm)

Shaft 79202573

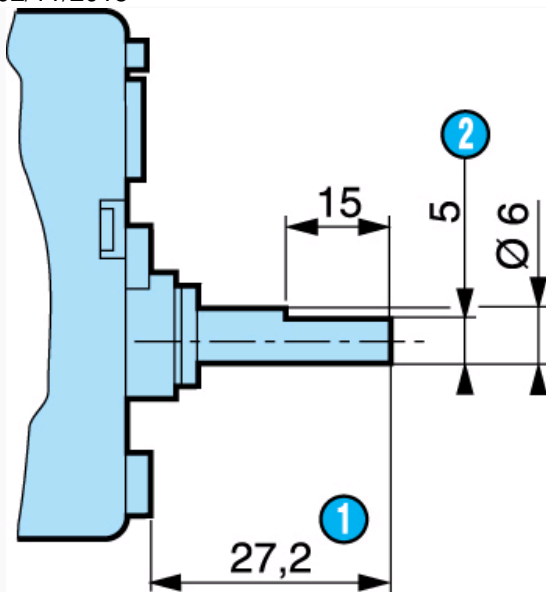

N°	Legend
1	Shaft pushed-in
2	5 across flats

Curves

Curve : torque/nominal speed 827290

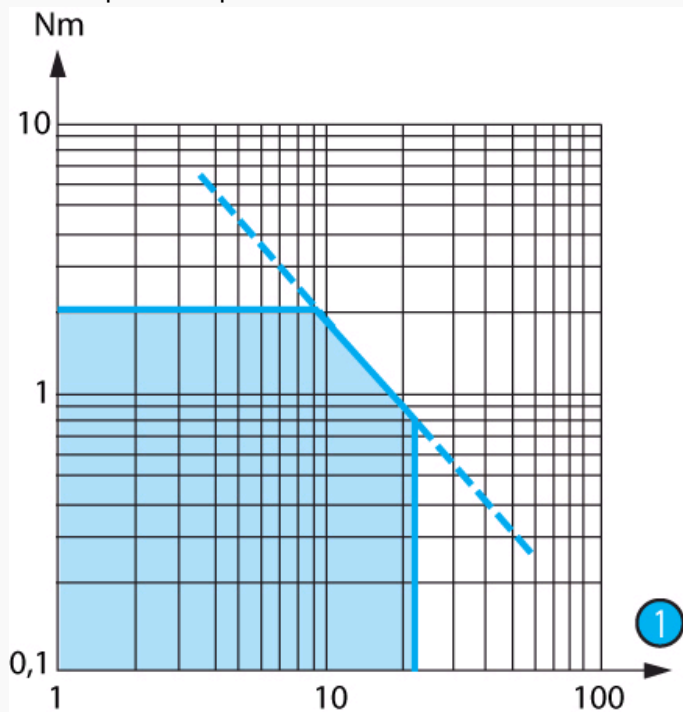

N°	Legend
1	rpm

Product adaptations



- Special supply voltage
- Lead output
- Special connectors
- Special shaft
- Special reduction ratio

- Special materials for gears
- Special ball bearings
- Special adaptor plate
- Class B EMC filter
- Friction
- Y system
- Greasing at low temperature
- 1 to 48 pulses/revolution encoder