

1

2

3

4

5

6

7

A

B

C

D

E

F

G

H

A

B

C

D

E

F

G

H

Material

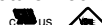
- Item 1 Clamp: Brass, Ni plated
 - Item 2 Terminal screw: Steel Zinc plating "-" slot type
 - Item 3 Wire guard solder pin: Brass, Tin plated
 - Item 4 Insulator (housing): Thermoplastic (UL94V-0), Blue
- Electrical UL / VDE
 Voltage rating: 300V/250V
 Current rating: 15A/10A
 Wire range: 0.34-4.0mm²
 Solid wire (AWG): 12-24
 Stranded wire (AWG): 12-24
 Torque (Lb-In): 3.5 Lb-In / 0.4 N.m
 Screw: M2.5
 Wire strip length: 6-7mm
 Withstanding Voltage: 1.6KV/2KV
 Operating temperature: -40°C to +115°C
 Soldering temperature: 250°C ± 10°C / 5 Sec
 Safety Approval: 

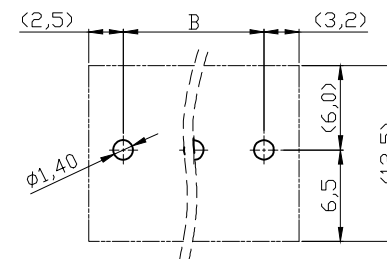
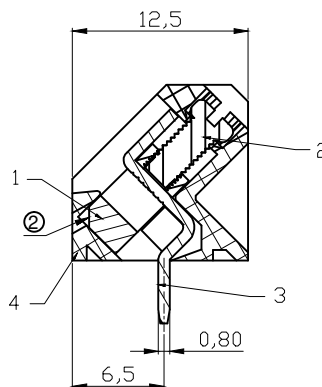
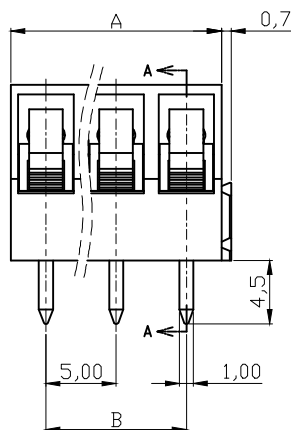
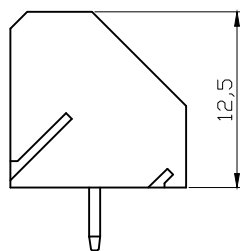
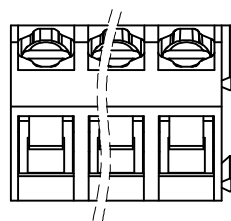

RECOMMENDED PCB LAYOUT

N=Number of poles
 A=Nx5.0
 B=(N-1)x5.0

POLES	A	B
2p-6p	±0.15	±0.15
7p-12p	±0.20	±0.20
13p-18p	±0.30	±0.30
19p-24p	±0.40	±0.40

RoHS compliant

Unit: mm



File No.: E349947

Scale	1:1					Date	Name	Customer-No.
TOLERANCE						Drawn	25.10.2007	Hellwig
X.	±0.50					Approved	18.04.2016	Joanna
X.X	±0.30							
X.XX	±0.10	③	Add UL	18.04.2016	Joanna			
DIM	TOL	②	Update	21.04.2010	Dean			
X.°	±1°	①	Drawn	25.10.2007	Hellwig			
Angle	TOL	Id.	Modification	Date	Name	Replace		Sheet

ASSMANN WSW-No.
A-TB500-TGxx

Drawing-No.
ASS 2375 CO rev03

1

2

3

4

5

6

7