

## 1. Product profile

### 1.1 General description

A 300 W LDMOS RF power transistor for broadcast transmitter applications and industrial applications. The transistor can deliver 300 W broadband over the full UHF band from 470 MHz to 860 MHz. The excellent ruggedness and broadband performance of this device makes it ideal for digital transmitter applications.

**Table 1. Typical performance**

*RF performance at  $V_{DS} = 42$  V in a common-source 860 MHz narrowband test circuit.*

Mode of operation	f (MHz)	$P_L$ (W)	$P_{L(PEP)}$ (W)	$P_{L(AV)}$ (W)	$G_p$ (dB)	$\eta_D$ (%)	IMD3 (dBc)
CW, class AB	860	300	-	-	21	60	-
2-Tone, class AB	$f_1 = 860; f_2 = 860.1$	-	300	-	21	46	-35
PAL BG	860 (ch69)	300 (peak sync.) <a href="#">[1]</a>	-	-	21	45	-
DVB-T (8k OFDM)	858	-	-	75	21	32	-32 <a href="#">[2]</a>

[1] Black video signal, sync expansion: input sync = 33 %; output sync  $\geq$  27 %.

[2] Measured [dBc] with delta marker at 4.3 MHz from center frequency.

### CAUTION



This device is sensitive to ElectroStatic Discharge (ESD). Therefore care should be taken during transport and handling.

### 1.2 Features

- 2-Tone performance at 860 MHz, a drain-source voltage  $V_{DS}$  of 42 V and a quiescent drain current  $I_{Dq} = 1.4$  A:
  - ◆ Peak envelope power load power = 300 W
  - ◆ Power gain = 21 dB
  - ◆ Drain efficiency = 46 %
  - ◆ Third order intermodulation distortion = -35 dBc
- DVB performance at 858 MHz, a drain-source voltage  $V_{DS}$  of 42 V and a quiescent drain current  $I_{Dq} = 1.4$  A:
  - ◆ Average output power = 75 W
  - ◆ Power gain = 21 dB
  - ◆ Drain efficiency = 32 %
  - ◆ Third order intermodulation distortion = -32 dBc (4.3 MHz from center frequency)

- Integrated ESD protection
- Advanced flange material for optimum thermal behavior and reliability
- Excellent ruggedness
- High power gain
- High efficiency
- Designed for broadband operation (470 MHz to 860 MHz)
- Excellent reliability
- Internal input and output matching for high gain and optimum broadband operation
- Easy power control
- Compliant to Directive 2002/95/EC, regarding Restriction of Hazardous Substances (RoHS)

### 1.3 Applications

- Communication transmitter applications in the UHF band
- Industrial applications in the UHF band

## 2. Pinning information

Table 2. Pinning

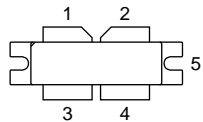
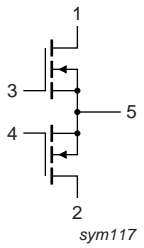
Pin	Description	Simplified outline	Graphic symbol
1	drain1		 <p style="text-align: right; margin-right: 50px;"><i>sym117</i></p>
2	drain2		
3	gate1		
4	gate2		
5	source <a href="#">[1]</a>		

[1] Connected to flange.

## 3. Ordering information

Table 3. Ordering information

Type number	Package		
	Name	Description	Version
BLF878	-	flanged LDMOST ceramic package; 2 mounting holes; 4 leads	SOT979A

## 4. Limiting values

**Table 4. Limiting values**

In accordance with the Absolute Maximum Rating System (IEC 60134).

Symbol	Parameter	Conditions	Min	Max	Unit
$V_{DS}$	drain-source voltage		-	89	V
$V_{GS}$	gate-source voltage		-0.5	+11	V
$T_{stg}$	storage temperature		-65	+150	°C
$T_j$	junction temperature		-	200	°C

## 5. Thermal characteristics

**Table 5. Thermal characteristics**

Symbol	Parameter	Conditions	Typ	Unit
$R_{th(j-c)}$	thermal resistance from junction to case	$T_{case} = 80\text{ °C}$ ; $P_{L(AV)} = 150\text{ W}$	[1]	0.23 K/W
$R_{th(c-h)}$	thermal resistance from case to heatsink		[2]	0.15 K/W

[1]  $R_{th(j-c)}$  is measured under RF conditions.

[2]  $R_{th(c-h)}$  is dependent on the applied thermal compound and clamping/mounting of the device.

## 6. Characteristics

**Table 6. Characteristics**

$T_j = 25\text{ °C}$  unless otherwise specified.

Symbol	Parameter	Conditions	Min	Typ	Max	Unit
$V_{(BR)DSS}$	drain-source breakdown voltage	$V_{GS} = 0\text{ V}$ ; $I_D = 2.25\text{ mA}$	[1]	89	-	105.5 V
$V_{GS(th)}$	gate-source threshold voltage	$V_{DS} = 10\text{ V}$ ; $I_D = 225\text{ mA}$	[1]	1.4	1.9	2.4 V
$I_{DSS}$	drain leakage current	$V_{GS} = 0\text{ V}$ ; $V_{DS} = 42\text{ V}$	-	-	1.4	μA
$I_{DSX}$	drain cut-off current	$V_{GS} = V_{GSth} + 3.75\text{ V}$ ; $V_{DS} = 10\text{ V}$	35	39	-	A
$I_{GSS}$	gate leakage current	$V_{GS} = 11\text{ V}$ ; $V_{DS} = 0\text{ V}$	-	-	140	nA
$g_{fs}$	forward transconductance	$V_{DS} = 10\text{ V}$ ; $I_D = 11.2\text{ A}$	[1]	-	15.5	S
$R_{DS(on)}$	drain-source on-state resistance	$V_{GS} = V_{GSth} + 3.75\text{ V}$ ; $I_D = 7.6\text{ A}$	[1]	-	110	mΩ
$C_{iss}$	input capacitance	$V_{GS} = 0\text{ V}$ ; $V_{DS} = 40\text{ V}$ ; $f = 1\text{ MHz}$	[2]	-	190	pF
$C_{oss}$	output capacitance	$V_{GS} = 0\text{ V}$ ; $V_{DS} = 40\text{ V}$ ; $f = 1\text{ MHz}$	[2]	-	60	pF
$C_{rss}$	reverse transfer capacitance	$V_{GS} = 0\text{ V}$ ; $V_{DS} = 40\text{ V}$ ; $f = 1\text{ MHz}$	[2]	-	2	pF

[1]  $I_D$  is the drain current.

[2] Capacitance values without internal matching.

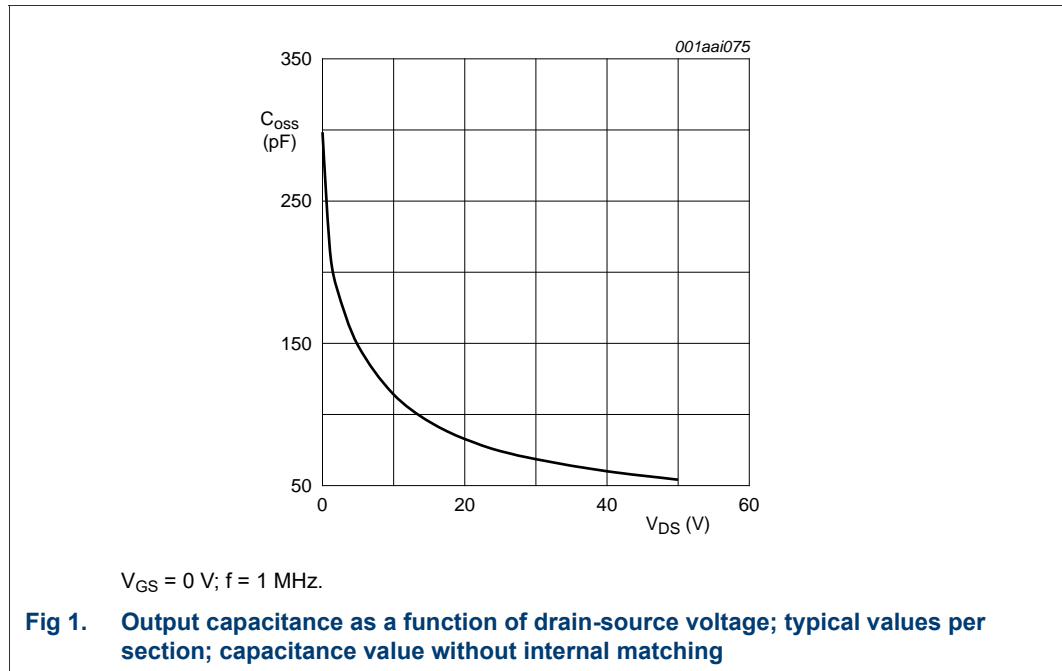

## 7. Application information

**Table 7. RF performance in a common-source narrowband 860 MHz test circuit**  
*T<sub>case</sub> = 25 °C unless otherwise specified.*

Mode of operation	f (MHz)	V <sub>DS</sub> (V)	I <sub>Dq</sub> (A)	P <sub>L(PEP)</sub> (W)	P <sub>L(AV)</sub> (W)	G <sub>p</sub> (dB)	η <sub>D</sub> (%)	IMD3 (dBc)
2-Tone, class AB	f <sub>1</sub> = 860; f <sub>2</sub> = 860.1	40	1.4 <sup>[1]</sup>	300	-	> 18	> 42	< -31
DVB-T (8k OFDM)	858	40	1.4 <sup>[1]</sup>	-	75	> 18	> 29	< -29 <sup>[2]</sup>

[1] I<sub>Dq</sub> = 1.4 A for total device.

[2] Measured [dBc] with delta marker at 4.3 MHz from center frequency.

7.1 Narrowband RF figures

7.1.1 CW

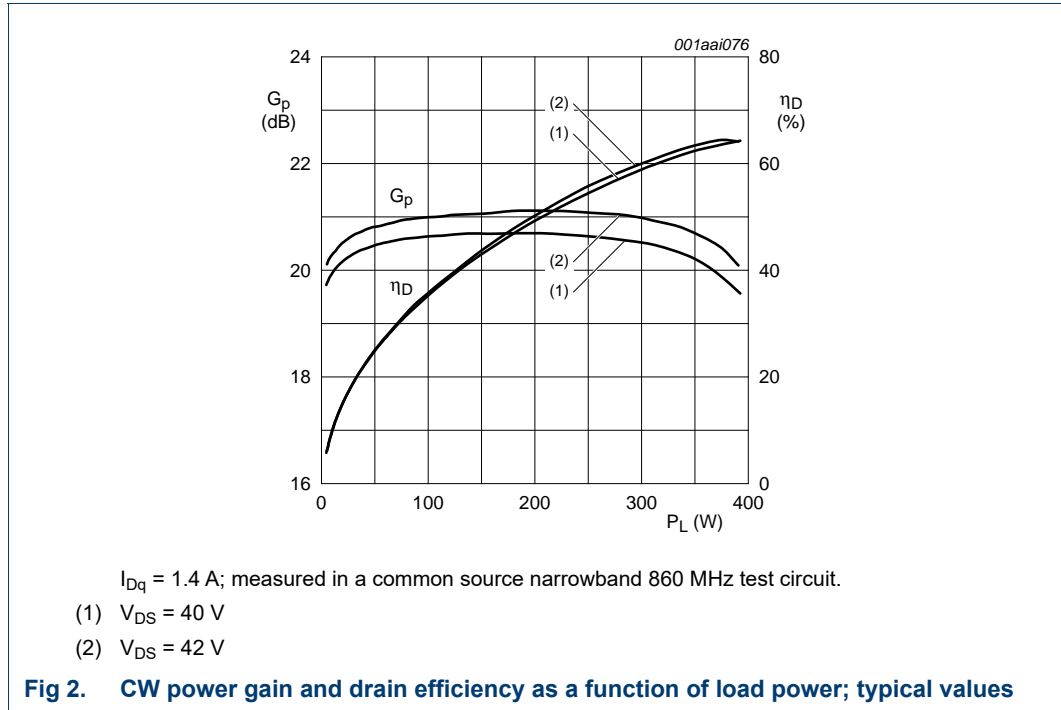

7.1.2 2-Tone

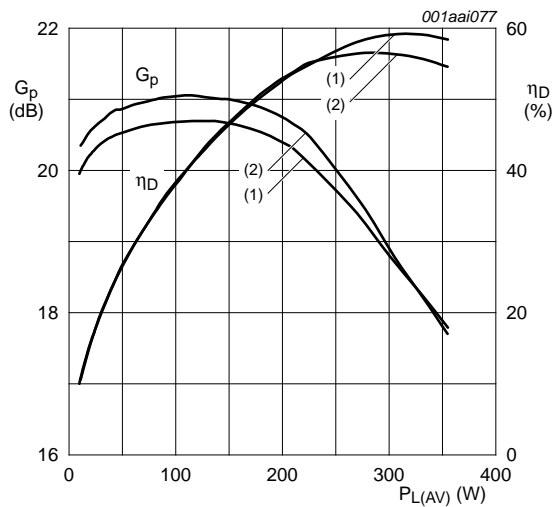

$I_{Dq} = 1.4$  A; measured in a common source narrowband 860 MHz test circuit.  
 (1)  $V_{DS} = 40$  V  
 (2)  $V_{DS} = 42$  V

**Fig 3. 2-Tone power gain and drain efficiency as functions of average load power; typical values**

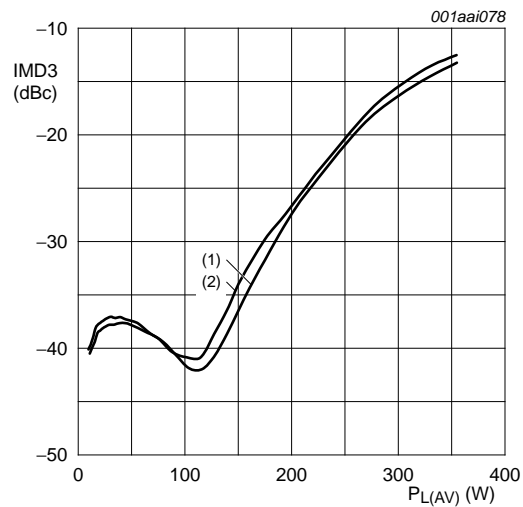

$I_{Dq} = 1.4$  A; measured in a common source narrowband 860 MHz test circuit.  
 (1)  $V_{DS} = 40$  V  
 (2)  $V_{DS} = 42$  V

**Fig 4. 2-Tone third order intermodulation distortion as a function of average load power; typical values**

7.1.3 DVB-T

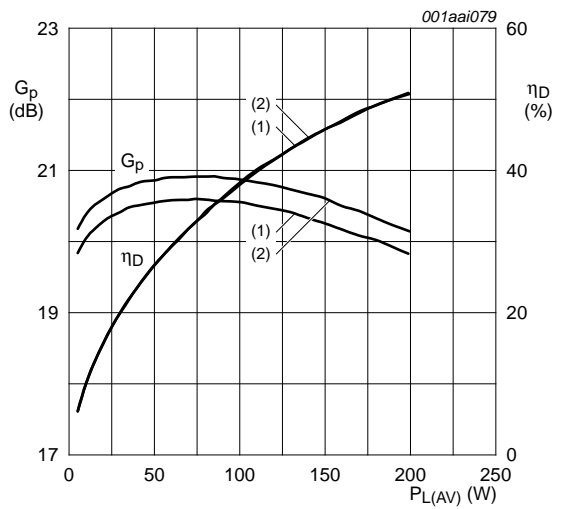

$I_{Dq} = 1.4$  A; measured in a common source narrowband 860 MHz test circuit.  
 (1)  $V_{DS} = 40$  V  
 (2)  $V_{DS} = 42$  V

**Fig 5. DVB-T power gain and drain efficiency as functions of average load power; typical values**

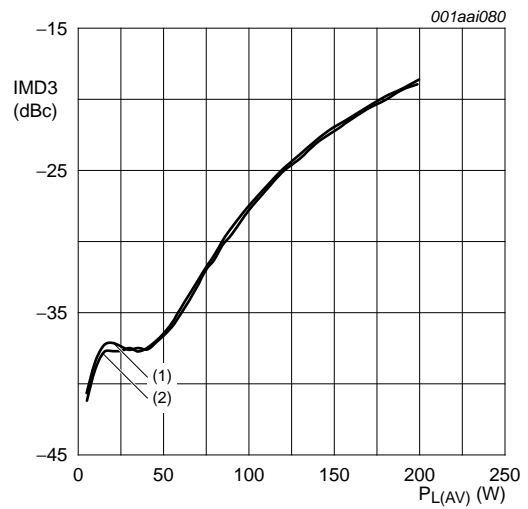

$I_{Dq} = 1.4$  A; measured in a common source narrowband 860 MHz test circuit.  
 (1)  $V_{DS} = 40$  V  
 (2)  $V_{DS} = 42$  V

**Fig 6. DVB-T third order intermodulation distortion as a function of average load power; typical values**

7.2 Broadband RF figures

7.2.1 2-Tone

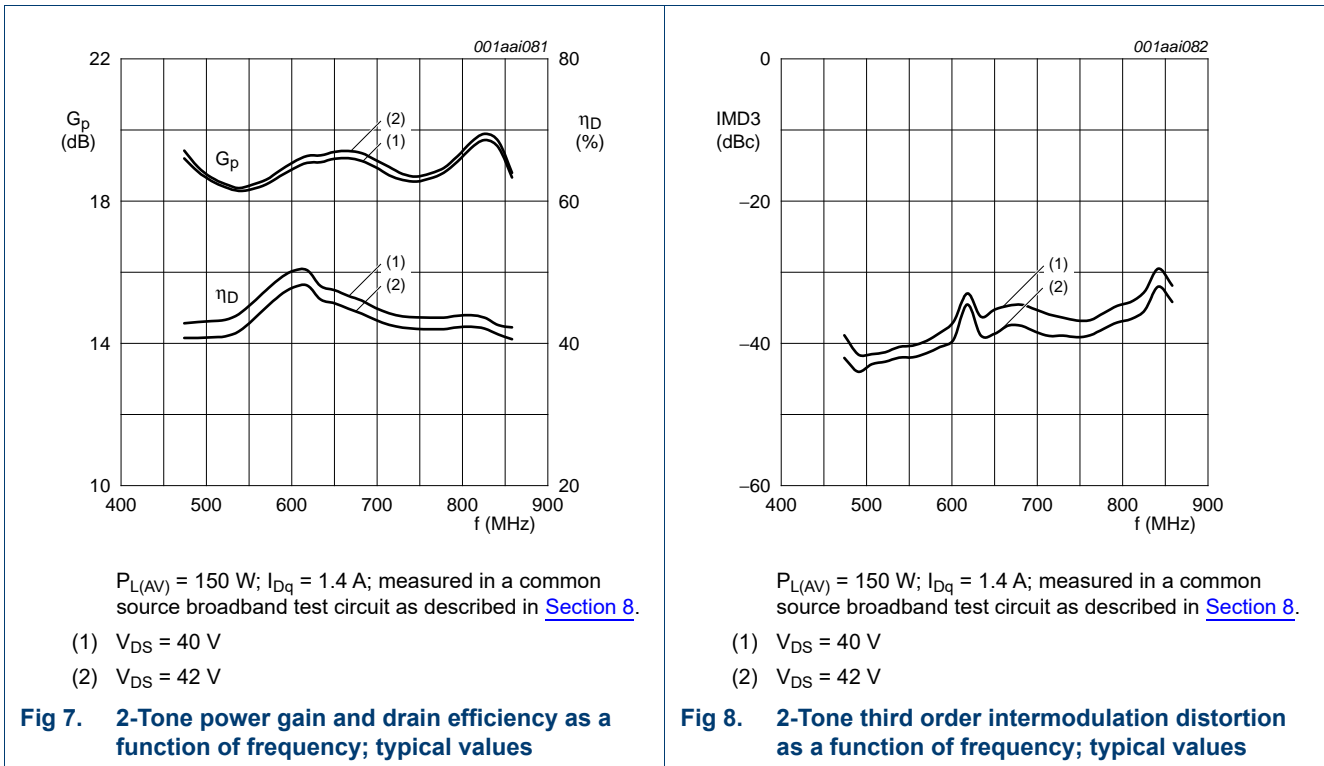



7.2.2 DVB-T

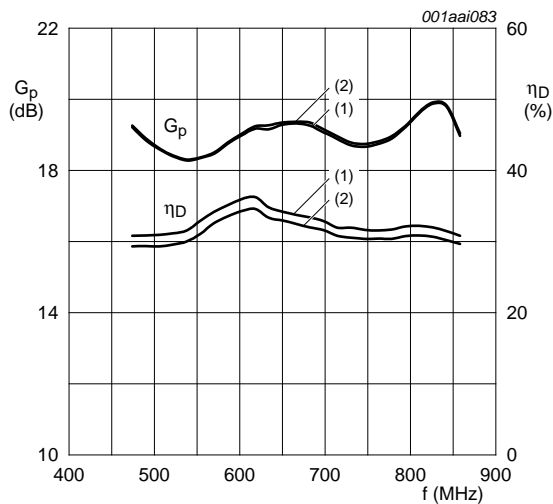

$P_{L(AV)} = 77 \text{ W}$ ;  $I_{Dq} = 1.4 \text{ A}$ ; measured in a common source broadband test circuit as described in [Section 8](#).  
 (1)  $V_{DS} = 40 \text{ V}$   
 (2)  $V_{DS} = 42 \text{ V}$

**Fig 9. DVB-T power gain and drain efficiency as functions of frequency; typical values**

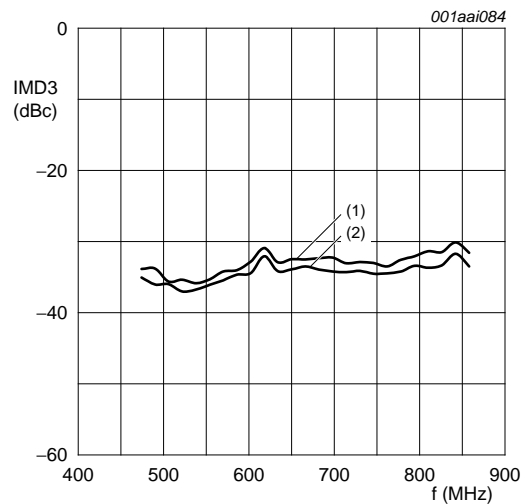

$P_{L(AV)} = 77 \text{ W}$ ;  $I_{Dq} = 1.4 \text{ A}$ ; measured in a common source broadband test circuit as described in [Section 8](#).  
 (1)  $V_{DS} = 40 \text{ V}$   
 (2)  $V_{DS} = 42 \text{ V}$

**Fig 10. DVB-T third order intermodulation distortion as a function of frequency; typical values**

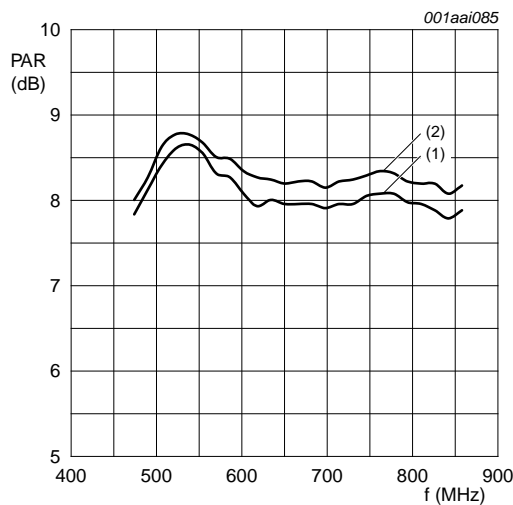

$P_{L(AV)} = 77 \text{ W}$ ;  $I_{Dq} = 1.4 \text{ A}$ ; measured in a common source broadband test circuit as described in [Section 8](#).  
 PAR of input signal = 9.5 dB at 0.01 % probability on CCDF.  
 (1)  $V_{DS} = 40 \text{ V}$   
 (2)  $V_{DS} = 42 \text{ V}$

**Fig 11. DVB-T PAR at 0.1 % and at 0.01 % probability on the CCDF as function of frequency; typical values**

### 7.3 Ruggedness in class-AB operation

The BLF878 is capable of withstanding a load mismatch corresponding to VSWR = 10 : 1 through all phases under the following conditions:  $V_{DS} = 42\text{ V}$ ;  $f = 860\text{ MHz}$  at rated power.

### 7.4 Impedance information

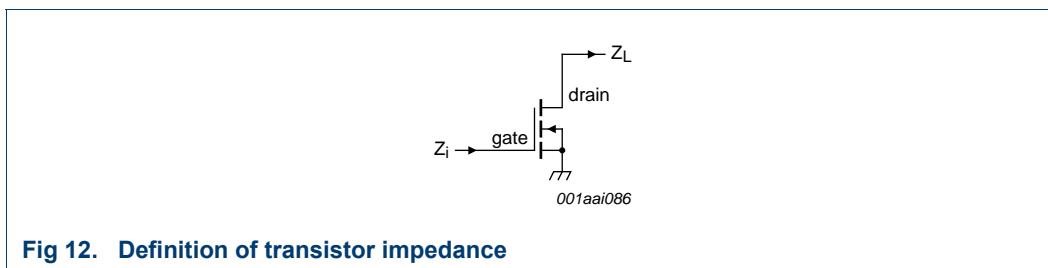

Fig 12. Definition of transistor impedance

Table 8. Typical push-pull impedance

Simulated  $Z_i$  and  $Z_L$  device impedance; impedance info at  $V_{DS} = 42\text{ V}$  and  $P_{L(PEP)} = 300\text{ W}$ .

f MHz	$Z_i$ $\Omega$	$Z_L$ $\Omega$
300	0.933 – j1.376	6.431 – j4.296
325	0.959 – j0.986	6.889 – j3.911
350	0.988 – j0.628	7.237 – j3.476
375	1.020 – j0.295	7.475 – j3.017
400	1.057 + j0.017	7.610 – j2.559
425	1.097 + j0.314	7.652 – j2.120
450	1.143 + j0.598	7.614 – j1.713
475	1.194 + j0.871	7.512 – j1.348
500	1.251 + j1.137	7.359 – j1.031
525	1.315 + j1.397	7.168 – j0.762
550	1.388 + j1.652	6.949 – j0.542
575	1.470 + j1.903	6.712 – j0.368
600	1.563 + j2.152	6.465 – j0.237
625	1.668 + j2.398	6.214 – j0.145
650	1.788 + j2.642	5.962 – j0.089
675	1.925 + j2.885	5.714 – j0.064
700	2.082 + j3.125	5.472 – j0.066
725	2.262 + j3.362	5.238 – j0.093
750	2.470 + j3.594	5.012 – j0.141
775	2.711 + j3.816	4.796 – j0.207
800	2.989 + j4.025	4.590 – j0.289
825	3.310 + j4.213	4.394 – j0.385
850	3.680 + j4.369	4.208 – j0.493
875	4.103 + j4.478	4.031 – j0.611
900	4.580 + j4.519	3.864 – j0.737

**Table 8. Typical push-pull impedance ...continued**

Simulated  $Z_i$  and  $Z_L$  device impedance; impedance info at  $V_{DS} = 42\text{ V}$  and  $P_{L(PEP)} = 300\text{ W}$ .

f MHz	$Z_i$ $\Omega$	$Z_L$ $\Omega$
925	5.103 + j4.467	3.706 - j0.871
950	5.656 + j4.291	3.556 - j1.011
975	6.205 + j3.963	3.415 - j1.157
1000	6.696 + j3.463	3.281 - j1.308

### 7.5 Reliability

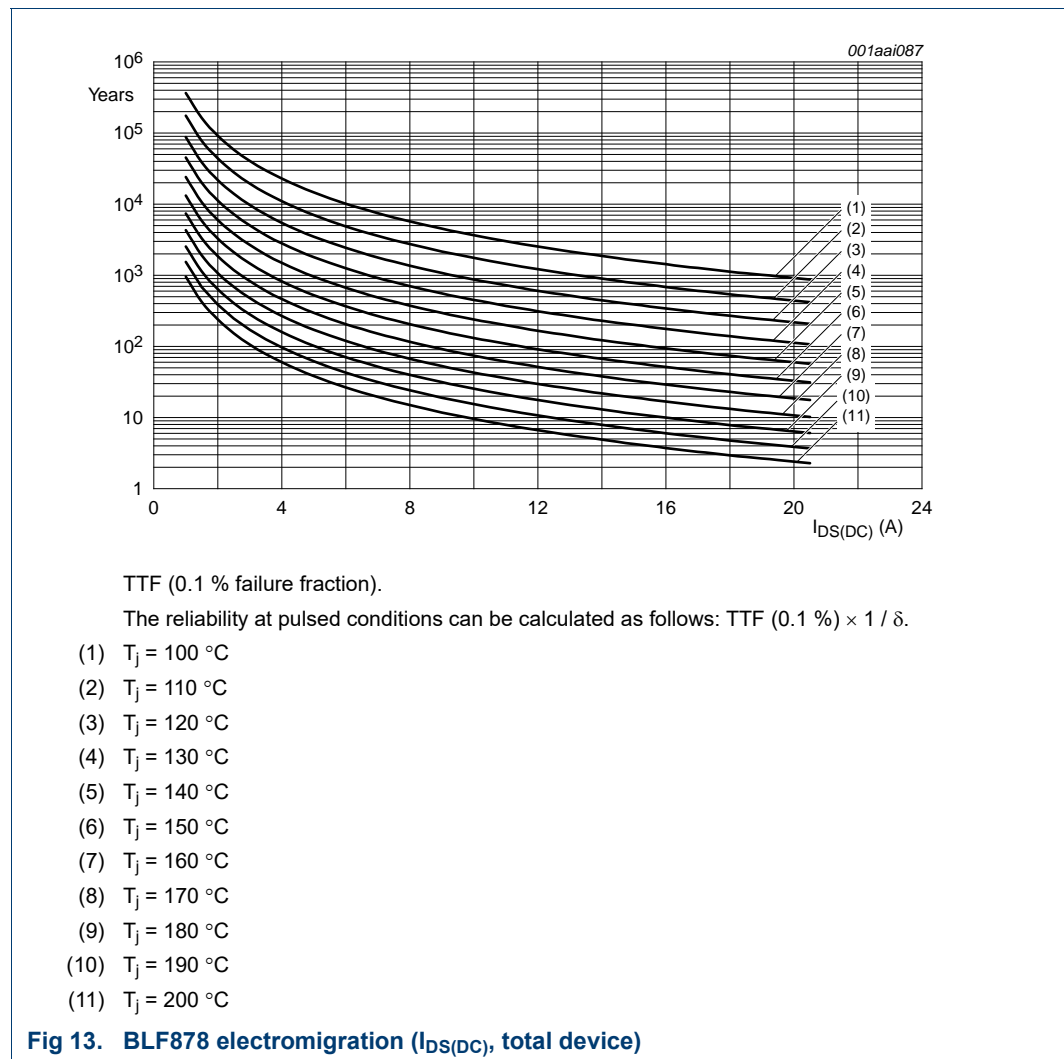

## 8. Test information

**Table 9. List of components**

For test circuit, see [Figure 14](#), [Figure 15](#) and [Figure 16](#).

Component	Description	Value	Remarks
B1, B2	semi rigid coax	25 Ω; 43.5 mm	EZ90-25-TP
C1, C2	multilayer ceramic chip capacitor	8.2 pF	[1]
C3, C9	multilayer ceramic chip capacitor	3.9 pF	[2]
C4	multilayer ceramic chip capacitor	2.7 pF	[2]
C5, C7, C8	multilayer ceramic chip capacitor	6.8 pF	[1]
C6	multilayer ceramic chip capacitor	2.2 pF	[2]
C10	multilayer ceramic chip capacitor	47 pF	[2]
C11, C12	multilayer ceramic chip capacitor	100 pF	[1]
C13, C14	multilayer ceramic chip capacitor	100 pF	[2]
C15, C16	multilayer ceramic chip capacitor	10 μF	TDK C570X7R1H106KT000N or capacitor of same quality.
C17, C18	electrolytic capacitor	470 μF; 63 V	
C20	multilayer ceramic chip capacitor	15 pF	[3]
C21	trimmer	0.6 pF to 4.5 pF	Tekelec
C22	multilayer ceramic chip capacitor	11 pF	[3]
C23	multilayer ceramic chip capacitor	3.9 pF	[3]
C24	multilayer ceramic chip capacitor	4.7 pF	[3]
C25, C26, C27	multilayer ceramic chip capacitor	100 pF	[3]
C28, C29	multilayer ceramic chip capacitor	560 pF	[2]
C30, C31	electrolytic capacitor	10 μF	
L1	stripline	-	[4] (W × L) 24 mm × 13 mm
L2	stripline	-	[4] (W × L) 15 mm × 24.5 mm
L3	stripline	-	[4] (W × L) 5 mm × 21 mm
L4	stripline	-	[4] (W × L) 2.4 mm × 6 mm
L5, L23	stripline	-	[4] (W × L) 2 mm × 43.5 mm
L6	stripline	-	[4] (W × L) 2 mm × 4.5 mm
L7	stripline	-	[4] (W × L) 5.5 mm × 24 mm
L20	stripline	-	[4] (W × L) 15 mm × 5 mm
L21	stripline	-	[4] (W × L) 3 mm × 39 mm
L22	stripline	-	[4] (W × L) 2.4 mm × 5.7 mm
R1, R2	resistor	5.6 Ω	long wires
R3, R4	potentiometer	10 kΩ	
R5, R6	resistor	10 kΩ	
R7, R8	resistor	1 kΩ	

[1] American technical ceramics type 180R or capacitor of same quality.

[2] American technical ceramics type 100B or capacitor of same quality.

[3] American technical ceramics type 100A or capacitor of same quality.

[4] Printed-Circuit Board (PCB): Rogers 5880;  $\epsilon_r = 2.2$  F/m; height = 0.79 mm; Cu (top/bottom metallization); thickness copper plating = 35 μm.

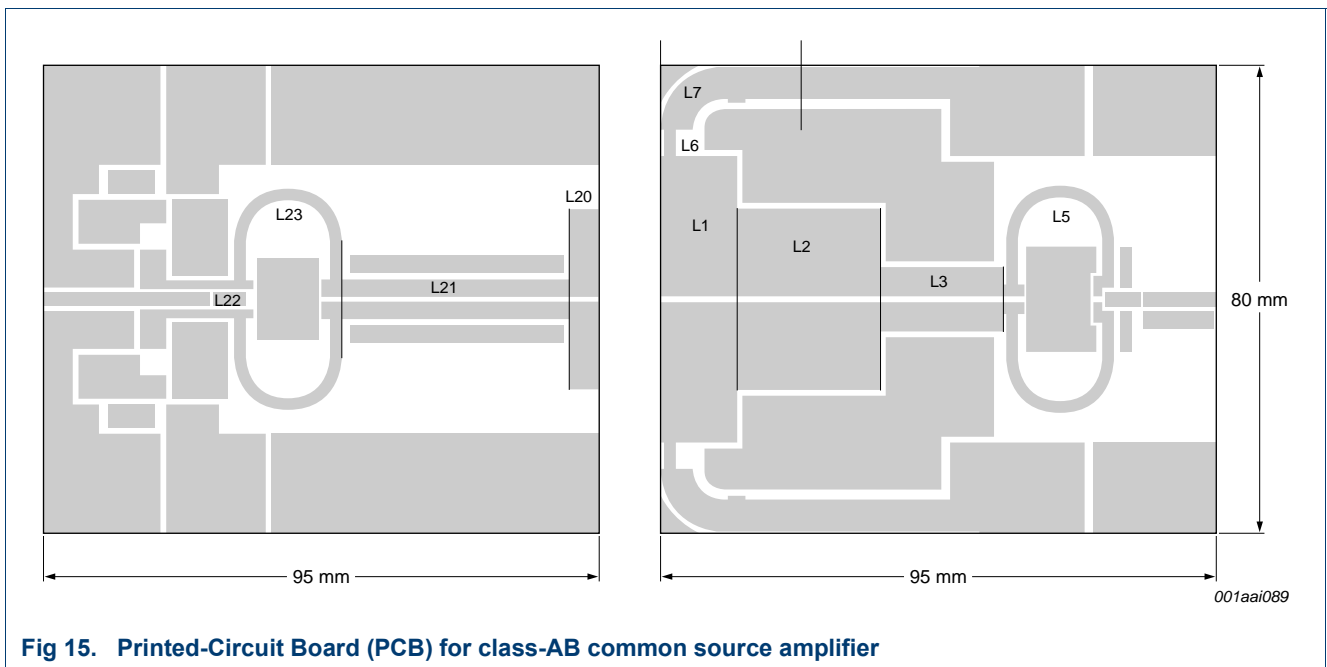
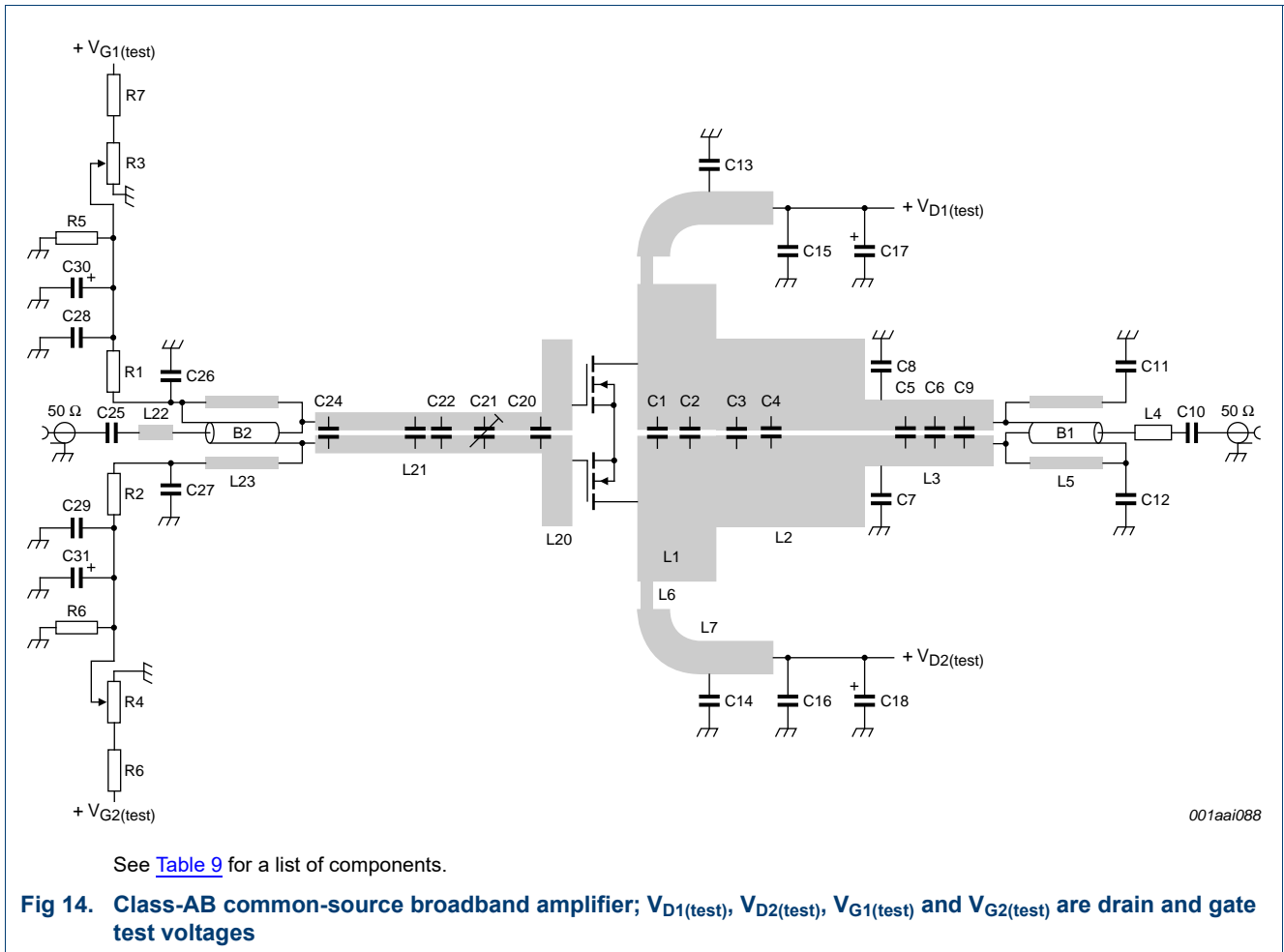

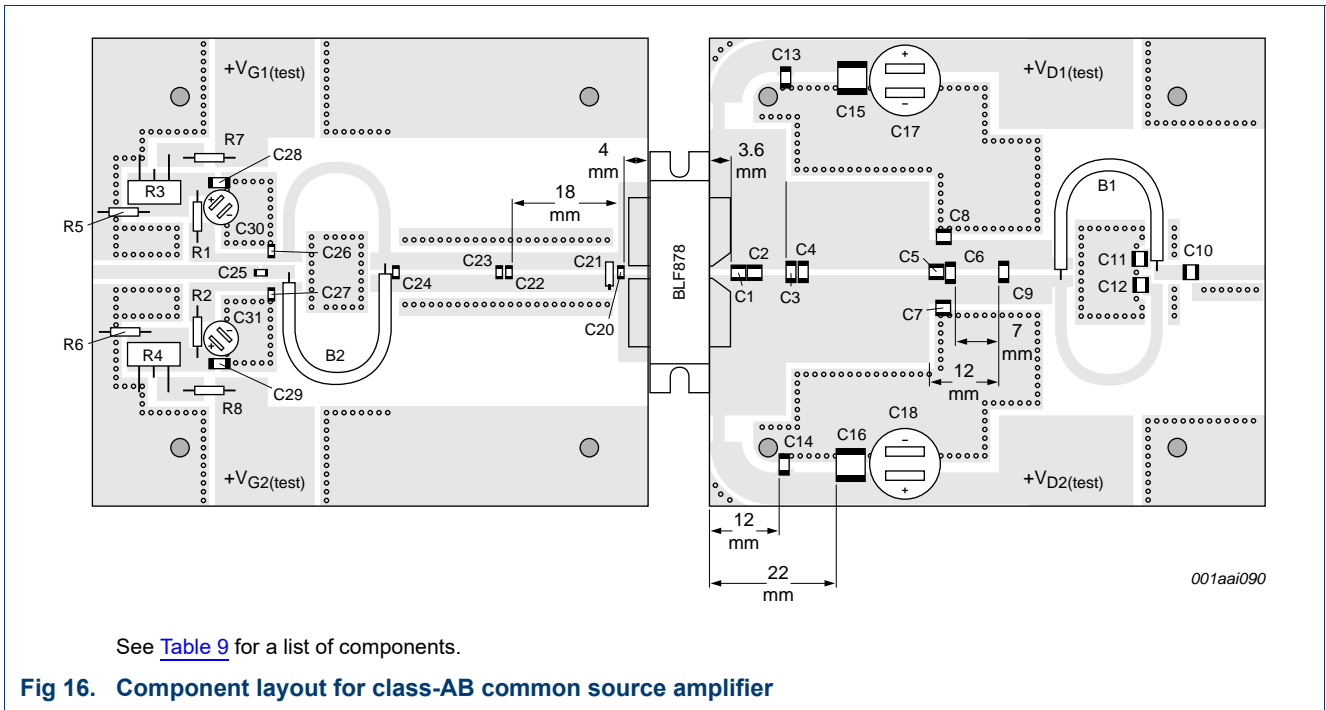

9. Package outline

Flanged LDMOST ceramic package; 2 mounting holes; 4 leads

SOT979A

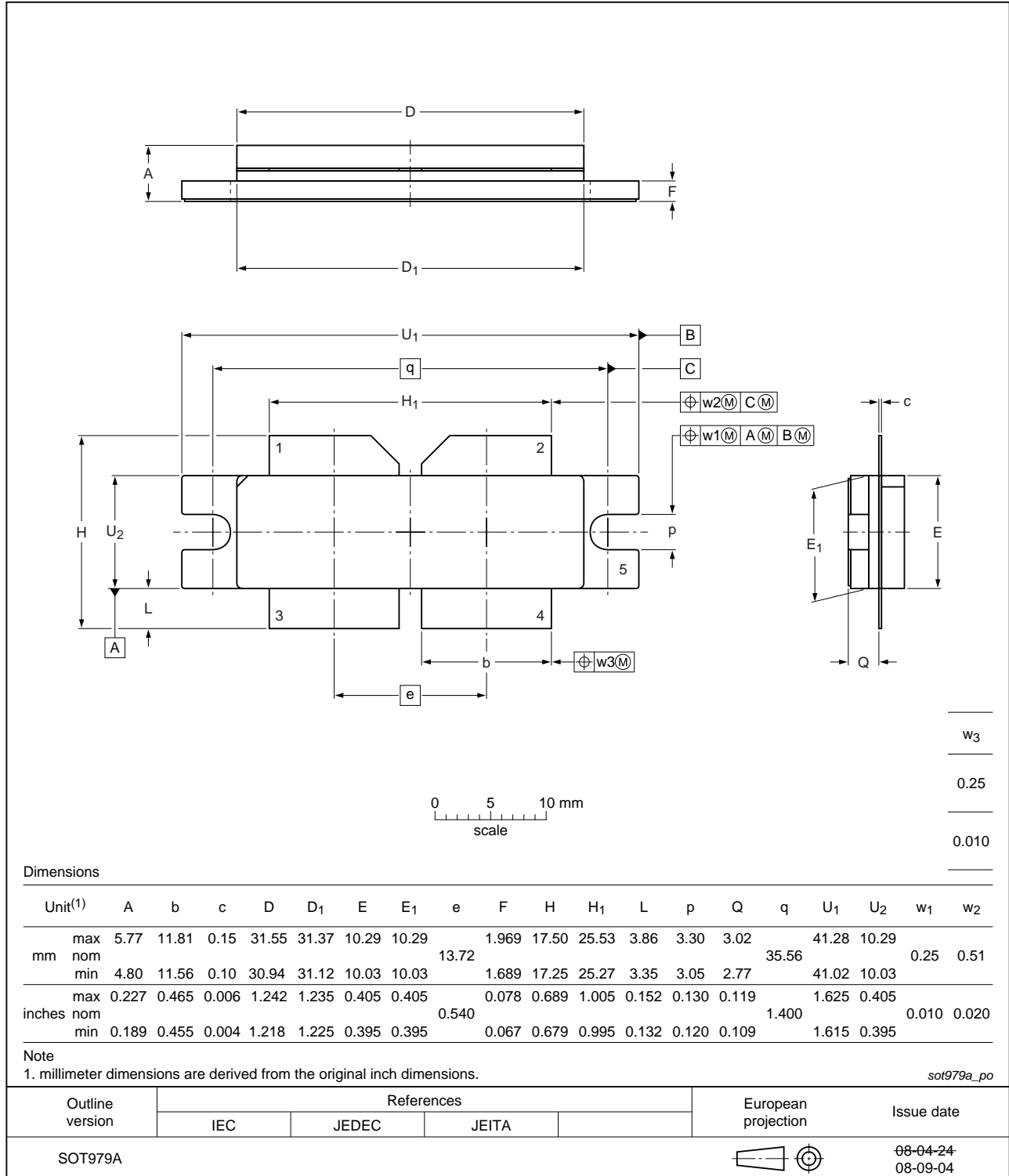

Fig 17. Package outline SOT979A

## 10. Abbreviations

Table 10. Abbreviations

Acronym	Description
CW	Continuous Wave
CCDF	Complementary Cumulative Distribution Function
DVB	Digital Video Broadcast
DVB-T	Digital Video Broadcast - Terrestrial
ESD	ElectroStatic Discharge
IMD3	Third order InterModulation Distortion
LDMOS	Laterally Diffused Metal-Oxide Semiconductor
LDMOST	Laterally Diffused Metal-Oxide Semiconductor Transistor
OFDM	Orthogonal Frequency Division Multiplexing
PAL	Phase Alternating Line
PAR	Peak-to-Average power Ratio
PEP	Peak Envelope Power
RF	Radio Frequency
TTF	Time To Failure
UHF	Ultra High Frequency
VSWR	Voltage Standing-Wave Ratio

## 11. Revision history

Table 11. Revision history

Document ID	Release date	Data sheet status	Change notice	Supersedes
BLF878#3	20150901	Product data sheet	-	BLF878_2
Modifications:	<ul style="list-style-type: none"> <li>The format of this document has been redesigned to comply with the new identity guidelines of Ampleon.</li> <li>Legal texts have been adapted to the new company name where appropriate.</li> </ul>			
BLF878_2	20090615	Product data sheet	-	BLF878_1
BLF878_1	20081215	Preliminary data sheet	-	-



## 12. Legal information

### 12.1 Data sheet status

Document status <sup>[1][2]</sup>	Product status <sup>[3]</sup>	Definition
Objective [short] data sheet	Development	This document contains data from the objective specification for product development.
Preliminary [short] data sheet	Qualification	This document contains data from the preliminary specification.
Product [short] data sheet	Production	This document contains the product specification.

[1] Please consult the most recently issued document before initiating or completing a design.

[2] The term 'short data sheet' is explained in section "Definitions".

[3] The product status of device(s) described in this document may have changed since this document was published and may differ in case of multiple devices. The latest product status information is available on the Internet at URL <http://www.ampleon.com>.

### 12.2 Definitions

**Draft** — The document is a draft version only. The content is still under internal review and subject to formal approval, which may result in modifications or additions. Ampleon does not give any representations or warranties as to the accuracy or completeness of information included herein and shall have no liability for the consequences of use of such information.

**Short data sheet** — A short data sheet is an extract from a full data sheet with the same product type number(s) and title. A short data sheet is intended for quick reference only and should not be relied upon to contain detailed and full information. For detailed and full information see the relevant full data sheet, which is available on request via the local Ampleon sales office. In case of any inconsistency or conflict with the short data sheet, the full data sheet shall prevail.

### 12.3 Disclaimers

**Limited warranty and liability** — Information in this document is believed to be accurate and reliable. However, Ampleon does not give any representations or warranties, expressed or implied, as to the accuracy or completeness of such information and shall have no liability for the consequences of use of such information. Ampleon takes no responsibility for the content in this document if provided by an information source outside of Ampleon.

In no event shall Ampleon be liable for any indirect, incidental, punitive, special or consequential damages (including - without limitation - lost profits, lost savings, business interruption, costs related to the removal or replacement of any products or rework charges) whether or not such damages are based on tort (including negligence), warranty, breach of contract or any other legal theory.

Notwithstanding any damages that customer might incur for any reason whatsoever, Ampleon' aggregate and cumulative liability towards customer for the products described herein shall be limited in accordance with the *Terms and conditions of commercial sale* of Ampleon.

**Right to make changes** — Ampleon reserves the right to make changes to information published in this document, including without limitation specifications and product descriptions, at any time and without notice. This document supersedes and replaces all information supplied prior to the publication hereof.

**Suitability for use** — Ampleon products are not designed, authorized or warranted to be suitable for use in life support, life-critical or safety-critical systems or equipment, nor in applications where failure or malfunction of an Ampleon product can reasonably be expected to result in personal injury, death or severe property or environmental damage. Ampleon and its suppliers accept no liability for inclusion and/or use of Ampleon products in such equipment or applications and therefore such inclusion and/or use is at the customer's own risk.

**Applications** — Applications that are described herein for any of these products are for illustrative purposes only. Ampleon makes no representation or warranty that such applications will be suitable for the specified use without further testing or modification.

Customers are responsible for the design and operation of their applications and products using Ampleon products, and Ampleon accepts no liability for any assistance with applications or customer product design. It is customer's sole responsibility to determine whether the Ampleon product is suitable and fit for the customer's applications and products planned, as well as for the planned application and use of customer's third party customer(s). Customers should provide appropriate design and operating safeguards to minimize the risks associated with their applications and products.

Ampleon does not accept any liability related to any default, damage, costs or problem which is based on any weakness or default in the customer's applications or products, or the application or use by customer's third party customer(s). Customer is responsible for doing all necessary testing for the customer's applications and products using Ampleon products in order to avoid a default of the applications and the products or of the application or use by customer's third party customer(s). Ampleon does not accept any liability in this respect.

**Limiting values** — Stress above one or more limiting values (as defined in the Absolute Maximum Ratings System of IEC 60134) will cause permanent damage to the device. Limiting values are stress ratings only and (proper) operation of the device at these or any other conditions above those given in the Recommended operating conditions section (if present) or the Characteristics sections of this document is not warranted. Constant or repeated exposure to limiting values will permanently and irreversibly affect the quality and reliability of the device.

**Terms and conditions of commercial sale** — Ampleon products are sold subject to the general terms and conditions of commercial sale, as published at <http://www.ampleon.com/terms>, unless otherwise agreed in a valid written individual agreement. In case an individual agreement is concluded only the terms and conditions of the respective agreement shall apply. Ampleon hereby expressly objects to applying the customer's general terms and conditions with regard to the purchase of Ampleon products by customer.

**No offer to sell or license** — Nothing in this document may be interpreted or construed as an offer to sell products that is open for acceptance or the grant, conveyance or implication of any license under any copyrights, patents or other industrial or intellectual property rights.

**Export control** — This document as well as the item(s) described herein may be subject to export control regulations. Export might require a prior authorization from competent authorities.

### 12.4 Trademarks

Notice: All referenced brands, product names, service names and trademarks are the property of their respective owners.

Any reference or use of any 'NXP' trademark in this document or in or on the surface of Ampleon products does not result in any claim, liability or

entitlement vis-à-vis the owner of this trademark. Ampleon is no longer part of the NXP group of companies and any reference to or use of the 'NXP' trademarks will be replaced by reference to or use of Ampleon's own Any reference or use of any 'NXP' trademark in this document or in or on the surface of Ampleon products does not result in any claim, liability or entitlement vis-à-vis the owner of this trademark. Ampleon is no longer part of

the NXP group of companies and any reference to or use of the 'NXP' trademarks will be replaced by reference to or use of Ampleon's own trademarks.

## 13. Contact information

---

For more information, please visit:

<http://www.ampleon.com>

For sales office addresses, please visit:

<http://www.ampleon.com/sales>

14. Contents

1 **Product profile** . . . . . 1

1.1 General description . . . . . 1

1.2 Features . . . . . 1

1.3 Applications . . . . . 2

2 **Pinning information** . . . . . 2

3 **Ordering information** . . . . . 2

4 **Limiting values** . . . . . 3

5 **Thermal characteristics** . . . . . 3

6 **Characteristics** . . . . . 3

7 **Application information** . . . . . 4

7.1 Narrowband RF figures . . . . . 5

7.1.1 CW . . . . . 5

7.1.2 2-Tone . . . . . 6

7.1.3 DVB-T . . . . . 7

7.2 Broadband RF figures . . . . . 8

7.2.1 2-Tone . . . . . 8

7.2.2 DVB-T . . . . . 9

7.3 Ruggedness in class-AB operation . . . . . 10

7.4 Impedance information . . . . . 10

7.5 Reliability . . . . . 11

8 **Test information** . . . . . 12

9 **Package outline** . . . . . 15

10 **Abbreviations** . . . . . 16

11 **Revision history** . . . . . 16

12 **Legal information** . . . . . 17

12.1 Data sheet status . . . . . 17

12.2 Definitions . . . . . 17

12.3 Disclaimers . . . . . 17

12.4 Trademarks . . . . . 18

13 **Contact information** . . . . . 18

14 **Contents** . . . . . 19

Please be aware that important notices concerning this document and the product(s) described herein, have been included in section 'Legal information'.

© Ampleon The Netherlands B.V. 2015. All rights reserved.

For more information, please visit: <http://www.ampleon.com>  
 For sales office addresses, please visit: <http://www.ampleon.com/sales>

Date of release: 1 September 2015  
 Document identifier: BLF878#3