

Relais Statique Triphasé

Three Phase Solid State Relays

SVT864994

24 to 520 VAC - 50 ARMS

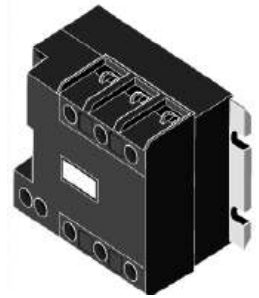

- Sortie AC Synchrones. / Pilotage de tout type de charge .
- Commande 90-240VAC/DC - LED
- IP20 - protection par réseau RC et VDR -
- Technologie thyristors
- Zero cross AC output . / Designed for all type of load.
- 90-240VAC/DC control voltage - LED
- IP20 - RC and VDR protection
- Thyristors technology

Dimensions / Dimensions:

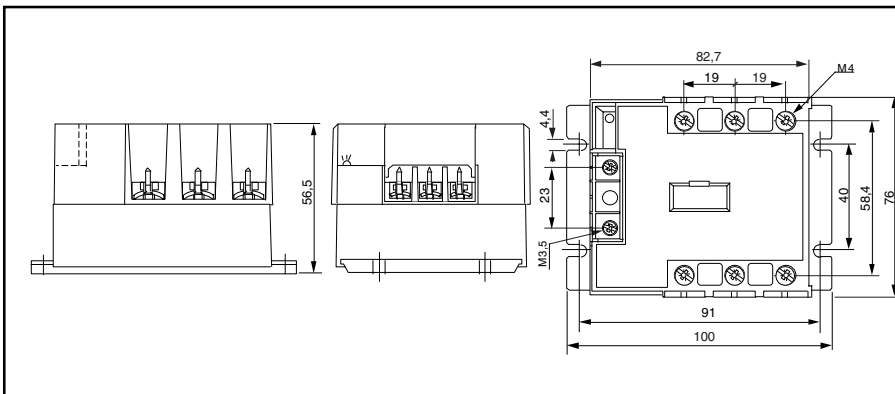

Circuit équivalent/Equivalent circuit :

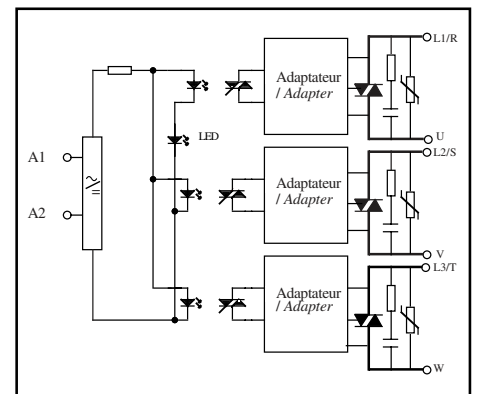

Caractéristiques de commande (à 20°C) / Control characteristics (at 20°C)

Paramètre / Parameter	Symbol	AC			Unit
		Min	Nom	Max	
Tension de commande / Control voltage	Uc	90		240	V
Courant de commande / Control current (@ Uc)	Ic	3		11	mA
Tension de relachement/Release voltage	Uc off	15			V
Résistance interne / Input internal resistor fig.1	Rc		21		KΩ
Tension inverse / Reverse voltage	Urv				V

Caractéristiques d'entrée-sortie (à 20°C) / Input-output characteristics (at 20°C)

Isolément entrée-sortie/Input-output isolation @500m	Ui		4000		VRMS
Isolément sortie-semelle/Output-case isolation @500m	Ui		2500		VRMS
Tension assignée isolement/ Rated impulse voltage	Uimp		4000		V

fig. 1 :Caractéristique d'entrée / Control characteristic

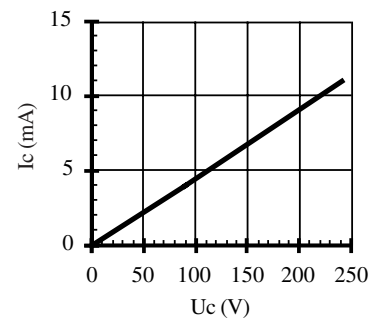

Caractéristiques générales / General characteristics

Paramètre / Parameter	Conditions	Symbol	Typ.	Unit
Poids/Weight			410	g
Plage de température de stockage / Storage temperature range			-40 / +100	°C
Plage de température de fonctionnement/Operating temperature range			-40 / +100	°C

Proud to serve you

All technical characteristics are subject to change without previous notice.
Caractéristiques sujettes à modifications sans préavis.

celduc®
r e l a i s

Caractéristiques de sortie (à 20°C) / Output characteristics (at 20°C)

Paramètre / Parameter	Conditions	Symbol	Typ.	Unit
Tension de charge / Load voltage		Ue	400	V rms
Plage tension de fonctionnement / Operating range	(480Vrms + 10%)	Uemax	530	V rms
Tension crête / Peak voltage		Up	1200	V
Niveau de synchronisation / Synchronizing level		Usync	12	V
Tension d'amorçage / Latching voltage	Ie nom	Ua	10	V
Courant nominal AC-51/ AC-51 nominal current	(see Fig. 2)	Ie AC-51	50	A rms
Courant nominal AC-53/ AC-53 nominal current	(see Fig. 2)	Ie AC-53	12	A rms
Courant de surcharge non répétitif / Non repetitive overload current	tp=10ms (Fig. 3)	I _{tsm}	550	A
Chute tension directe crête/ On state voltage drop	@ Ie nom	Vd	1,4	V
Courant de fuite état bloqué/ Off state leakage current	@Ue, 50Hz	I _{lk}	5	mA
Courant de charge minimum / Minimum load current		Ie min	5	mA
Temps de fermeture/ Turn on time	Uc nom DC ,f=50Hz	ton max	30	ms
Temps d'ouverture/ Turn off time	Uc nom DC ,f=50Hz	toff max	30	ms
Plage de fréquence / Operating frequency range		f	10-440	Hz
dv/dt état bloqué / Off state dv/dt		dv/dt	500	V/μs
dI/dt maximum non répétitif/ Maximum di/dt non repetitive		di/dt	50	A/μs
I ² t (<10ms)		I ² t	1500	A ² s
EMC Test d'immunité conduite / Conducted immunity level	IEC 1000-4-4 (burst)		2kV criterion A	
EMC Test d'immunité conduite / Conducted immunity level	IEC 1000-4-5(schocks)		2kV criterion A	
Conformité / Conformity	EN60947-4-x			

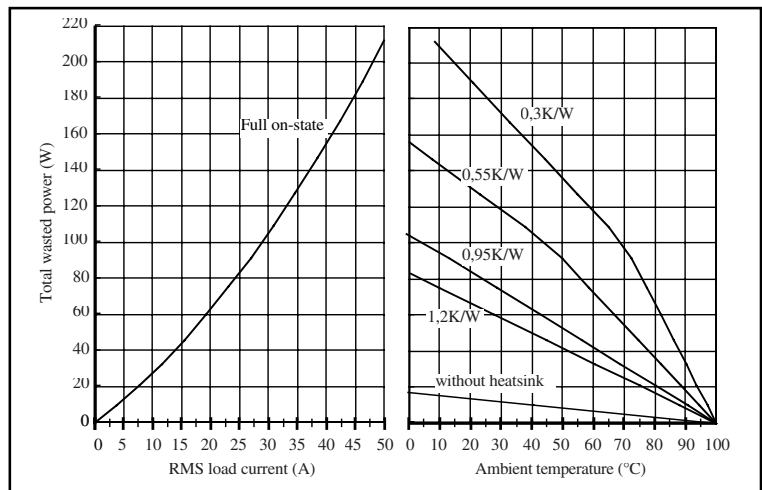
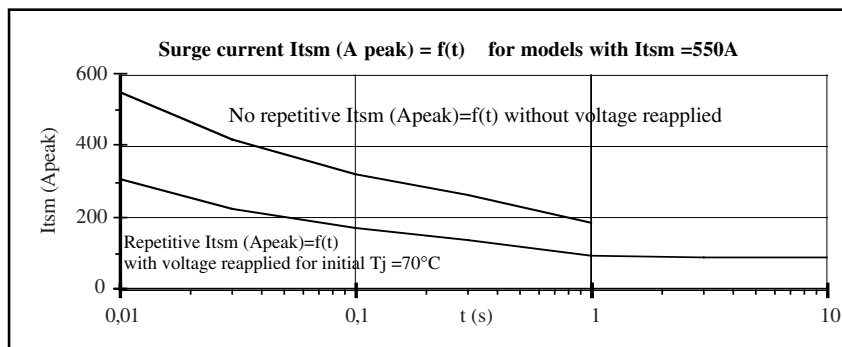
Caractéristiques thermiques /
thermal curves :Fig.3 Courbes de surcharge de courant /
Overload current curves

1 - Itsm non répétitif sans tension réappliquée est donné pour la détermination des protections.
No repetitive Itsm is given without voltage reapplied for the determination of the protection.

2 - Itsm répétitif est donné pour des surcharges de courant (Tj initiale=70°C). La répétition de ces surcharges de courant diminue la durée de vie du Relais.

Repetitive Itsm is given for inrush current with initial Tj = 70°C. The repetition of the surge current decrease the lifetime SSR's .

Précautions :

* Les relais à semiconducteurs ne procurent pas d'isolation galvanique entre le réseau et la charge.





Cautions :





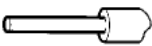

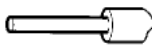
* Semiconductor relays don't provide any galvanic insulation between the load and the mains.

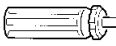
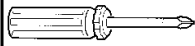
Proud to serve you

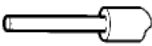
All technical characteristics are subject to change without previous notice.
Caractéristiques sujettes à modifications sans préavis.

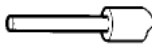
celduc[®]
r e l a i s

SVT Cablage commande / Wiring of the control circuit:						
nombre de fils/ NUMBER OF WIRES				SCREWDRIVER TYPE		MINIMUM TORQUE couple serrage
1		2		tournevis	tournevis	
SOLID (No ferrule) rigide sans embout	FINE STRANDED (With ferrule) multibrins avec embouts	SOLID (No ferrule) rigide sans embout	FINE STRANDED (With ferrule) multibrins avec embouts			N.m
						
0,75 ... 2,5 mm ²	0,75 ... 2,5 mm ²	0,75 ... 2,5 mm ²	0,75 ... 2,5 mm ²	0,8 x 5,5 mm	POZIDRIV 2	

SVT Cablage puissance / Wiring of the power circuit:						
NUMBER OF WIRES				SCREWDRIVER TYPE		MINIMUM TORQUE couple serrage
1		2		tournevis	tournevis	
SOLID (No ferrule) rigide sans embout	FINE STRANDED (With ferrule) multibrins avec embouts	SOLID (No ferrule) rigide sans embout	FINE STRANDED (With ferrule) multibrins avec embouts			N.m
						
1,5 ... 10 mm ²	1,5 ... 6 mm ²	1,5 ... 10 mm ²	1,5 ... 6 mm ²	0,8 x 5,5 mm	POZIDRIV 2	

