

NOTES:

1. MATERIAL:
HOUSING LCP, UL94V-0 AND GLOW WIRE CAPABLE PER IEC 60335-1, BLACK. TERMINAL COPPER
2. FINISH (PLATING):
(TIN) 1.52 MICROMETER MIN (60 MICROINCH MIN) REFLOWED MATTE TIN OVER
1.27 MICROMETER MIN (50 MICROINCH MIN) MIN NICKEL OVERALL.
(15 GOLD) 0.38 MICROMETER MIN (15 MICROINCH MIN) SELECTIVE GOLD ON CONTACT AREA
WITH 2.54 MICROMETER MIN (100 MICROINCHES MIN) SELECTIVE TIN ON SOLDER AREA
BOTH OVER 1.27 MICROMETER MIN (50 MICROINCHES MIN) NICKEL OVERALL.
(30 GOLD) 0.76 MICROMETER MIN (30 MICROINCH MIN) SELECTIVE GOLD ON CONTACT AREA
WITH 2.54 MICROMETER MIN (100 MICROINCHES MIN) SELECTIVE TIN ON SOLDER AREA
BOTH OVER 1.27 MICROMETER MIN (50 MICROINCHES MIN) NICKEL OVERALL.
3. PRODUCT SPECIFICATION 1720631000-PS.
4. PART MATES WITH MOLEX PART NUMBER 200456 SERIES.
5. PARTS CONFORM TO CLASS "B" REQUIREMENTS OF COSMETIC SPECIFICATION PS-45499-002.
6. PARTS TO BE PACKAGED PER 2002411000.
7. APPLICATION SPECIFICATION: 768232000-AS

SYMBOLS		THIS DRAWING CONTAINS INFORMATION THAT IS PROPRIETARY TO MOLEX ELECTRONIC TECHNOLOGIES, LLC AND SHOULD NOT BE USED WITHOUT WRITTEN PERMISSION	
DIMENSION UNITS	SCALE	CURRENT REV DESC:	
$\nabla = 0$	mm	2:1	<p>molex</p> <p>MEGA-FIT HDR ASMY TOP LATCH,VERT,2-8CKT</p>
$\nabla = 6$	GENERAL TOLERANCES (UNLESS SPECIFIED)		
$\nabla = 0$	ANGULAR TOL $\pm 0.5^\circ$		EC NO: 628261
$\nabla = 0$	4 PLACES	\pm	DRWN: ALUO02 2019/11/28
$\nabla = 0$	3 PLACES	\pm	CHK'D: AYIN 2019/12/11
$\nabla = 0$	2 PLACES	± 0.25	APPR: AYIN 2019/12/11
$\nabla = 0$	1 PLACE	± 0.35	INITIAL REVISION:
$\nabla = 0$	0 PLACES	\pm	DRWN: YXZHENG 2018/07/18
$\nabla = 0$	DRAFT WHERE APPLICABLE MUST REMAIN WITHIN DIMENSIONS		APPR: YXZHENG 2018/08/06
$\nabla = 0$	THIRD ANGLE PROJECTION		DOCUMENT NUMBER
DRAWING		SERIES	MATERIAL NUMBER
A3-SIZE		200241	2002411000
CUSTOMER		GENERAL MARKET	DOC TYPE
GENERAL MARKET		PSD	DOC PART
SHEET NUMBER		1 OF 3	REVISION
			C1

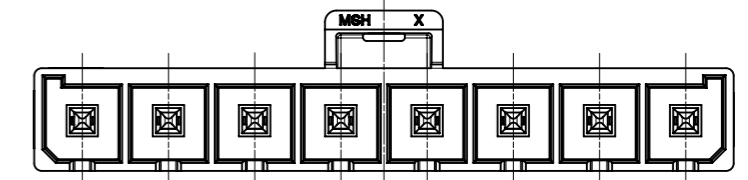
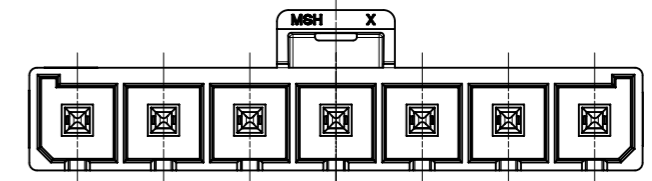
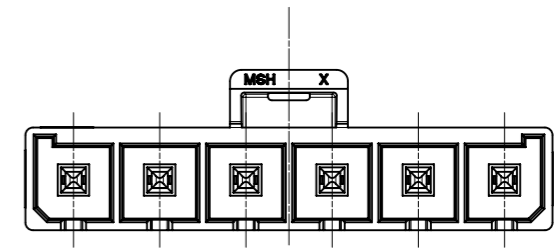
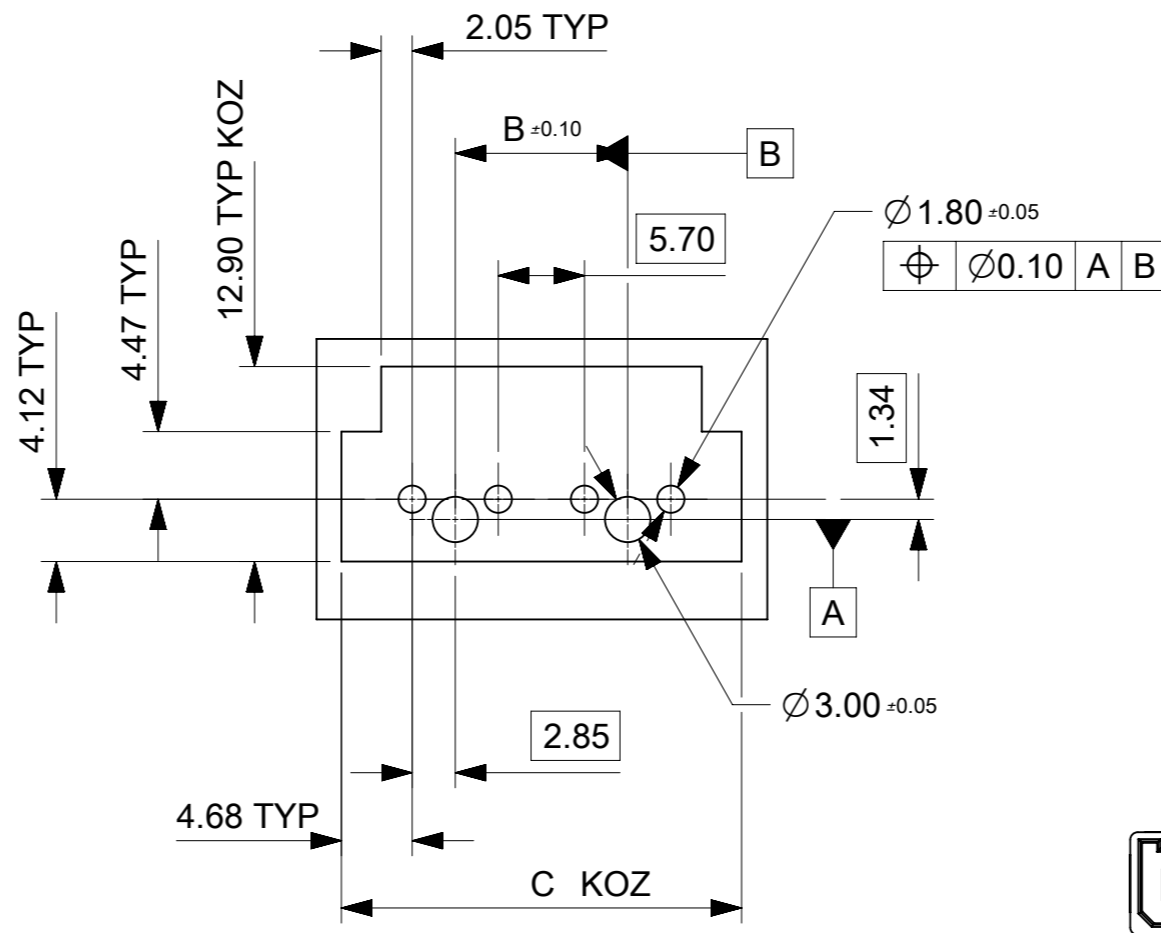
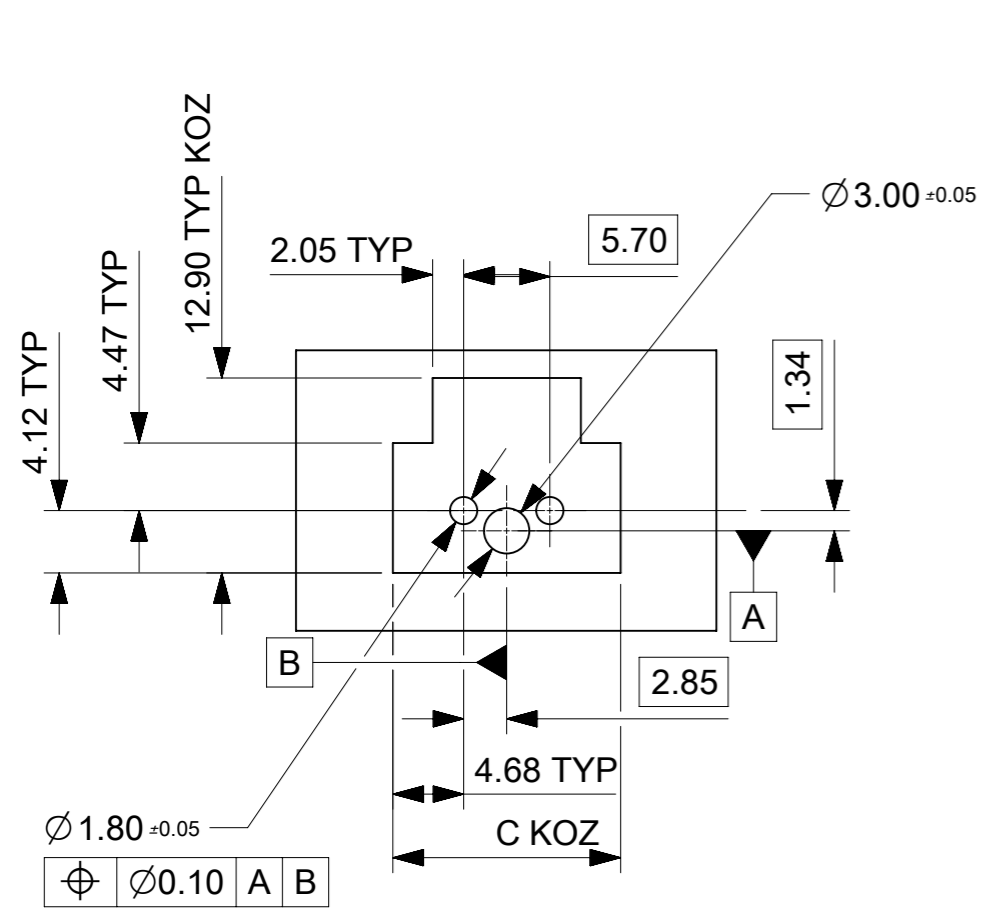
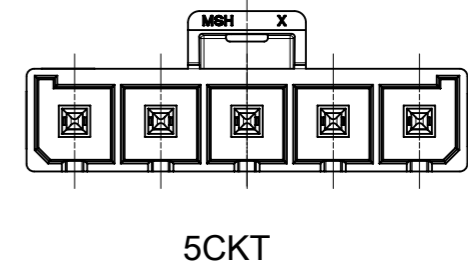
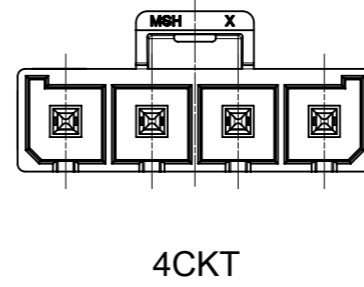
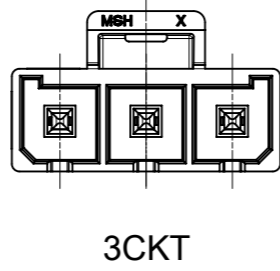
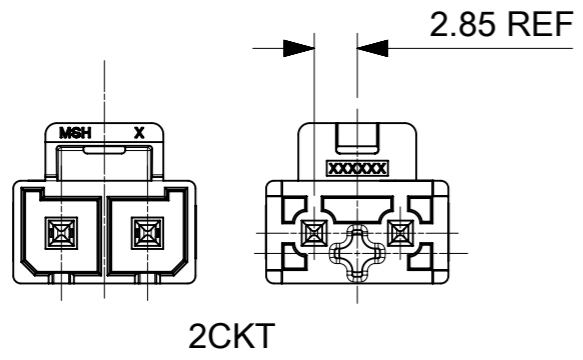

PCB LAYOUT: COMPONENT SIDE
RECOMMENDED PCB THICKNESS: 1.58 MM/.062 IN
TO2.36 MM/.093 IN

SYMBOLS	THIS DRAWING CONTAINS INFORMATION THAT IS PROPRIETARY TO MOLEX ELECTRONIC TECHNOLOGIES, LLC AND SHOULD NOT BE USED WITHOUT WRITTEN PERMISSION		CURRENT REV DESC:		molex
	▽ = 0	mm	SCALE	2:1	
▽ = 0	GENERAL TOLERANCES (UNLESS SPECIFIED)		EC NO: 628261		MEGA-FIT HDR ASMY TOP LATCH,VERT,2-8CKT
▽ = 0	ANGULAR TOL ± 0.5°		DRWN: ALUO02 2019/11/28		
▽ = 0	4 PLACES ±		CHK'D: AYIN 2019/12/11		PRODUCT CUSTOMER DRAWING
▽ = 0	3 PLACES ±		APPR: AYIN 2019/12/11		
▽ = 0	2 PLACES ± 0.25		INITIAL REVISION:		DOCUMENT NUMBER
▽ = 0	1 PLACE ± 0.35		DRWN: YXZHENG 2018/07/18		
▽ = 0	0 PLACES ±		APPR: YXZHENG 2018/08/06		2002411000
■ = 0	DRAFT WHERE APPLICABLE MUST REMAIN WITHIN DIMENSIONS		THIRD ANGLE PROJECTION	DRAWING	SERIES
▽ = 0				A3-SIZE	200241
			MATERIAL NUMBER	CUSTOMER	SHEET NUMBER
			SEE CHART	GENERAL MARKET	2 OF 3

9		8			7			6			5			4			3			2			1		
CKT	PLATING CODE	CORLOR	PART NUMBER	DIM-A	DIM-B	DIM-C	PK SPEC	CKT	PLATING CODE	CORLOR	PART NUMBER	DIM-A	DIM-B	DIM-C	PK SPEC	CKT	PLATING CODE	CORLOR	PART NUMBER	DIM-A	DIM-B	DIM-C	PK SPEC		
2	TIN	BLACK	2002411112	12.05	N/A	15.06	TRAY	*	2	TIN	BLACK	2002411712	12.05	N/A	15.06	*	2	TIN	BLACK	2002411612	12.05	N/A	15.06	TAPES&REEL WITH KAPTON	
3			2002411113	17.75	5.7	20.76		*	3			2002411713	17.75	5.7	20.76	*	3			2002411613	17.75	5.7	20.76		
4			2002411114	23.45	11.4	26.46		*	4			2002411714	23.45	11.4	26.46	*	4			2002411614	23.45	11.4	26.46		
5			2002411115	29.15	17.1	32.16		*	5			2002411715	29.15	17.1	32.16	*	5			2002411615	29.15	17.1	32.16		
6			2002411116	34.85	22.8	37.86		*	6			2002411716	34.85	22.8	37.86	*	6			2002411616	34.85	22.8	37.86		
7			2002411117	40.55	28.5	43.56		*	7			2002411717	40.55	28.5	43.56	*	7			2002411617	40.55	28.5	43.56		
8			2002411118	46.25	34.2	49.26		*	8			2002411718	46.25	34.2	49.26	*	8			2002411618	46.25	34.2	49.26		
2			15"GOLD	BLACK	2002411122	12.05		N/A	15.06			TRAY	*	2	15"GOLD	BLACK	2002411722			12.05	N/A	15.06	*		2
3	2002411123	17.75			5.7	20.76	*	3	2002411723	17.75	5.7		20.76	*			3	2002411623	17.75	5.7	20.76				
4	2002411124	23.45			11.4	26.46	*	4	2002411724	23.45	11.4		26.46	*			4	2002411624	23.45	11.4	26.46				
5	2002411125	29.15			17.1	32.16	*	5	2002411725	29.15	17.1		32.16	*			5	2002411625	29.15	17.1	32.16				
6	2002411126	34.85			22.8	37.86	*	6	2002411726	34.85	22.8		37.86	*			6	2002411626	34.85	22.8	37.86				
7	2002411127	40.55			28.5	43.56	*	7	2002411727	40.55	28.5		43.56	*			7	2002411627	40.55	28.5	43.56				
8	2002411128	46.25			34.2	49.26	*	8	2002411728	46.25	34.2		49.26	*			8	2002411628	46.25	34.2	49.26				
2	30"GOLD	BLACK			2002411132	12.05	N/A	15.06	TRAY	*	2		30"GOLD	BLACK			2002411732	12.05	N/A	15.06	*	2	30"GOLD	BLACK	2002411632
3			2002411133	17.75	5.7	20.76	*	3		2002411733	17.75	5.7			20.76	*	3	2002411633	17.75	5.7	20.76				
4			2002411134	23.45	11.4	26.46	*	4		2002411734	23.45	11.4			26.46	*	4	2002411634	23.45	11.4	26.46				
5			2002411135	29.15	17.1	32.16	*	5		2002411735	29.15	17.1			32.16	*	5	2002411635	29.15	17.1	32.16				
6			2002411136	34.85	22.8	37.86	*	6		2002411736	34.85	22.8			37.86	*	6	2002411636	34.85	22.8	37.86				
7			2002411137	40.55	28.5	43.56	*	7		2002411737	40.55	28.5			43.56	*	7	2002411637	40.55	28.5	43.56				
8			2002411138	46.25	34.2	49.26	*	8		2002411738	46.25	34.2			49.26	*	8	2002411638	46.25	34.2	49.26				

* DESIGNATES PART NOT RELEASED
CONTACT FACTORY FOR AVAILABILITY.

SYMBOLS = 0 = 0 = 0 = 0 = 0 = 0 = 0 = 0 = 0	THIS DRAWING CONTAINS INFORMATION THAT IS PROPRIETARY TO MOLEX ELECTRONIC TECHNOLOGIES, LLC AND SHOULD NOT BE USED WITHOUT WRITTEN PERMISSION DIMENSION UNITS: mm SCALE: 1:1	CURRENT REV DESC: EC NO: 628261 DRWN: ALUO02 2019/11/28 CHK'D: AYIN 2019/12/11 APPR: AYIN 2019/12/11 INITIAL REVISION: DRWN: YXZHENG 2018/07/18 APPR: YXZHENG 2018/08/06	molex		
	GENERAL TOLERANCES (UNLESS SPECIFIED) ANGULAR TOL ± 0.5° 4 PLACES ± 3 PLACES ± 2 PLACES ± 0.25 1 PLACE ± 0.35 0 PLACES ±		MEGA-FIT HDR ASMY TOP LATCH,VERT,2-8CKT		
	DRAFT WHERE APPLICABLE MUST REMAIN WITHIN DIMENSIONS		PRODUCT CUSTOMER DRAWING		
	THIRD ANGLE PROJECTION 		DRAWING: A3-SIZE SERIES: 200241	DOCUMENT NUMBER: 2002411000 DOC TYPE: PSD DOC PART: 000 REVISION: C1	MATERIAL NUMBER: 200241 CUSTOMER: GENERAL MARKET SHEET NUMBER: 3 OF 3