

Miniature, Low-cost, Single-pole PCB Relay

- Miniature: 15.5 x 10.5 x 11.5 mm (L x W x H).
- Low power consumption: 200 mW.
- Bifurcated crossbar contacts.
- Gold-clad contacts.
- Plastic-sealed type available.
- Ideal for telecommunications equipment and security systems.

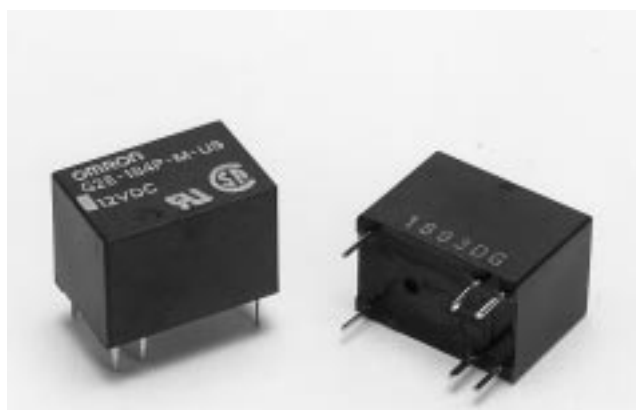

Ordering Information

Contact		General-purpose	High-sensitivity
		Plastic-sealed	Plastic-sealed
SPDT	Single crossbar	G2E-184P-M-US	G2E-184P-H-M-US
	Bifurcated crossbar	G2E-134P-M-US	G2E-134P-H-M-US

Note: When ordering, add the rated coil voltage to the model number.

Example: G2E-184P-M-US 12 VDC

Rated coil voltage

Model Number Legend:

G2E - - - - VDC
 1 2 3 4 5 6 7 8

1. Contact Form

1: SPDT

2. Contact Type

3: Bifurcated crossbar

8: Single crossbar

3. Enclosure Rating

4: Plastic-sealed

4. Terminals

P: Straight PCB

5. Power Consumption

None: General-purpose (450 mW)

H: High-sensitivity (200 mW)

6. Classification

M: General-purpose

7. Approved Standards

US: UL, CSA certified

8. Rated Coil Voltage

1.5, 3, 5, 6, 9, 12, 24 VDC

Specifications

■ Coil Ratings

General-purpose Relays

Rated voltage	1.5 VDC	3 VDC	5 VDC	6 VDC	9 VDC	12 VDC	24 VDC
Rated current	300 mA	150 mA	89.3 mA	75 mA	50 mA	37.5 mA	18.8 mA
Coil resistance	5 Ω	20 Ω	56 Ω	80 Ω	180 Ω	320 Ω	1,280 Ω
Coil inductance (H) (ref. value)	Armature OFF	0.005	0.017	0.044	0.067	0.137	0.229
	Armature ON	0.009	0.034	0.091	0.136	0.297	0.496
Must operate voltage	70% max. of rated voltage						
Must release voltage	10% min. of rated voltage						
Max. voltage	120% of rated voltage at 23°C, 110% at °60C						
Power consumption	Approx. 450 mW						

High-sensitivity Relays

Rated voltage	1.5 VDC	3 VDC	5 VDC	6 VDC	9 VDC	12 VDC	24 VDC
Rated current	125 mA	66.7 mA	41.7 mA	33.3 mA	22.5 mA	17.1 mA	8.6 mA
Coil resistance	12 Ω	45 Ω	120 Ω	180 Ω	400 Ω	700 Ω	2,800 Ω
Coil inductance (H) (ref. value)	Armature OFF	0.005	0.022	0.055	0.083	0.165	0.228
	Armature ON	0.009	0.035	0.092	0.129	0.303	0.504
Must operate voltage	80% max. of rated voltage						
Must release voltage	10% min. of rated voltage						
Max. voltage	140% of rated voltage at 23°C, 130% at 65°C						
Power consumption	Approx. 200 mW						

- Note:** 1. The rated current and coil resistance are measured at a coil temperature of 23°C with a tolerance of ±10%.
2. Operating characteristics are measured at a coil temperature of 23°C.

■ Contact Ratings

Item	Single crossbar	Bifurcated crossbar
Load	Resistive load ($\cos\phi = 1$)	Resistive load ($\cos\phi = 1$)
Rated load	0.5 A at 110 VAC; 1 A at 24 VDC	0.5 A at 110 VAC; 1 A at 24 VDC
Contact material	AgPd (Au-clad)	
Rated carry current	2 A	
Max. switching voltage	125 VAC, 60 VDC	
Max. switching current	1 A	
Max. switching capacity	120 VA, 30 W	120 VA, 30 W
Min. permissible load	1 mA at 5 VDC	0.1 mA at 0.1 VDC

Note: P level: $\lambda_{60} = 0.1 \times 10^{-6}/\text{operation}$

■ Characteristics

Contact resistance	50 mΩ max.
Operate time	General-purpose type: 5 ms max. (mean value: approx. 2.5 ms) High-sensitivity type: 7 ms max. (mean value: approx. 3.5 ms)
Release time	3 ms max. (mean value: approx. 0.8 ms)
Max. operating frequency	Mechanical: 18,000 operations/hr Electrical: 1,800 operations/hr (under rated load)
Insulation resistance	100 MΩ min. (at 500 VDC)
Dielectric withstand voltage	500 VAC, 50/60 Hz for 1 min between coil and contacts 500 VAC, 50/60 Hz for 1 min between contacts of same polarity
Vibration resistance	Destruction: 10 to 55 Hz, 3.3-mm double amplitude Malfunction: 10 to 55 Hz, 3.3-mm double amplitude
Shock resistance	Destruction: 1,000 m/s ² (approx. 100G) Malfunction: 200 m/s ² (approx. 20G)
Life expectancy	Mechanical: 10,000,000 operations min. (at 18,000 operations/hr) Electrical: DC: 500,000 operations min. (1 A at 24 VDC resistive load) AC: 200,000 operations min. (0.5 A at 110 VAC resistive load) (at 1,800 operations/hr)
Ambient temperature	Operating: -25°C to 60°C (with no icing) (high-sensitivity type: -25°C to 65°C)
Ambient humidity	Operating: 35% to 85%
Weight	Approx. 3.7 g

■ Approved Standards

UL114, UL478, UL1950 (File No. E41515)/CSA C22.2 No.0, No.14 (File No. LR34815-97)

Model	Contact form	Coil ratings	Contact ratings
G2E-184P-M-US G2E-184P-H-M-US G2E-134P-M-US G2E-134P-H-M-US	SPDT	1.5 to 24 VDC	0.5 A, 125 VAC (general use) 1 A, 28 VDC (resistive)

Engineering Data

Max. Switching Capacity

G2E-184P-M-US

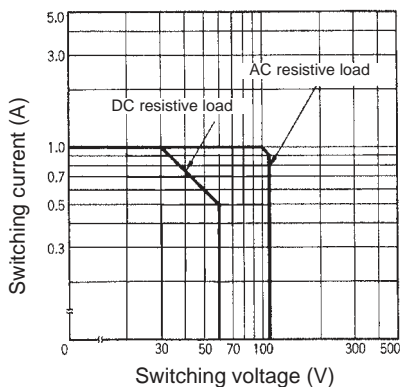

Life Expectancy

G2E-184P-M-US

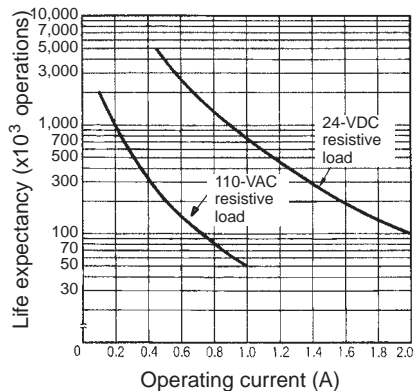

Dimensions

Note: 1. All units are in millimeters unless otherwise indicated.

2. Orientation marks are indicated as follows:  

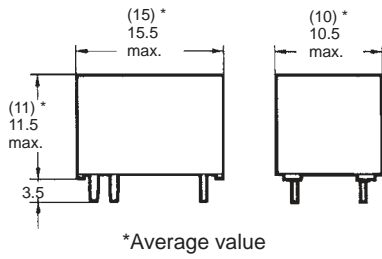
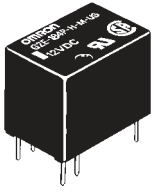

Terminal Arrangement/ Internal Connections (Bottom View)

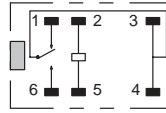

Mounting Holes (Bottom View)

Tolerance: ± 0.1

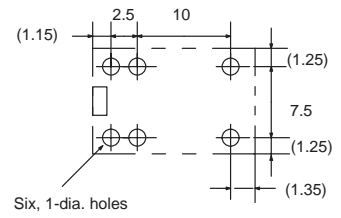

ALL DIMENSIONS SHOWN ARE IN MILLIMETERS.

To convert millimeters into inches, multiply by 0.03937. To convert grams into ounces, multiply by 0.03527.