



Specific Lighting

Product Data Sheet

LTW-E670DS-GE

Created Date: 09 / 04 / 2015
Revision: A, 06 / 12 / 2019

Specific Lighting LTW-E670DS

1. Description

The LTW (LiteOn white PLCC LED) is a revolutionary, energy efficient and ultra compact new light source, combining the lifetime and reliability advantages of Light Emitting Diodes with the brightness of conventional lighting. It gives you total design freedom and unmatched brightness, creating a new opportunities for solid state lighting to displace conventional lighting technologies..

1. Features

- High power LED light source
- Instant light (less than 100 ns)
- Low voltage DC operated
- Low thermal resistance
- RoHS Compliant
- Lead free reflow solder compatible

1.2. Applications

- Reading lights (car, bus, aircraft)
- Portable (flashlight, bicycle)
- Downlighters/Orientation
- Decorative/Entertainment
- Bollards/Security/Garden
- Cove/Undershef/Task
- Traffic signaling/Beacons/ Rail crossing and Wayside
- Indoor/Outdoor Commercial and Residential Architectural

2. Outline Dimensions

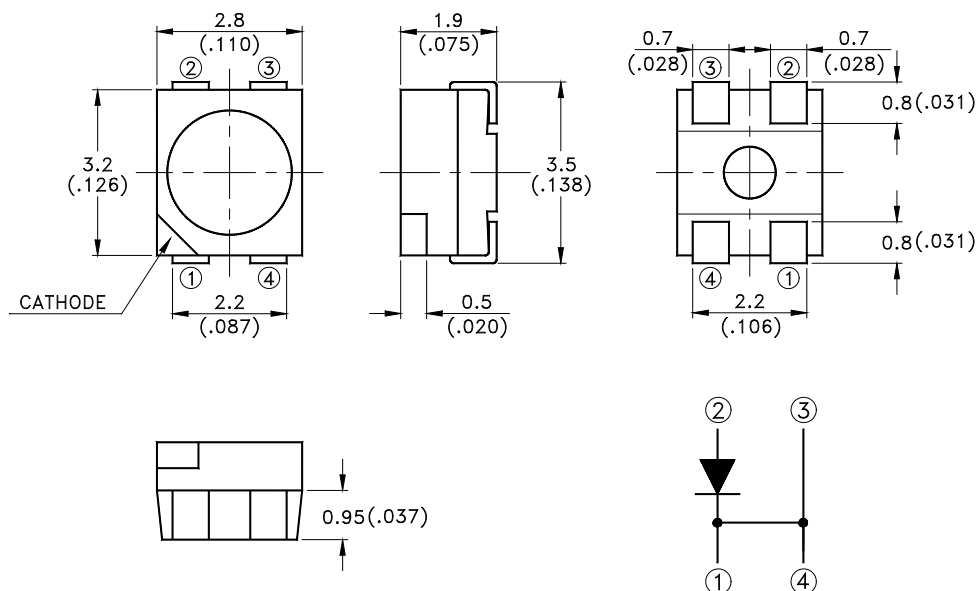

Notes :

1. All dimensions are in millimeters.
2. Tolerance is ± 0.2 mm unless otherwise noted.

Specific Lighting LTW-E670DS

3. Absolute Maximum Ratings at Ta=25°C

Parameter	Symbol	Rating	Unit
Forward Current	I _f	50	mA
Peak Forward Current (Duty 1/10 @ 0.1ms Pulse Width)	I _{FP}	100	mA
Power Consumption	P _D	200	mW
Operating Temp	T _{opr}	-30~85	°C
Storage Temp	T _{stg}	-40~100	°C
Storage Humidity	H _{stg}	10~90	%RH
Reverse Voltage*	V _R	5	V

Note:

*Operating the LED (in an application) under reverse bias condition might result in damage or failure of the component.

4. Suggest IR Reflow Condition

R-Reflow Soldering Profile for lead free soldering (Acc. to J-STD-020D)

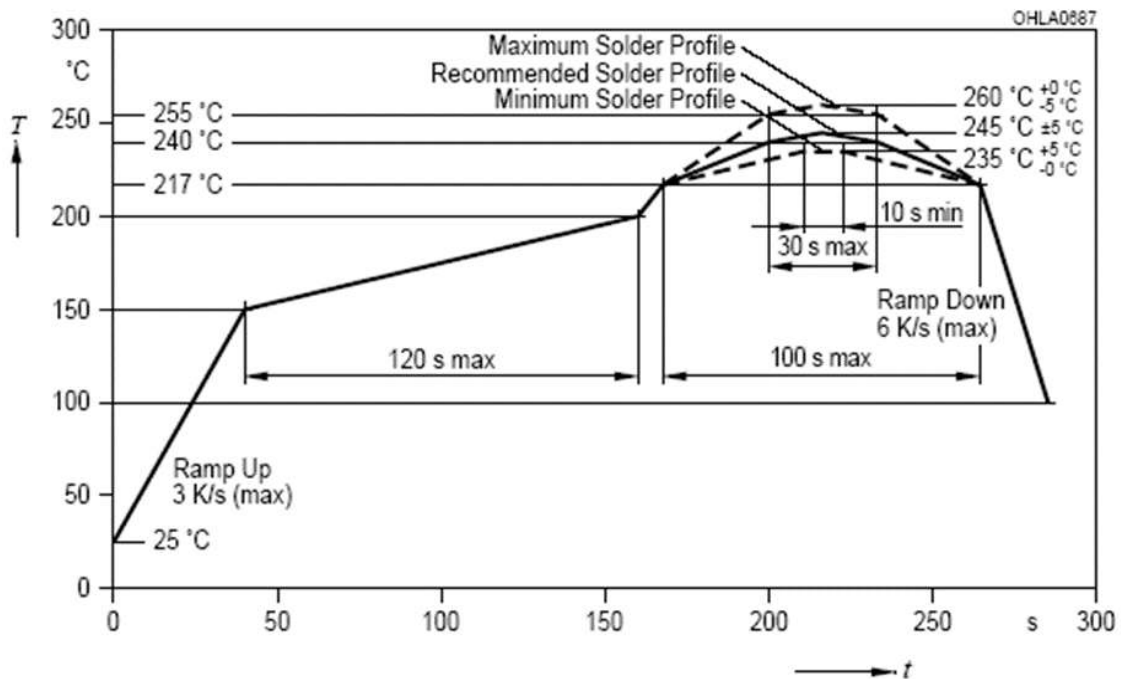

**Specific Lighting
LTW-E670DS**

5. Electro-Optical Characteristics at Ta=25°C

Parameter	Symbol	Values		Test Condition	Unit
Forward Voltage	Vf	Min.	2.7	If = 30mA	V
		Typ.	3.0		
		Max.	3.7		
Luminous Intensity	IV	Min.	1400	If = 30mA	mcd
		Typ.	2900		
		Max	4500		
Viewing Angle	2θ1/2	Typ.	120	If = 30mA	°
Chromaticity Coordinates	x	Typ.	0.32	If = 30mA	
	y	Typ.	0.31		
Reverse Current	IR	Max	10	VR = 5V	uA

Notes

1. Luminous intensity is measured with a light sensor and filter combination that approximates the CIE eye-response curve
2. IV classification code is marked on each packing bag.
3. The chromaticity coordinates (x, y) is derived from the 1931 CIE chromaticity diagram.
4. Caution in ESD: Static Electricity and surge damages the LED. It is recommended using a wrist band or anti-electrostatic glove when handling the LED. All devices, equipment and machinery must be properly grounded.

**Specific Lighting
LTW-E670DS**

6. Bin Code List

6.1 Luminous Intensity Spec

IV Bin	Luminous Intensity (mcd) at $I_f = 30\text{mA}$		Luminous Flux (lm)
	Min.	Max.	Typ.
W2	1400	1400	4.4
X1	1800	1800	5.2
X2	2240	2240	6.0
Y1	2800	2800	6.8
Y2	3550	4500	8.0

Tolerance on each Luminous Intensity bin is +/- 15%.

Specific Lighting
LTW-E670DS

6.2 Hue Spec. Table

Hue Bin	Color bin limits at $I_f = 30\text{mA}$				
	CIE 1931 Chromaticity coordinates				
A	x	0.22	0.22	0.26	0.26
	y	0.22	0.28	0.31	0.25
B	x	0.26	0.26	0.29	0.29
	y	0.25	0.31	0.33	0.27
C	x	0.29	0.29	0.32	0.32
	y	0.27	0.33	0.35	0.29
D	x	0.32	0.32	0.36	0.36
	y	0.29	0.35	0.38	0.32

Tolerance on each Hue (x, y) bin is +/- 0.02

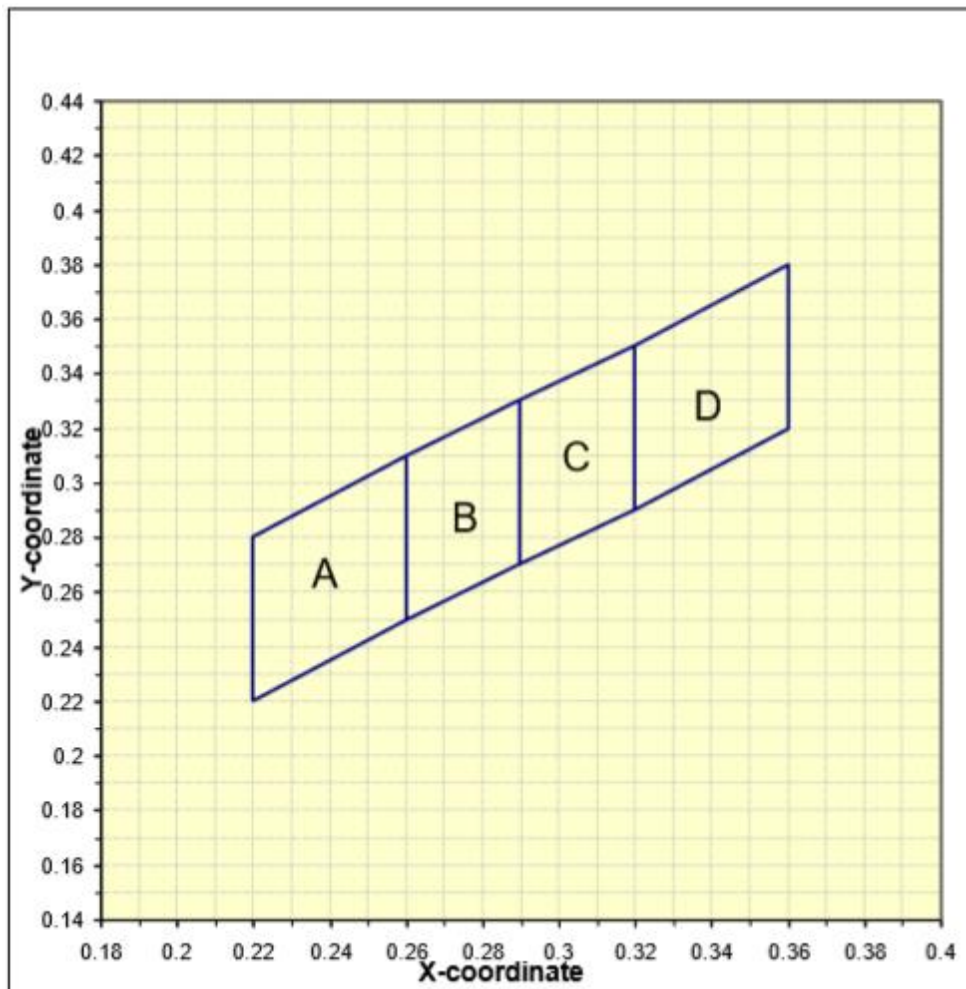

Specific Lighting
LTW-E670DS

7. Typical Electrical / Optical Characteristics Curves
(25°C Ambient Temperature Unless Otherwise Noted)

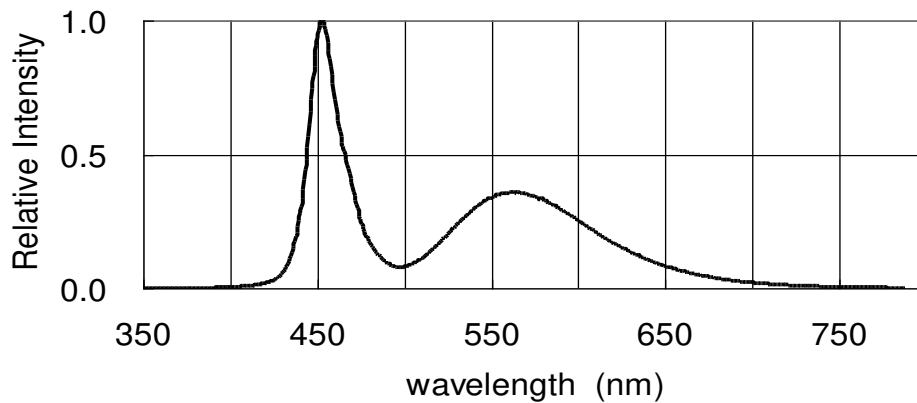

Fig.1 RELATIVE INTENSITY VS. WAVELENGTH

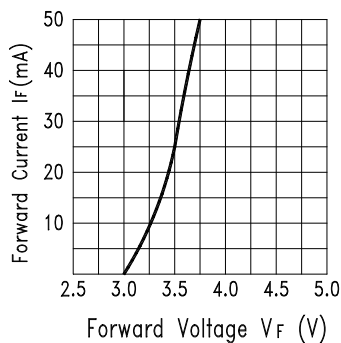

Fig.2 Forward Current vs. Forward Voltage

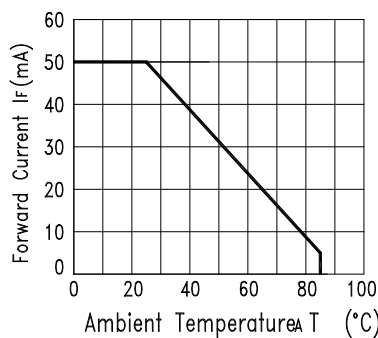

Fig.3 Forward Current Derating Curve

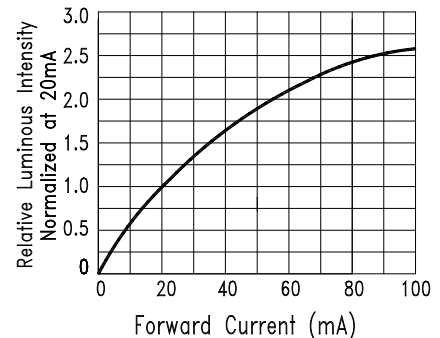

Fig.4 Relative Luminous Intensity vs. Forward Current

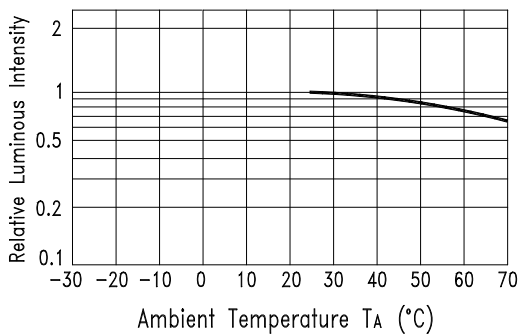

Fig.5 Luminous Intensity vs. Ambient Temperature

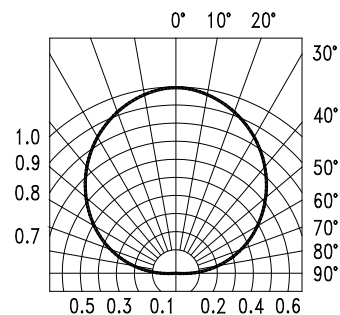

Fig.6 Spatial Distribution

8. User Guide

8.1 Cleaning

Do not use unspecified chemical liquid to clean LED they could harm the package.

If cleaning is necessary, immerse the LED in ethyl alcohol or isopropyl alcohol at normal temperature for less than one minute.

8.2 Recommend Printed Circuit Board Attachment Pad

Infrared / vapor phase

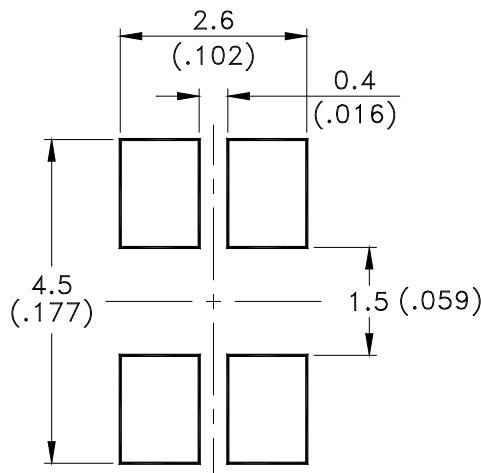

8.3 Package Dimensions of Tape

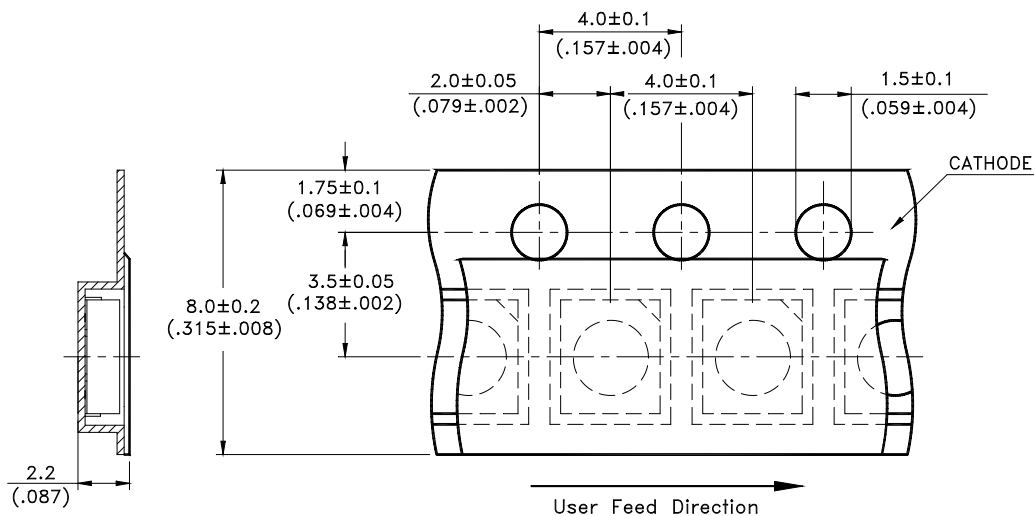

Note All dimensions are in millimeters (inches)

**Specific Lighting
LTW-E670DS**

8.4 Package Dimensions of Reel

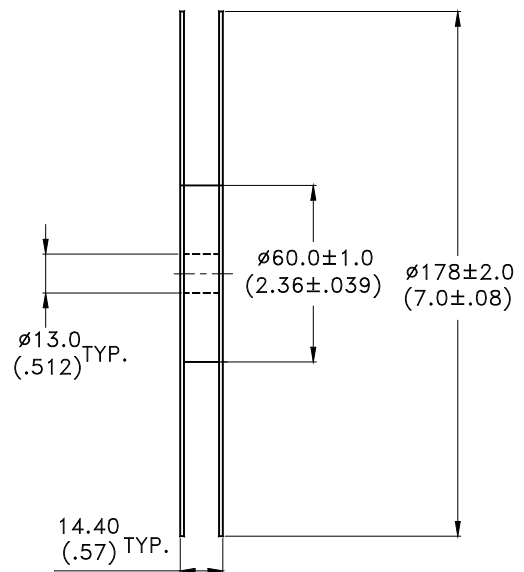
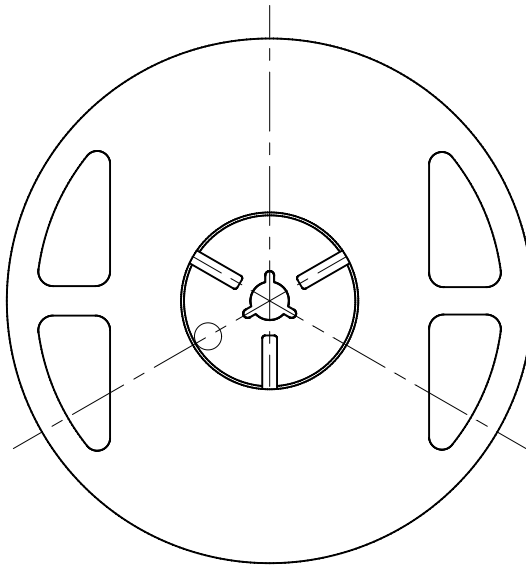

Notes:

1. Empty component pockets sealed with top cover tape.
2. 7 inch reel-maximum 2000 pieces per reel.
3. Minimum packing quantity is 500 pieces for remainders.
4. The maximum number of consecutive missing lamps is two.
5. In accordance with EIA-481-1-B specifications.

Specific Lighting LTW-E670DS

9. CAUTIONS

9.1 Application

The LEDs described here are intended to be used for ordinary electronic equipment (such as office equipment, communication equipment and household applications). Consult Liteon's Sales in advance for information on applications in which exceptional reliability is required, particularly when the failure or malfunction of the LEDs may directly jeopardize life or health (such as in aviation, transportation, traffic control equipment, medical and life support systems and safety devices).

9.2 Storage

This product is qualified as Moisture sensitive Level 4 per JEDEC J-STD-020 Precaution when handling this moisture sensitive product is important to ensure the reliability of the product.

The package is sealed:

The LEDs should be stored at 30°C or less and 90%RH or less. And the LEDs are limited to use within one year, while the LEDs is packed in moisture-proof package with the desiccants inside.

The package is opened:

The LEDs should be stored at 30°C or less and 60%RH or less. Moreover, the LEDs are limited to solder process within 72hrs. If the Humidity Indicator shows the pink color in 10% even higher or exceed the storage limiting time since opened, that we recommended to baking LEDs at 60°C at least 48hrs. To seal the remainder LEDs return to package, it's recommended to be with workable desiccants in original package.

9.3 Cleaning

Use alcohol-based cleaning solvents such as isopropyl alcohol to clean the LED if necessary.

9.4 Soldering

Recommended soldering conditions:

Reflow soldering		Soldering iron	
Pre-heat	150~200°C	Temperature	300°C Max.
Pre-heat time	120 sec. Max.	Soldering time	3 sec. Max.
Soldering Temp.	260°C Max.		(one time only)
Soldering time	30 sec. Max.		

Specific Lighting LTW-E670DS

9.5 Drive Method

An LED is a current-operated device. In order to ensure intensity uniformity on multiple LEDs connected in parallel in an application, it is recommended that a current limiting resistor be incorporated in the drive circuit, in series with each LED as shown in Circuit A below.

Circuit model A

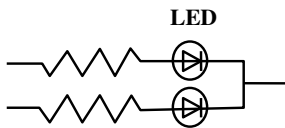

(A) Recommended circuit.

Circuit model B

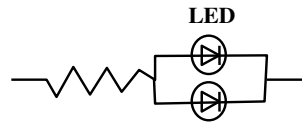

(B) The brightness of each LED might appear different due to the differences in the I-V characteristics of those LEDs.

9.6 ESD (Electrostatic Discharge)

Static Electricity or power surge will damage the LED.

Suggestions to prevent ESD damage:

- Use of a conductive wrist band or anti-electrostatic glove when handling these LEDs.
- All devices, equipment, and machinery must be properly grounded.
- Work tables, storage racks, etc. should be properly grounded.
- Use ion blower to neutralize the static charge which might have built up on surface of the LED's plastic lens as a result of friction between LEDs during storage and handling.

ESD-damaged LEDs will exhibit abnormal characteristics such as high reverse leakage current, low forward voltage, or "no lightup" at low currents.

To verify for ESD damage, check for "light up" and V_f of the suspect LEDs at low currents.

The V_f of "good" LEDs should be $>2.0V@0.1mA$ for InGaN product and $>1.4V@0.1mA$ for AlInGaP product.

Specific Lighting LTW-E670DS

9.7 Reliability Test

Classification	Test Item	Test Condition	Reference Standard
Endurance Test	Operation Life	Ta= Under Room Temperature As Per Data Sheet Maximum Rating *Test Time= 1000HRS (-24HRS,+72HRS)*@30mA.	MIL-STD-750D:1026 MIL-STD-883D:1005 JIS C 7021:B-1
	High Temperature High Humidity Storage	Ta= 65±5°C, RH= 90~95% *Test Time= 240HRS±2HRS	MIL-STD-202F:103B JIS C 7021:B-11
	High Temperature Storage	Ta= 105±5°C *Test Time= 1000HRS (-24HRS,+72HRS)	MIL-STD-883D:1008 JIS C 7021:B-10
	Low Temperature Storage	Ta= -55±5°C *Test Time=1000HRS (-24HRS,+72HRS)	JIS C 7021:B-12
Environmental Test	Temperature Cycling	105°C ~ 25°C ~ -55°C ~ 25°C 30mins 5mins 30mins 5mins 10 Cycles	MIL-STD-202F:107D MIL-STD-750D:1051 MIL-STD-883D:1010 JIS C 7021:A-4
	Thermal Shock	85 ± 5°C ~ -40°C ± 5°C 10mins 10mins 100 Cycles	MIL-STD-202F:107D MIL-STD-750D:1051 MIL-STD-883D:1011
	IR-Reflow	Ramp-up rate(217°C to Peak) +3°C/ second max Temp. maintain at 175(±25)°C 180 seconds max Temp. maintain above 217°C 60-150 seconds Peak temperature range 260°C+0/-5°C Time within 5°C of actual Peak Temperature (tp) 20-40 seconds Ramp-down rate +6°C/second max	MIL-STD-750D:2031.2 J-STD-020B
	Solderability	T.sol= 245 ± 5°C Immersion time 3±0.5 sec Immersion rate 25±2.5 mm/sec Coverage ≥95% of the dipped surface	MIL-STD-202F:208D MIL-STD-750D:2026 MIL-STD-883D:2003 IEC 68 Part 2-20 JIS C 7021:A-2

Specific Lighting LTW-E670DS

9.8 Others

The appearance and specifications of the product may be modified for improvement without prior notice.

9.9 Suggested Checking List

Training and Certification

1. Everyone working in a static-safe area is ESD-certified?
2. Training records kept and re-certification dates monitored?

Static-Safe Workstation & Work Areas

1. Static-safe workstation or work-areas have ESD signs?
2. All surfaces and objects at all static-safe workstation and within 1 ft measure less than 100V?
3. All ionizer activated, positioned towards the units?
4. Each work surface mats grounding is good?

Personnel Grounding

1. Every person (including visitors) handling ESD sensitive (ESDS) items wear wrist strap, heel strap or conductive shoes with conductive flooring?
 2. If conductive footwear used, conductive flooring also present where operator stand or walk?
3. Garments, hairs or anything closer than 1 ft to ESD items measure less than 100V*?
4. Every wrist strap or heel strap/conductive shoes checked daily and result recorded for all DLs?
5. All wrist strap or heel strap checkers calibration up to date?

Note: * 50V for Blue LED.

Device Handling

1. Every ESDS items identified by EIA-471 labels on item or packaging?
2. All ESDS items completely inside properly closed static-shielding containers when not at static-safe workstation?
3. No static charge generators (e.g. plastics) inside shielding containers with ESDS items?
4. All flexible conductive and dissipative package materials inspected before reuse or recycle?

Others

1. Audit result reported to entity ESD control coordinator?
2. Corrective action from previous audits completed?
3. Are audit records complete and on file?