

Features

- Simple Direct Lux Output
- Approximates Human Eye Response in Diverse Lighting Conditions
- Three User-Selectable Integration Times (400 ms, 200 ms, and 100 ms)
- Wide Dynamic Range — 3 lux to 220k lux
- Rejects 50 Hz/60 Hz Lighting Ripple
- Low Active Current (110 μ A typical) with Power Down Mode (2.2 μ A typical) Enables Green Products
- 16-bit Digital Output with I²C Compatibility
- Ultra-Small 2 mm \times 2 mm ChipLED package
- 2.5-V Supply Voltage with 1.8-V Logic Interface

PACKAGE CL
ChipLED
(TOP VIEW)

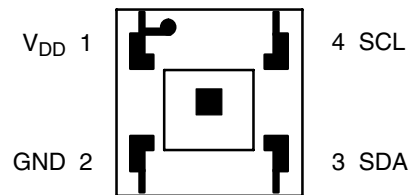

Package Drawing Not to Scale

Applications

- Outdoor Lighting Control
 - Street Lights
 - Security Lights
 - Traffic Signals
 - Commercial Billboards
- Display Backlight Control
 - Automotive Instrumentation
 - Cell Phones
 - Tablets and Notebooks
- Solid-State and General Lighting and Daylight Harvesting
 - Commercial Lighting
 - Industrial Lighting

Description

The TSL4531 family of devices provides ambient light sensing (ALS) that approximates human eye response under a variety of lighting conditions. The devices have three selectable integration times and provide a direct 16-bit lux output via an I²C bus interface. The wide dynamic range of the ALS makes it particularly useful in outdoor applications where it is exposed to direct sunlight. The device is ideal for use in automatic control of street lights and security, billboard, and automotive lighting. The TSL4531 devices can also be used in solid state and general lighting for automatic control and daylight harvesting to maximize energy conservation. Other applications include display backlight control to extend battery life and optimize visibility in cell phones, tablets, and notebooks.

Functional Block Diagram

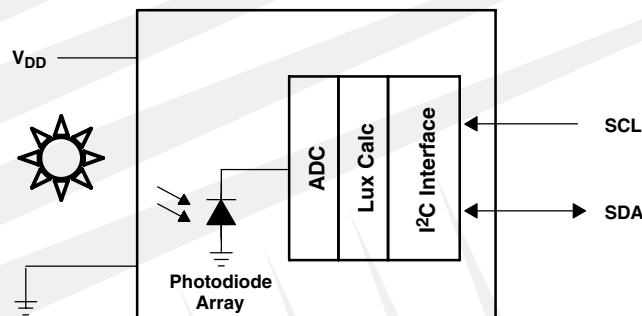

TSL4531

DIGITAL AMBIENT LIGHT SENSOR

TAOS112 – OCTOBER 2011

Detailed Description

The device contains a photodiode array, an integrating analog-to-digital converter (ADC), signal processing circuitry, lux calculation logic, and an I²C serial interface on a single CMOS integrated circuit to provide lux data with a 16-bit output. No external circuitry is required for signal conditioning. The device features power management modes where the user can select continuous operation, power save mode in which the device inserts a power saving state between each acquisition, or single-cycle operation in which the device enters a power-down state after data acquisition. The device has three user-selectable integration times of 100 ms, 200 ms, or 400 ms, allowing the user to adjust the sensitivity of the device.

Terminal Functions

TERMINAL NAME	NO.	TYPE	DESCRIPTION
GND	2		Power supply ground. All voltages are referenced to GND.
SCL	4	I	I ² C serial clock input terminal.
SDA	3	I/O	I ² C serial data I/O terminal — bidirectional.
V _{DD}	1		Supply voltage.

Available Options

DEVICE	ADDRESS	PACKAGE – LEADS	INTERFACE DESCRIPTION	ORDERING NUMBER
TSL45311†	0x39	CL-4	I ² C V _{bus} = V _{DD} Interface	TSL45311CL
TSL45313†	0x39	CL-4	I ² C V _{bus} = 1.8 V Interface	TSL45313CL
TSL45315†	0x29	CL-4	I ² C V _{bus} = V _{DD} Interface	TSL45315CL
TSL45317	0x29	CL-4	I ² C V _{bus} = 1.8 V Interface	TSL45317CL

† Contact TAOS for availability.

Absolute Maximum Ratings over operating free-air temperature range (unless otherwise noted)†

Supply voltage, V _{DD} (Note 1)	4.5 V
Input terminal voltage	-0.5 V to 4.5 V
Output terminal voltage	-0.5 V to 4.5 V
Output terminal current	-1 mA to 20 mA
Storage temperature range, T _{stg}	-40°C to 85°C
ESD tolerance, human body model	2000 V

† Stresses beyond those listed under “absolute maximum ratings” may cause permanent damage to the device. These are stress ratings only, and functional operation of the device at these or any other conditions beyond those indicated under “recommended operating conditions” is not implied. Exposure to absolute-maximum-rated conditions for extended periods may affect device reliability.

NOTE 1: All voltage values are with respect to GND.

Recommended Operating Conditions

	MIN	NOM	MAX	UNIT
Supply voltage, V _{DD}	2.3	2.5	3.3	V
Operating free-air temperature, T _A	-15		70	°C

Operating Characteristics, $V_{DD} = 2.5\text{ V}$, $T_A = 25^\circ\text{C}$ (unless otherwise noted)

PARAMETER	TEST CONDITIONS	MIN	TYP	MAX	UNIT
I_{DD} Supply current	Active (Note 1)		110	130	μA
	Power down — no I ² C activity		2.2	4	
I_{LEAK} Leakage current, SDA and SCL pins		-5		5	μA
V_{IH} SCL, SDA input high voltage	TSL45311, TSL45315	0.7 V_{DD}			V
	TSL45313, TSL45317	1.25			
V_{IL} SCL, SDA input low voltage	TSL45311, TSL45315	0.3 V_{DD}			V
	TSL45313, TSL45317	0.54			

NOTE 1: The average supply current will be slightly lower when PSAVESKIP = 0.

ALS Characteristics, $V_{DD} = 2.5\text{ V}$, $T_A = 25^\circ\text{C}$, TCNTRL = 1× (Tint = 400 ms) (unless otherwise noted)

PARAMETER	TEST CONDITIONS	MIN	TYP	MAX	UNIT
ADC count value		0		65535	counts
ADC count value	$\lambda_p = \text{white LED, CCT} = 4000\text{K, } E_v = 1000\text{ lux}$	1000			counts
	$\lambda_p = 880\text{ nm} + 940\text{ nm, } E_e = 345\ \mu\text{W}/\text{cm}^2$ (Note 1)	3			
ADC count value ratio	Inc std A/Fluorescent F12 (Notes 2 & 4)	80		120	%
Sensor output responsivity	$\lambda_p = \text{white LED, CCT} = 4000\text{K}$	0.8	1	1.2	count/lux
Dynamic range	Incandescent light source: STD A (Notes 3 & 4)	3		220k	lux
Temperature coefficient	-15°C to 0°C	-0.25		0	% / °C
	0°C to 70°C	-0.20		0	
Integration time	TCNTRL = 10	96	100	104	ms
	TCNTRL = 01	192	200	208	
	TCNTRL = 00	384	400	416	
Total cycle time	TCNTRL = 10, PSAVESKIP = 0 (Note 5)	110.4	115	119.6	ms
	TCNTRL = 01, PSAVESKIP = 0 (Note 5)	220.8	230	239.2	
	TCNTRL = 00, PSAVESKIP = 0 (Note 5)	441.6	460	478.4	

- NOTES: 1. Combination of IR LEDs used with peak wavelengths of 880 nm and 940 nm for IR rejection production test.
 2. Incandescent STD A light source at 300 lux. Fluorescent F12 light source at 300 lux.
 3. 220,000 lux reading possible with TCNTRL set to 4× MULTIPLIER (Tint = 100 ms).
 4. Not tested in production.
 5. When PSAVESKIP = 1, total cycle time equals integration time.

TSL4531 DIGITAL AMBIENT LIGHT SENSOR

TAOS112 – OCTOBER 2011

AC Electrical Characteristics, $V_{DD} = 2.5\text{ V}$, $T_A = 25^\circ\text{C}$ (unless otherwise noted)

PARAMETER†		TEST CONDITIONS	MIN	TYP	MAX	UNIT
$f_{(SCL)}$	Clock frequency				400	kHz
$t_{(BUF)}$	Bus free time between start and stop condition		4.7			μs
$t_{(HDSTA)}$	Hold time after (repeated) start condition. After this period, the first clock is generated.		4			μs
$t_{(SUSTA)}$	Repeated start condition setup time		4.7			μs
$t_{(SUSTO)}$	Stop condition setup time		4			μs
$t_{(HDDAT)}$	Data hold time		300			ns
$t_{(SUDAT)}$	Data setup time		250			ns
$t_{(LOW)}$	SCL clock low period		4.7			μs
$t_{(HIGH)}$	SCL clock high period		4			μs
$t_{(TIMEOUT)}$	Detect clock/data low timeout		25		35	ms
t_F	Clock/data fall time				300	ns
t_R	Clock/data rise time				1000	ns
C_i	Input pin capacitance				10	pF

† Specified by design and characterization — not production tested.

PARAMETER MEASUREMENT INFORMATION

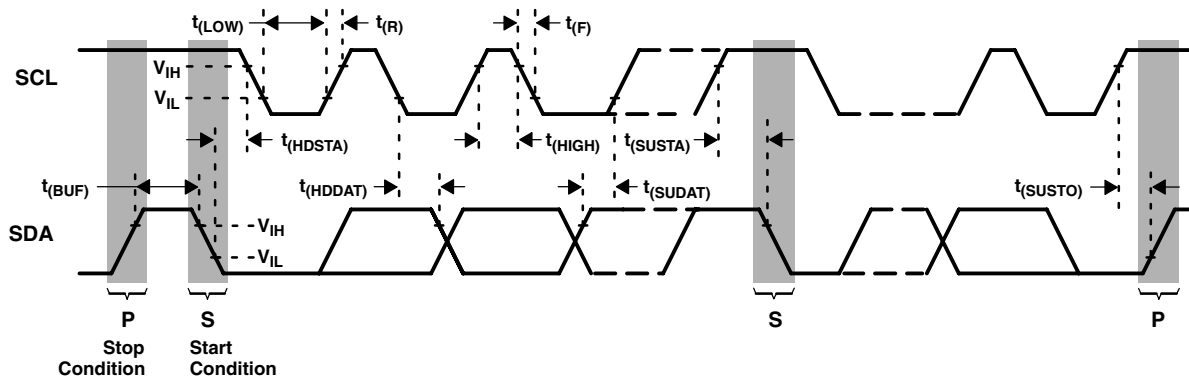

Figure 1. Timing Diagrams



TYPICAL CHARACTERISTICS

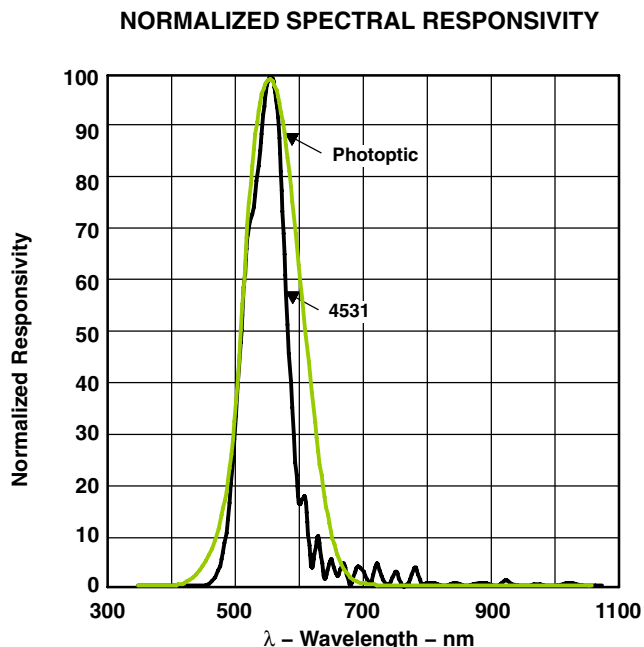

Figure 2

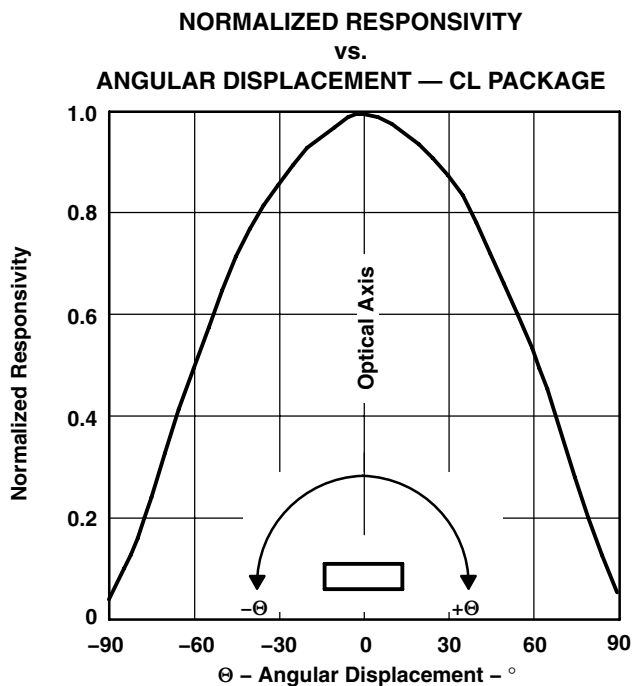

Figure 3

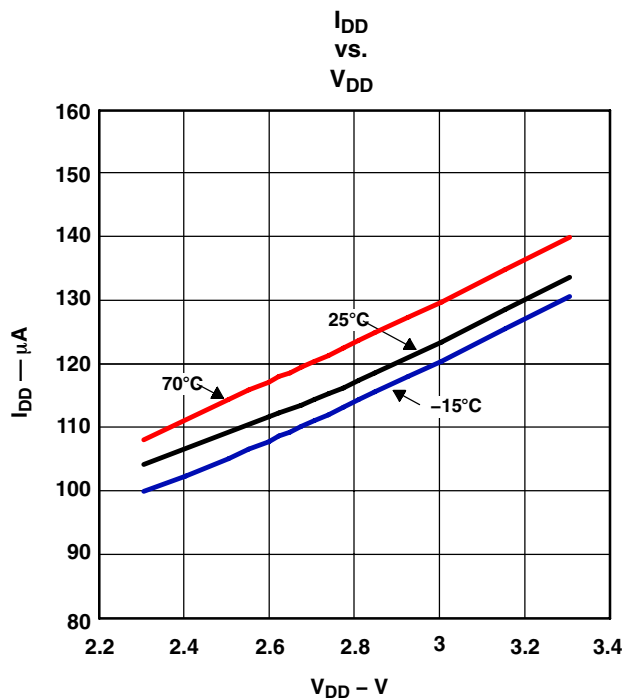

Figure 4

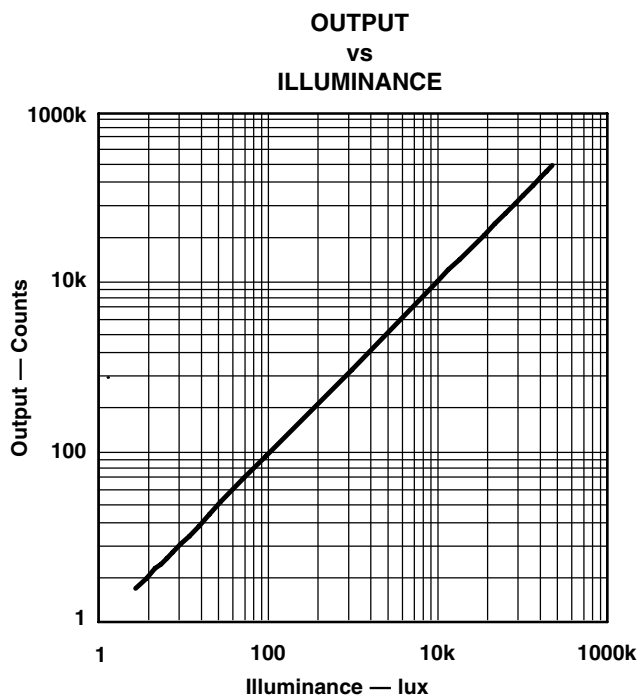

Figure 5

PRINCIPLES OF OPERATION

Analog-to-Digital Converter

The TSL4531 contains one integrating analog-to-digital converter (ADC) that integrates the current from the photodiode array. Upon completion of the conversion cycle, the conversion result is transferred to the data registers. Transfers are double-buffered to ensure that invalid data is not read during the transfer. After the transfer, the device will either automatically begin another integration cycle, or enter power-down mode, depending upon the mode setting in the control register.

The device features several key power management features. The mode of operation can be controlled to provide either continuous operation or single acquisition operation followed by a power-down state. In the continuous operation, a secondary mode can be enabled allowing the device to go into a low-power state in between each acquisition cycle.

The device allows the user to control the integration time. This enables the user to control the sensitivity of the device to allow for the greater dynamic range needed in bright lighting conditions such as sunlight. Integration times of 400 ms, 200 ms, or 100 ms are available. All integration times are multiples of 50 ms, allowing rejection of 50/60-Hz ripple present in a typical fluorescent lights. The lux output needs to be scaled depending on the integration time as shown in the calculating lux section.

Calculating Lux

The ADC output is a 16-bit number that is directly proportional to the value that approximates the human eye response in the commonly used illuminance unit of lux. The light level can be calculated using the following expression.

$$\text{Light Level (lux)} = \text{MULTIPLIER} \times [(\text{DATAHIGH} \ll 8) + \text{DATALOW}]$$

Where: MULTIPLIER = 1 for TCNTRL = 00 (Tint = 400 ms),
MULTIPLIER = 2 for TCNTRL = 01 (Tint = 200 ms), and
MULTIPLIER = 4 for TCNTRL = 10 (Tint = 100 ms), and
<< 8 indicates a logical 8-bit shift left operation, and
TCNTRL is a 2-bit field in the configuration register (0x01)

Example:

MULTIPLIER = 1
DATALOW = 0x9C
DATAHIGH = 0x63

$$\begin{aligned} \text{Illuminance} &= 1 \times [(\text{DATAHIGH} \ll 8) + \text{DATALOW}] \text{ lux} \\ &= (0x63 \ll 8) + 0x9C \text{ lux} \\ &= 0x639C \text{ lux} \\ &= 25,500 \text{ lux} \end{aligned}$$

I²C Protocol

Interface and control are accomplished through an I²C serial compatible interface (standard or fast mode) to a set of registers that provide access to device control functions and output data. The devices support the 7-bit I²C addressing protocol.

The I²C standard provides for three types of bus transaction: read, write, and a combined protocol (Figure 6). During a write operation, the first byte written is a command byte followed by data. In a combined protocol, the first byte written is the command byte followed by reading a series of bytes. If a read command is issued, the register address from the previous command will be used for data access. Likewise, if the MSB of the command is not set, the device will write a series of bytes at the address stored in the last valid command with a register address. The command byte contains either control information or a 5-bit register address. The control commands can also be used to clear interrupts.

The I²C bus protocol was developed by Philips (now NXP). For a complete description of the I²C protocol, please review the NXP I²C design specification at <http://www.i2c-bus.org/references/>.

- A Acknowledge (0)
- N Not Acknowledged (1)
- P Stop Condition
- R Read (1)
- S Start Condition
- Sr Repeated Start Condition
- W Write (0)
- ... Continuation of protocol
- Master-to-Slave
- Slave-to-Master

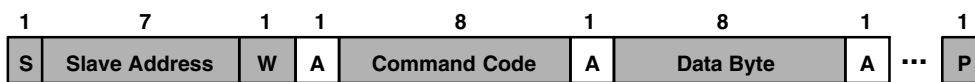

I²C Write Protocol

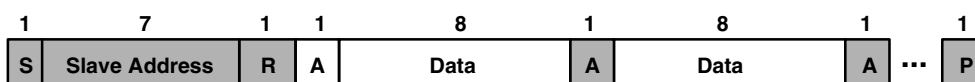

I²C Read Protocol

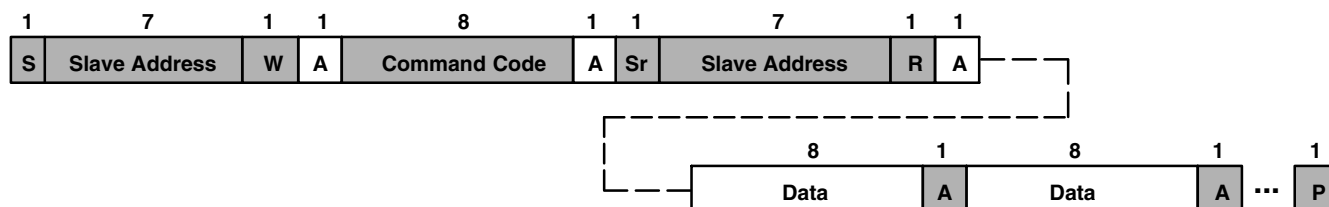

I²C Read Protocol — Combined Format

Figure 6. I²C Protocols

TSL4531 DIGITAL AMBIENT LIGHT SENSOR

TAOS112 – OCTOBER 2011

Register Set

The device is controlled and monitored by data registers and a command register accessed through the serial interface. These registers provide for a variety of control functions and can be read to determine results of the ADC conversions.

Table 1. Register Set

ADDRESS	REGISTER NAME	R/W	REGISTER FUNCTION	RESET VALUE
---	COMMAND	W	Specifies register address	0x00
0x00	CONTROL	R/W	Power on/off and single cycle	0x00
0x01	CONFIG	R/W	Powersave Enable / Integration Time	0x00
0x04	DATALOW	R	ALS Data LOW Register	0x00
0x05	DATAHIGH	R	ALS Data HIGH Register	0x00
0x0A	ID	R	Device ID	ID

The mechanics of accessing a specific register depends on the specific protocol used. See the section on I²C protocols on the previous pages. In general, the COMMAND register is written first to specify the specific control/status register for following read/write operations.

There are 16 register locations, but only 5 registers are implemented. To make the register read process more efficient when reading multiple bytes of data as in the combined format protocol, the address index pointer is automatically incremented to skip over the unused registers, as shown in Figure 7.

Address in hex

Address increments by 1 except where noted:

Cycle is 0h, Ah, Bh, Ch, Dh, 0h

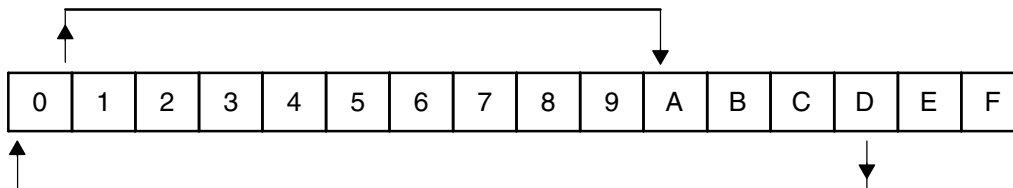

Figure 7. Combined Format Read Cycle Pattern

Command Register

The command register specifies the address of the target register for future write and read operations. It contains two user fields as described below and defaults to 0x00 at power-on.

Table 2. Command Register

	7	6	5	4	3	2	1	0
COMMAND	COMMAND	Reserved			ADDRESS			
FIELD	BITS		DESCRIPTION					
COMMAND	7		Select Command Register. Must write as 1.					
Reserved	6:4		Reserved. Write as 0.					
ADDRESS	3:0		Address register. Selects the specific register for write and read transactions that follow.					

Control Register (0x00)

The CONTROL register is used to power the device on/off and single cycle.

Table 3. Control Register

	7	6	5	4	3	2	1	0	
CONTROL	Reserved							MODE	Reset 0x00

FIELD	BITS	DESCRIPTION	
Reserved	7:2	Reserved. Write as 0.	
MODE	1:0	Operating Mode. This two-bit field controls the mode of the device:	
		FIELD VALUE	FUNCTION
		00	Power Down
		01	Reserved
		10	Run a single ADC cycle and return to PowerDown
	11	Normal Operation	

Configuration Register (0x01)

The configuration register controls the integration timer and power saving enabling through two user fields.

Table 4. Configuration Register

	7	6	5	4	3	2	1	0	
CONFIG	Reserved				PSAVESKIP	Reserved	TCNTRL		Reset 0x00

FIELD	BITS	DESCRIPTION		
Reserved	7:4	Reserved. Write as 0.		
PSAVESKIP	3	PowerSave Mode. When asserted, the power save states are skipped following a light integration cycle for shorter sampling rates (Note A).		
Reserved	2	Reserved. Write as 0.		
TCNTRL	1:0	Timer Control sets the integration time.		
		FIELD VALUE	MULTIPLIER	PURPOSE
		00	1 ×	$T_{int} = 400 \text{ ms}$
		01	2 ×	$T_{int} = 200 \text{ ms}$
		10	4 ×	$T_{int} = 100 \text{ ms}$
	11	--	Reserved	

NOTES: A. When PSAVESKIP = 0, the typical total cycle time is $T_{int} + (60/MULTIPLIER)$ ms. When PSAVESKIP = 1, the typical total cycle time is T_{int} .

TSL4531

DIGITAL AMBIENT LIGHT SENSOR

TAOS112 – OCTOBER 2011

ALS Data Registers (0x04 – 0x05)

The ADC data is expressed as a 16-bit word stored in two 8-bit registers. The read-only ADC data registers DATALOW and DATAHIGH provide the low and high bytes, respectively, of the 16-bit ADC conversion value. The conversion value translates directly to units of lux.

Table 5. ALS Data Registers

REGISTER	ADDRESS	BITS	DESCRIPTION
DATALOW	0x04	7:0	ADC conversion low byte
DATAHIGH	0x05	7:0	ADC conversion high byte

ID Register (0x0A)

The ID register is a read-only register that provides the value for the part number. The PARTNO field indicates the part number of each device given in the Available Options section and will remain constant.

Table 6. ID Register

	7	6	5	4	3	2	1	0	
CONTROL	PARTNO				Reserved				Reset ID

FIELD	BITS	DESCRIPTION	
PARTNO	7:4	FIELD VALUE	DEVICE PART NUMBER
		1000	TSL45317
		1001	TSL45313
		1010	TSL45315
		1011	TSL45311
Reserved	3:0	Reserved	

The ID register is useful for validating the device type and for verifying the functionality of the interface. When used for this purpose, it is recommended that the Reserved field be masked out as follows:

Value = ID AND 0xF0, where AND represents a bit-wise AND function

HARDWARE APPLICATION INFORMATION

Power Supply Decoupling

The power supply lines must be decoupled with a 0.1- μ F capacitor placed as close to the device package as possible. The bypass capacitor should have low effective series resistance (ESR) and effective series inductance (ESI), such as the common ceramic types, which provide a low impedance path to ground at high frequencies to handle transient currents caused by internal logic switching.

PCB Pad Layout

Suggested PCB pad layout guidelines for the CL package is shown in Figure 8.

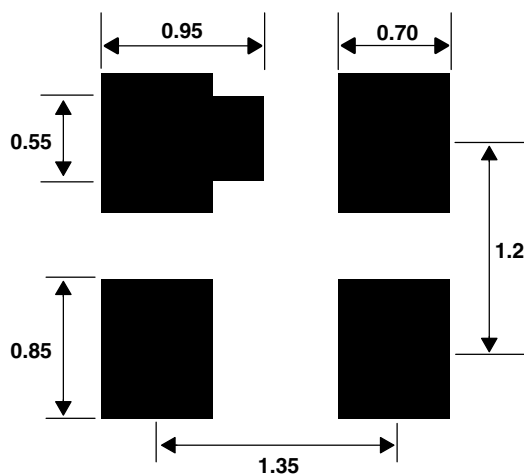

- NOTES: A. All linear dimensions are in millimeters.
B. This drawing is subject to change without notice.

Figure 8. Suggested CL Package PCB Layout

TSL4531 DIGITAL AMBIENT LIGHT SENSOR

TAOS112 – OCTOBER 2011

PACKAGE INFORMATION

PACKAGE CL

ChipLED

TOP VIEW

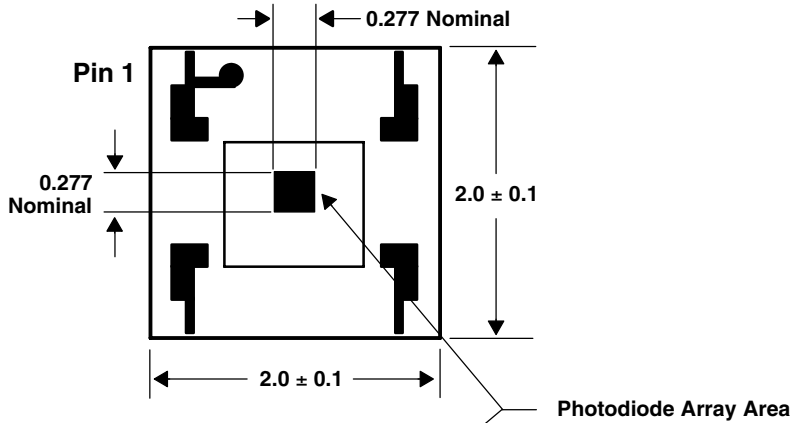

PIN OUT
TOP VIEW

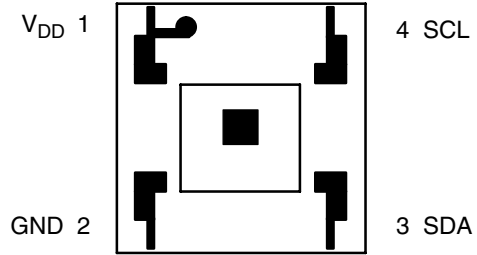

END VIEW

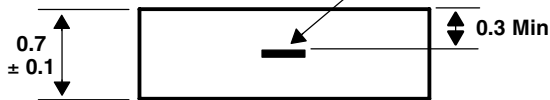

BOTTOM VIEW

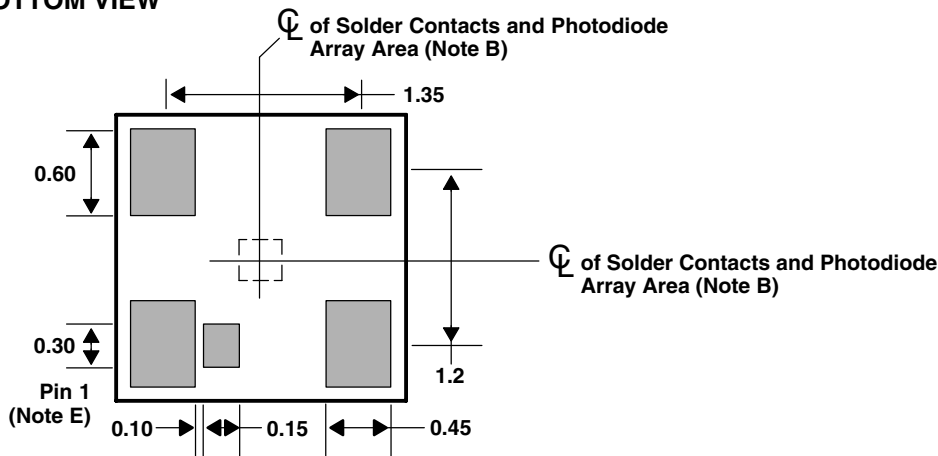

- NOTES:
- A. All linear dimensions are in millimeters.
 - B. The die is offset within the package to center the photodiode array to the solder contacts within a tolerance of $\pm 50 \mu\text{m}$.
 - C. Package top surface is molded with an electrically nonconductive yellow clear plastic compound having an index of refraction of 1.55.
 - D. Contact finish is copper alloy A194 with pre-plated NiPdAu lead finish.
 - E. Bottom pin 1 indicator is electrically connected to pin 1.
 - F. This package contains no lead (Pb).
 - G. This drawing is subject to change without notice.

Figure 9. Package CL — ChipLED Packaging Configuration

CARRIER TAPE AND REEL INFORMATION

TOP VIEW

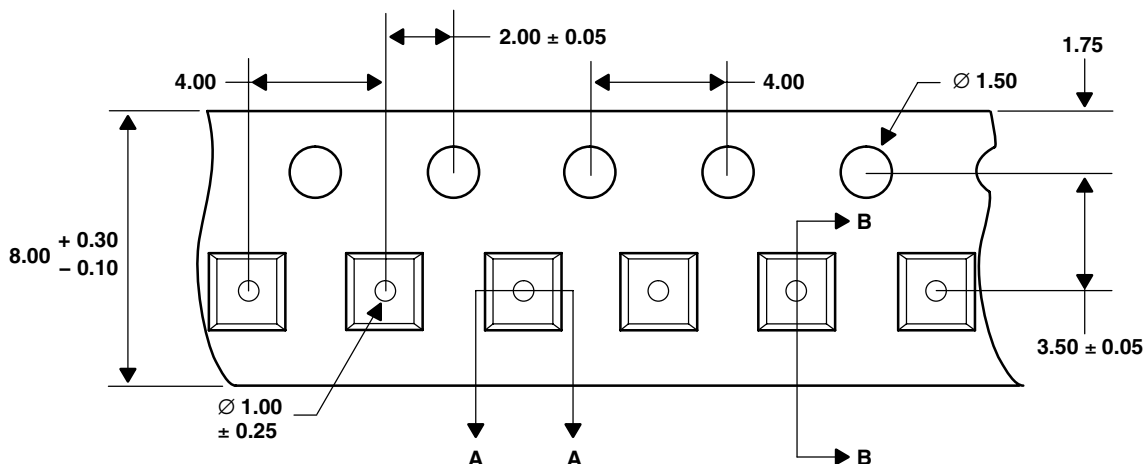

DETAIL A

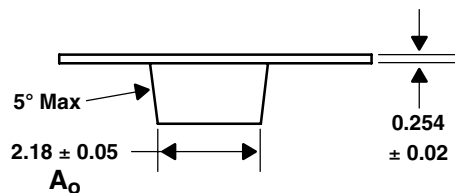

DETAIL B

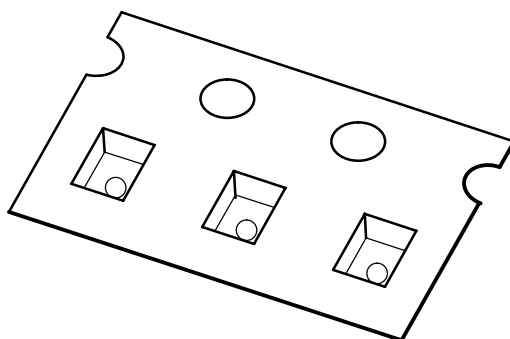
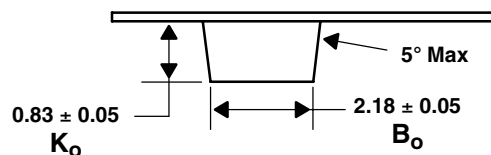

- NOTES: A. All linear dimensions are in millimeters. Dimension tolerance is ± 0.10 mm unless otherwise noted.
 B. The dimensions on this drawing are for illustrative purposes only. Dimensions of an actual carrier may vary slightly.
 C. Symbols on drawing A_o , B_o , and K_o are defined in ANSI EIA Standard 481-B 2001.
 D. Each reel is 178 millimeters in diameter and contains 3500 parts.
 E. TAOS packaging tape and reel conform to the requirements of EIA Standard 481-B.
 F. In accordance with EIA standard, device pin 1 is located next to the sprocket holes in the tape.
 G. This drawing is subject to change without notice.

Figure 10. Package CL Carrier Tape

SOLDERING INFORMATION

The CL package has been tested and has demonstrated an ability to be reflow soldered to a PCB substrate.

The solder reflow profile describes the expected maximum heat exposure of components during the solder reflow process of product on a PCB. Temperature is measured on top of component. The components should be limited to a maximum of three passes through this solder reflow profile.

Table 7. Solder Reflow Profile

PARAMETER	REFERENCE	DEVICE
Average temperature gradient in preheating		2.5°C/sec
Soak time	t_{soak}	2 to 3 minutes
Time above 217°C (T1)	t_1	Max 60 sec
Time above 230°C (T2)	t_2	Max 50 sec
Time above $T_{peak} - 10^\circ\text{C}$ (T3)	t_3	Max 10 sec
Peak temperature in reflow	T_{peak}	260° C
Temperature gradient in cooling		Max -5°C/sec

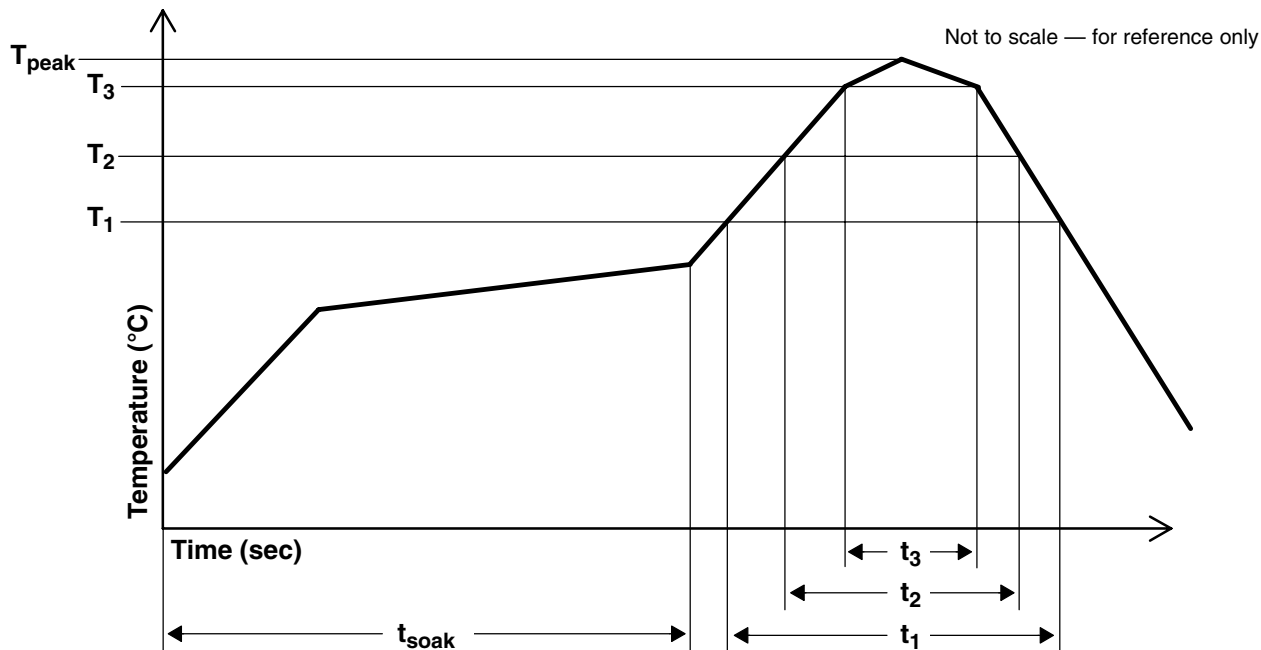

Figure 11. Solder Reflow Profile Graph

STORAGE INFORMATION

Moisture Sensitivity

Optical characteristics of the device can be adversely affected during the soldering process by the release and vaporization of moisture that has been previously absorbed into the package. To ensure the package contains the smallest amount of absorbed moisture possible, each device is baked prior to being dry packed for shipping. Devices are dry packed in a sealed aluminized envelope called a moisture-barrier bag with silica gel to protect them from ambient moisture during shipping, handling, and storage before use.

Shelf Life

The calculated shelf life of the device in an unopened moisture barrier bag is 12 months from the date code on the bag when stored under the following conditions:

Shelf Life: 12 months
Ambient Temperature: < 40°C
Relative Humidity: < 90%

Rebaking of the devices will be required if the devices exceed the 12 month shelf life or the Humidity Indicator Card shows that the devices were exposed to conditions beyond the allowable moisture region.

Floor Life

The CL package has been assigned a moisture sensitivity level of MSL 3. As a result, the floor life of devices removed from the moisture barrier bag is 168 hours from the time the bag was opened, provided that the devices are stored under the following conditions:

Floor Life: 168 hours
Ambient Temperature: < 30°C
Relative Humidity: < 60%

If the floor life or the temperature/humidity conditions have been exceeded, the devices must be rebaked prior to solder reflow or dry packing.

Rebaking Instructions

When the shelf life or floor life limits have been exceeded, rebake at 50°C for 12 hours.

TSL4531

DIGITAL AMBIENT LIGHT SENSOR

TAOS112 – OCTOBER 2011

PRODUCTION DATA — information in this document is current at publication date. Products conform to specifications in accordance with the terms of Texas Advanced Optoelectronic Solutions, Inc. standard warranty. Production processing does not necessarily include testing of all parameters.

LEAD-FREE (Pb-FREE) and GREEN STATEMENT

Pb-Free (RoHS) TAOS' terms *Lead-Free* or *Pb-Free* mean semiconductor products that are compatible with the current RoHS requirements for all 6 substances, including the requirement that lead not exceed 0.1% by weight in homogeneous materials. Where designed to be soldered at high temperatures, TAOS Pb-Free products are suitable for use in specified lead-free processes.

Green (RoHS & no Sb/Br) TAOS defines *Green* to mean Pb-Free (RoHS compatible), and free of Bromine (Br) and Antimony (Sb) based flame retardants (Br or Sb do not exceed 0.1% by weight in homogeneous material).

Important Information and Disclaimer The information provided in this statement represents TAOS' knowledge and belief as of the date that it is provided. TAOS bases its knowledge and belief on information provided by third parties, and makes no representation or warranty as to the accuracy of such information. Efforts are underway to better integrate information from third parties. TAOS has taken and continues to take reasonable steps to provide representative and accurate information but may not have conducted destructive testing or chemical analysis on incoming materials and chemicals. TAOS and TAOS suppliers consider certain information to be proprietary, and thus CAS numbers and other limited information may not be available for release.

NOTICE

Texas Advanced Optoelectronic Solutions, Inc. (TAOS) reserves the right to make changes to the products contained in this document to improve performance or for any other purpose, or to discontinue them without notice. Customers are advised to contact TAOS to obtain the latest product information before placing orders or designing TAOS products into systems.

TAOS assumes no responsibility for the use of any products or circuits described in this document or customer product design, conveys no license, either expressed or implied, under any patent or other right, and makes no representation that the circuits are free of patent infringement. TAOS further makes no claim as to the suitability of its products for any particular purpose, nor does TAOS assume any liability arising out of the use of any product or circuit, and specifically disclaims any and all liability, including without limitation consequential or incidental damages.

TEXAS ADVANCED OPTOELECTRONIC SOLUTIONS, INC. PRODUCTS ARE NOT DESIGNED OR INTENDED FOR USE IN CRITICAL APPLICATIONS IN WHICH THE FAILURE OR MALFUNCTION OF THE TAOS PRODUCT MAY RESULT IN PERSONAL INJURY OR DEATH. USE OF TAOS PRODUCTS IN LIFE SUPPORT SYSTEMS IS EXPRESSLY UNAUTHORIZED AND ANY SUCH USE BY A CUSTOMER IS COMPLETELY AT THE CUSTOMER'S RISK.

LUMENOLOGY, TAOS, the TAOS logo, and Texas Advanced Optoelectronic Solutions are registered trademarks of Texas Advanced Optoelectronic Solutions Incorporated.