

Ratings

Temperature: -40~70 °C
Voltage: 150 V

Conductor

Gauge: 18 AWG 0.82 mm²
Material: tinned copper strands
Strand size: $\varnothing 0.127 \times 65$
Resistance at 20 °C: 23.2 Ω /km max

Insulator

Material: HDPE
Color: brown, gray, purple, orange, green, blue, yellow, white, black, red
Diameter: $\varnothing 1.65 \pm 0.10$ mm
Nominal thickness: 0.23 mm
Resistance at 20 °C: 100 M Ω /km min

Shield

Type: spiral
Material: tinned copper strands
Stranding: $\varnothing 0.08$ mm
Coverage: 90 % min

Outer jacket

Material: TPU
Color: black
Nominal thickness: 0.76 mm
Diameter: $\varnothing 8.3 \pm 0.30$ mm

Filler

Material: aramid fiber

Tests

Tensile strength: 35.7 kgf min
Dielectric test: 1500 V dc for 1 minute without breakdown
Bend test at 200 g, $\pm 90^\circ$, 30 cycles /min: 15,000 cycle minimum

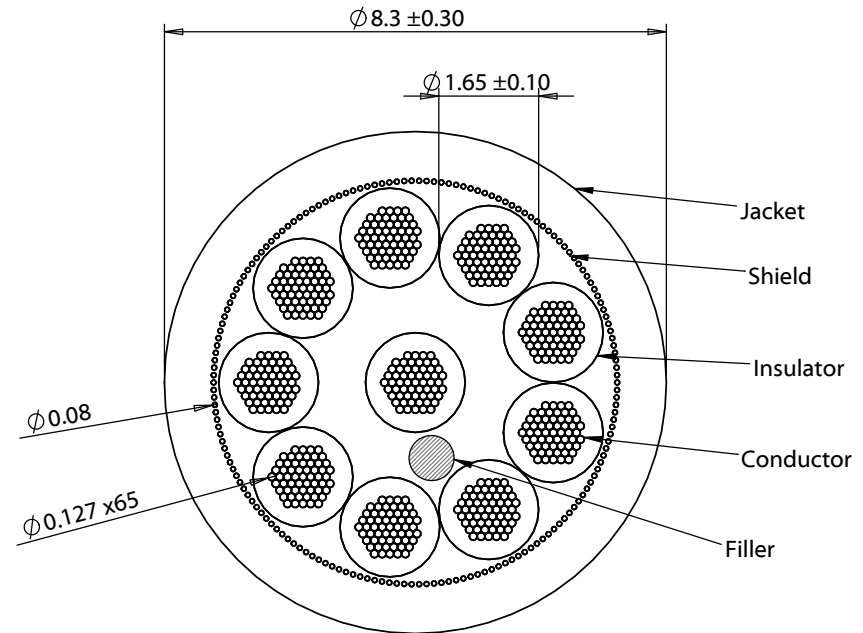
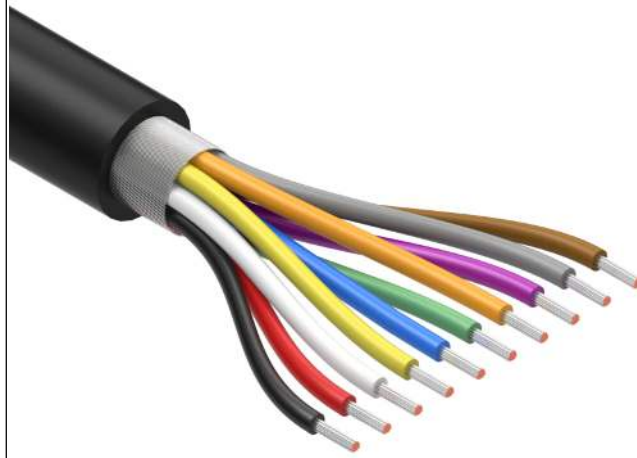

Revision:	Date:	Description:
A	3/23/2021	Initial release

Prepared: AW <small>Digitally signed by AW Date: 2021.03.23 15:17:59 -07'00'</small>
Verified: AG <small>Digitally signed by AG Date: 2021.04.01 12:12:41 -07'00'</small>
Dimensions are in millimeters. Tolerances: X: ± 0.5 mm X.X: ± 0.3 mm X.XX: ± 0.05 mm

Notes: RoHS compliant Jacket meets ISO 10993 Biological Compatibility Phthalate and halogen free Function test: no open, no short, no intermittent
Description: Wire, 10C TS, 18 AWG, 150V, 70C, 8.3 mm, shielded, TPU, 75A, WBL

TENSILITY	
tel 1.541.323.3228	800 877.670.7118
fax 1.541.323.4202	web tensility.com
Size: A	Part number: 30-01882
Scale: 8:1	Sheet 1 of 1