

DATE	REV	ECN	APP'D. BY
9-15-15	A6	10418	SMN
2-26-16	A7	10568	TRM
1-17-17	A8	10864	TRM

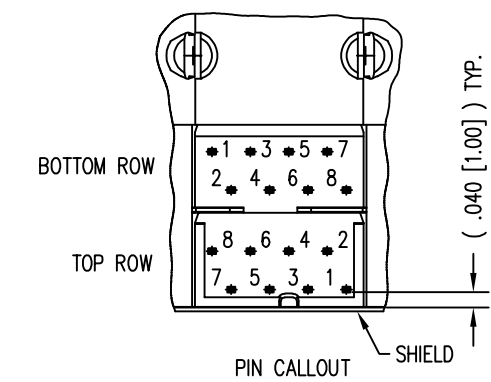

- NOTES:
- CONNECTOR MATERIALS:
HOUSING: THERMOPLASTIC UL94 V-0
CONTACTS/SHIELD: COPPER ALLOY
CONTACT PLATING: SELECTIVE GOLD IN CONTACT AREA
SEE CHART FOR PART NUMBER
SHIELD PLATING: NICKEL
 - FOR PRODUCT SPECIFICATION SEE PRO22-01.
 - DIMENSIONS AND TOLERANCES COMPLY WITH TIA-1096 STANDARD.
 - CONNECTOR LUBRICANT APPLIED TO CONTACTS WITH FORWARD FACING GEOMETRY.

50 MICRO-INCHES [1.27um]	SS-7388H11S-NF-50
CONTACT PLATING IN MATING AREA	PART NUMBER

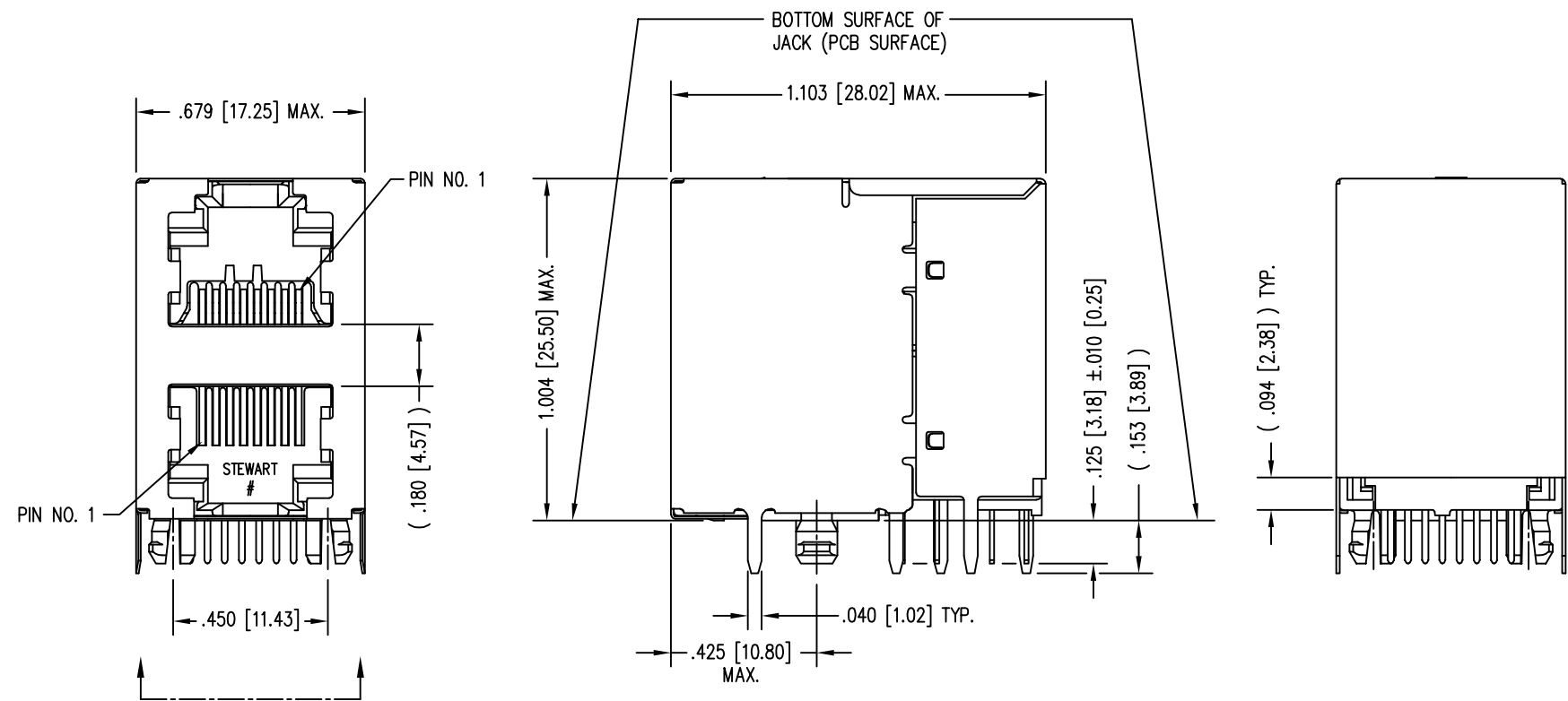
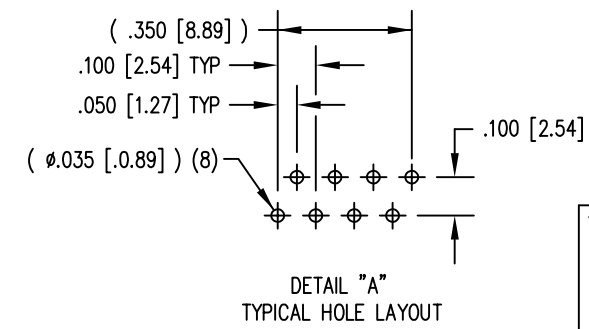
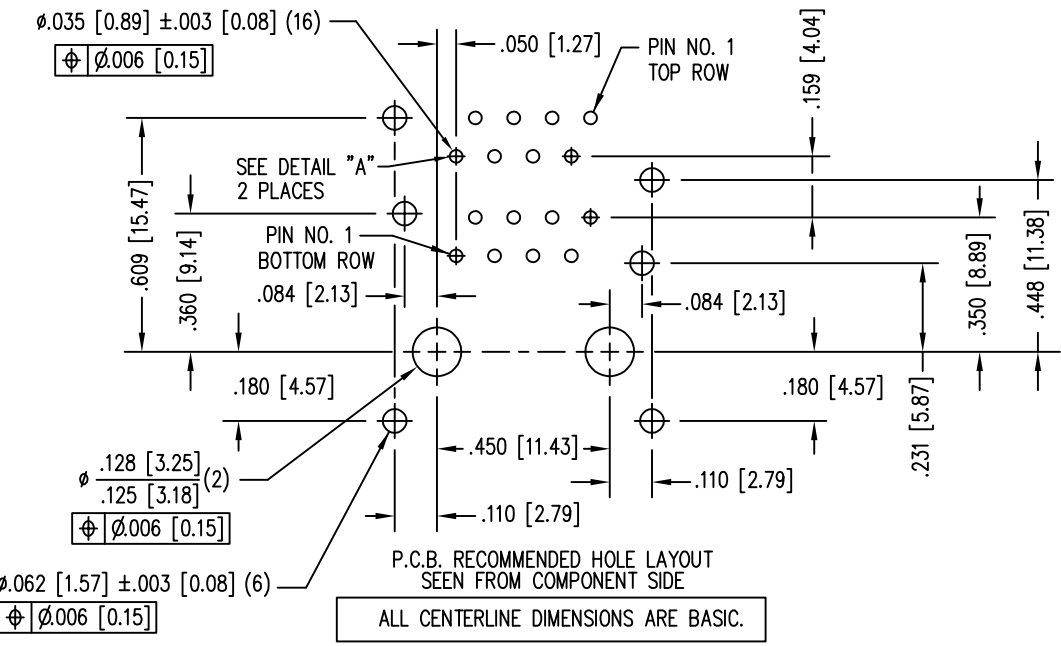

THIRD ANGLE PROJECTION	 11118 Susquehanna Trail South Glen Rock, PA 17327-9199 (717) 235-7512 http://www.stewartconnector.com
DO NOT SCALE DRAWING DRAWING IS SUBJECT TO CHANGE WITHOUT NOTICE	
DIMENSIONS: INCHES [METRIC]	TITLE: EIGHT CONTACT, EIGHT POSITION SHIELDED STACKED HARMONICA JACK, 2 PORTS (1 ON 1)
UNLESS OTHERWISE SPECIFIED TOLERANCES ARE ±.005 [0.13] ANGLES ARE ± 1°	DRN BY: KRL DATE: 4/11/06
SHEET NO. 1 OF 1	APPD BY: TRM DATE: 5-23-06
	DWG NO. CT730130 REV. A8