

## AN-1922 LM48511 Evaluation Board

### 1 Introduction

To help the user investigate and evaluate the LM48511SQ performance and capabilities, a fully populated demonstration board was created. This board is shown in Figure 1. Connected to an external power supply ( $3.0V \leq V_{DD} \leq 5.5V$ ) and a signal source, the LM48511SQ demonstration board easily exercises the amplifier's features.

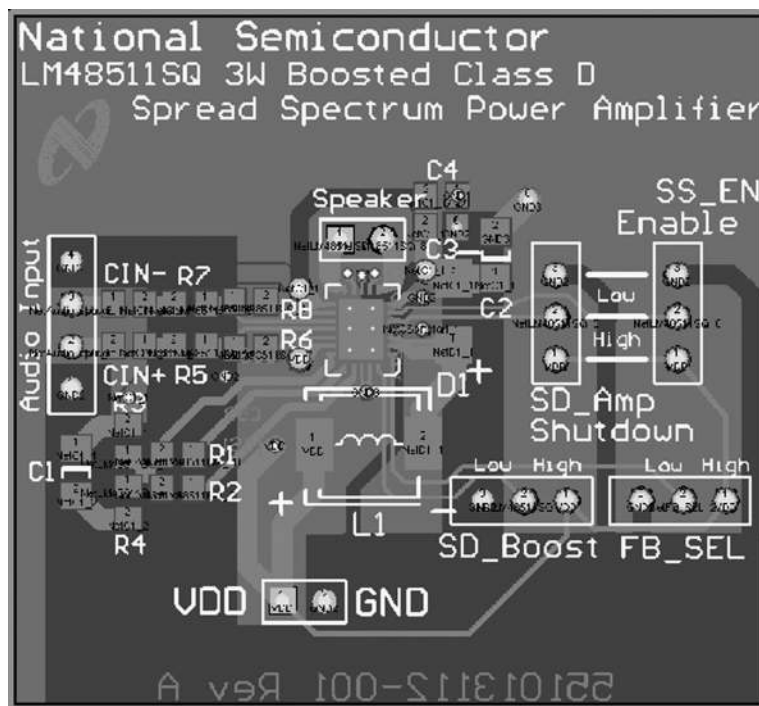

**Figure 1. Typical LM48511SQ Demonstration Board**

### 2 Quick Start Guide

- Step 1.** Apply a 3.0V to 5.5V power supply voltage to the VDD pin with respect to the ground (GND) pin.
- Step 2.** Set connectors SD\_Amp, SS\_En Enable, SD\_Boost to High. Set FB\_SEL to Low which boosts the regulator output voltage PV1 to about 7.6V.
- Step 3.** Apply a mono differential input signal into the Audio Input's two center pins of the 4-pin connector.
- Step 4.** Apply power. Make measurements.

### 3 General Description

The Texas Instruments LM48511 integrates a boost converter with a high efficiency Class D audio power amplifier to provide 3W continuous power into an 8Ω speaker when operating from a 5V power supply. When operating from a 3V to 4V power supply, the LM48511 can be configured to drive 1 to 2.5W into an 8Ω load with less than 1% distortion (THD+N). The Class D amplifier features a low noise PWM architecture that eliminates the output filter, reducing external component count, board area consumption, system cost, and simplifying design. A selectable spread spectrum modulation scheme suppresses RF emissions, further reducing the need for output filters. The LM48511's switching regulator is a current-mode boost converter operating at a fixed frequency of 1MHz. Two selectable feedback networks allow the LM48511 regulator to dynamically switch between two different output voltages, improving efficiency by optimizing the amplifier's supply voltage based on battery voltage and output power requirements. The LM48511 is designed for use in portable devices, such as GPS, mobile phones, and MP3 players. The high, 80% efficiency at 5V, extends battery life when compared to boosted Class AB amplifiers. Independent regulator and amplifier shutdown controls optimize power savings by disabling the regulator when high output power is not required.

The gain of the LM48511 is set by external resistors, which allows independent gain control from multiple sources by summing the signals. Output short circuit and thermal overload protection prevent the device from damage during fault conditions. Superior click and pop suppression eliminates audible transients during power-up and shutdown.

### 4 Board Features

The LM48511SQ 3W, Ultra-Low EMI, Filterless, Mono, Class D Audio Power Amplifier with Spread Spectrum demonstration board has all of the necessary connections using 0.100" headers connectors to apply the power supply voltage, audio input signals, and audio output (speaker). The amplified audio signal is only available on the audio output header.

### 5 Operating Conditions

Temperature Range: $T_{MIN} \leq T_A \leq T_{MAX}$	$-40^{\circ}\text{C} \leq T_A \leq +85^{\circ}\text{C}$
Supply Voltage ( $V_{DD}$ )	$3.0\text{V} \leq V_{DD} \leq \pm 5.5\text{V}$
Amplifier Voltage ( $PV1, V1$ )	$4.8\text{V} \leq PV_1 \leq \pm 8.0\text{V}$

## 6 Application Circuit Schematic

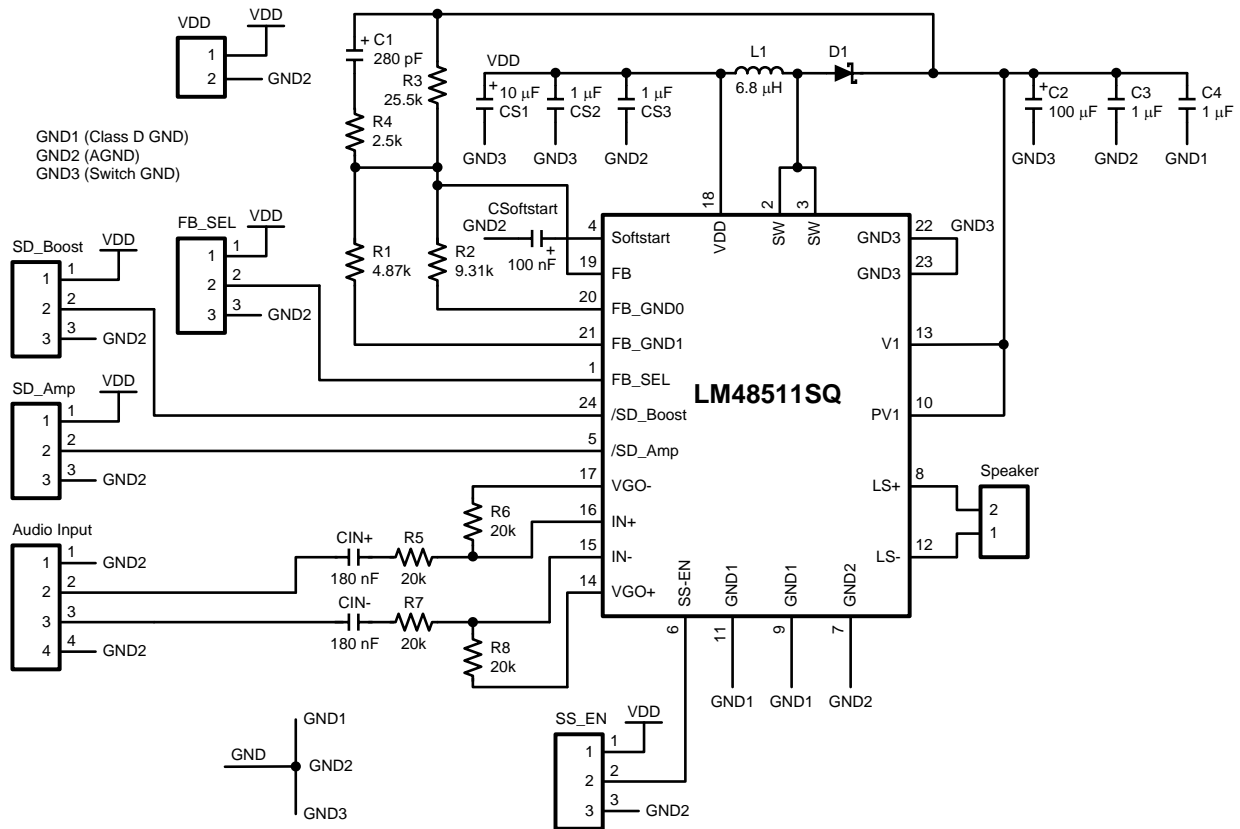

Figure 2. Typical LM48511 Audio Amplifier Application Circuit

## 7 Connections

Table 1. LM48511 Demonstration Board Connections

Designator	Function or Use
Supply Voltage (V <sub>DD</sub> )	The supply voltage operating range is from 3.0V to 5.5V, but the absolute maximum rating is 9V.
Audio Input	Connect a differential audio source to the two center pins of the Audio Input connector. For a single-ended audio source, connect one of the center pins to the adjacent center pin (GND) and connect the audio source to the remaining center pin.
Speaker (Audio Output)	Connect speaker load across the speaker connector.
SD_Amp	Set SD_AMP Low to disable the Class D amplifier. Set SD_AMP High to enable the Class D amplifier.
SS_EN Enable	Set SS_EN Low to enable Fixed frequency (FF) mode. Set SS_EN High to enable Spread Spectrum (SS) mode.
SD_Boost	Set SD_Boost Low to disable the boost regulator. Set SD_Boost High to enable the boost regulator.

**Table 1. LM48511 Demonstration Board Connections (continued)**

Designator	Function or Use
FB_SEL	Set the FB_SEL High for: $PV1 = V_{FB} \{1 + [25.5k\Omega / 4.87k\Omega]\}$ where $V_{FB} = 1.23V$
	Set the FB_SEL Low for: $PV1 = V_{FB} \{1 + [25.5k\Omega / 9.31k\Omega]\}$ where $V_{FB} = 1.23V$

## 8 Typical Performance Characteristics

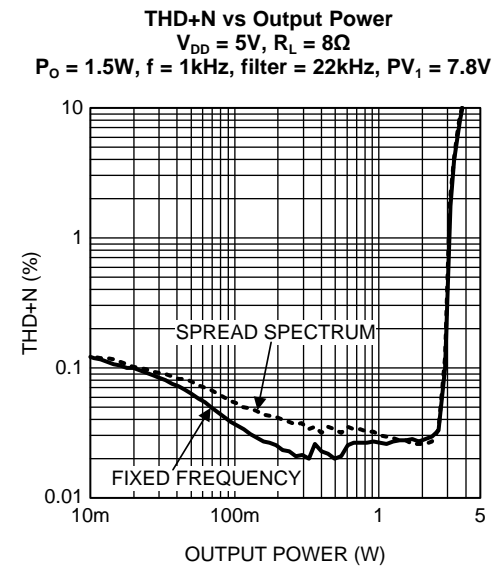
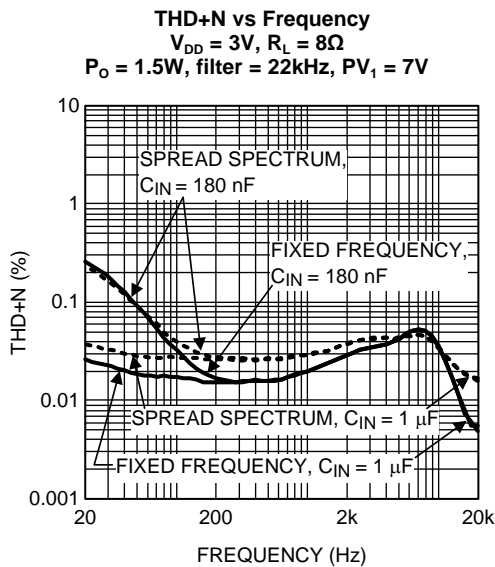
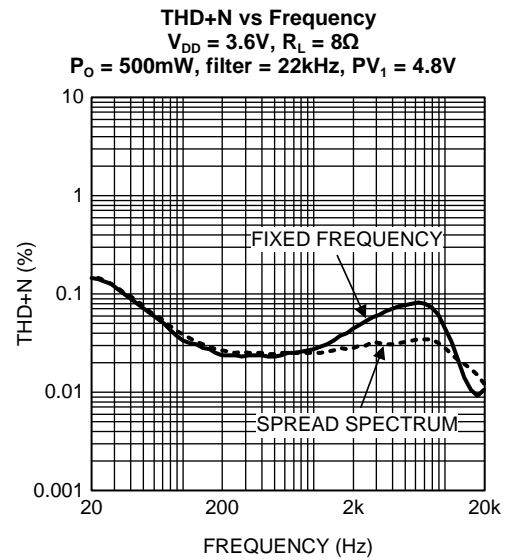
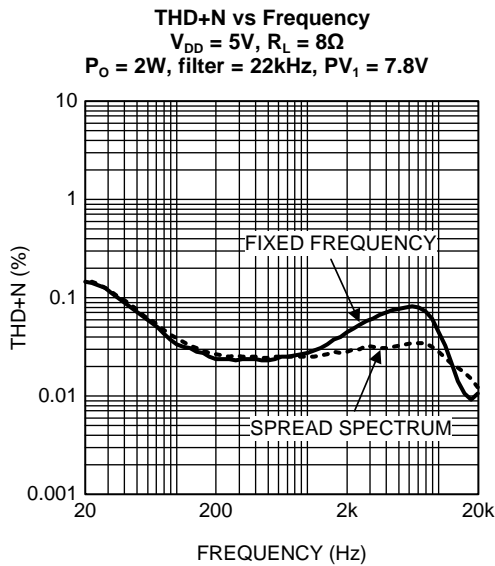

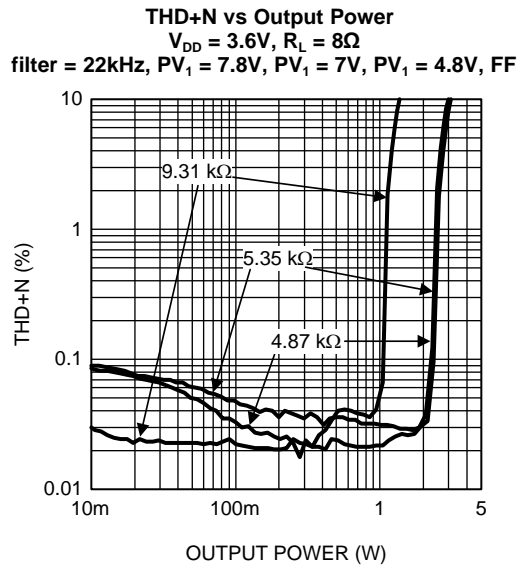
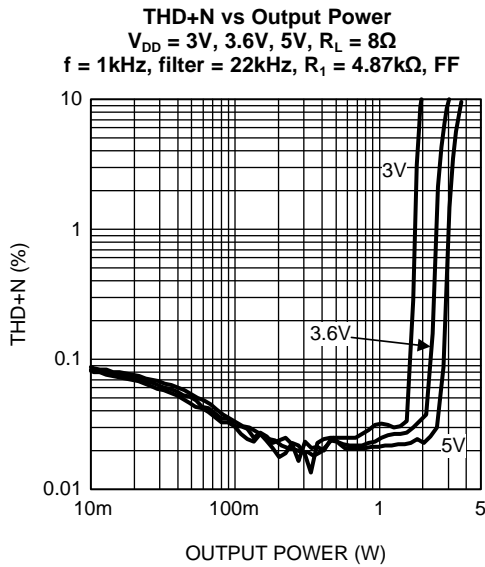
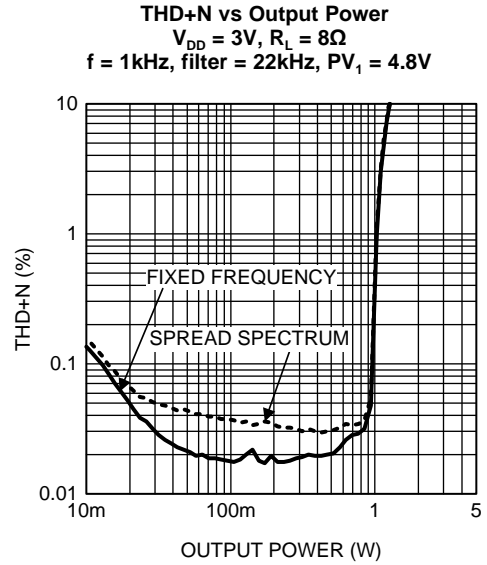
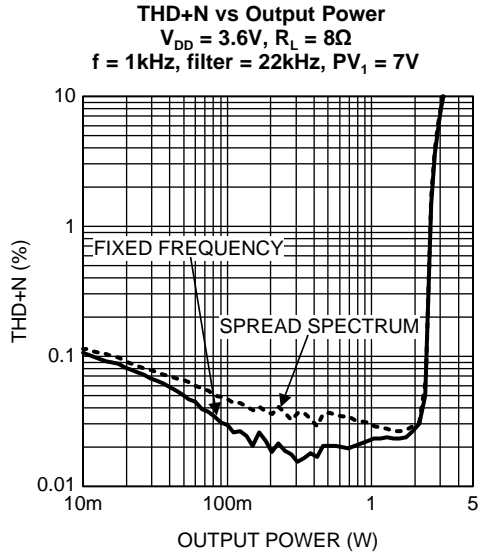

**Boost Amplifier vs Output Power**  
 $V_{DD} = 5V$ ,  $R_L = 8\Omega$   
 $f = 1kHz$ ,  $PV_1 = 7.8V$

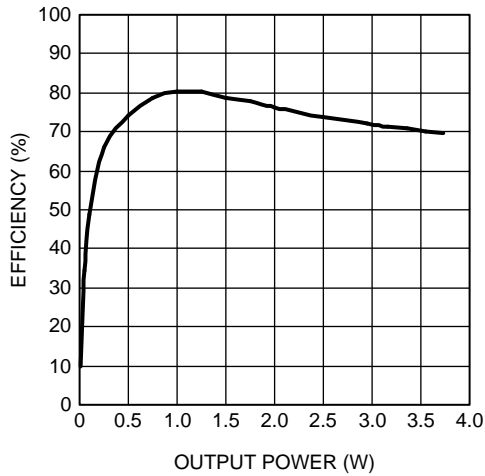

**Boost Amplifier vs Output Power**  
 $V_{DD} = 3.6V$ ,  $R_L = 8\Omega$   
 $f = 1kHz$ ,  $PV_1 = 7V$

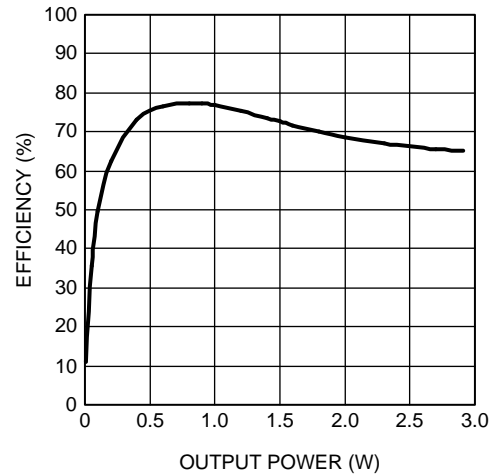

**Boost Amplifier vs Output Power**  
 $V_{DD} = 3V$ ,  $R_L = 8\Omega$   
 $f = 1kHz$ ,  $PV_1 = 4.8V$

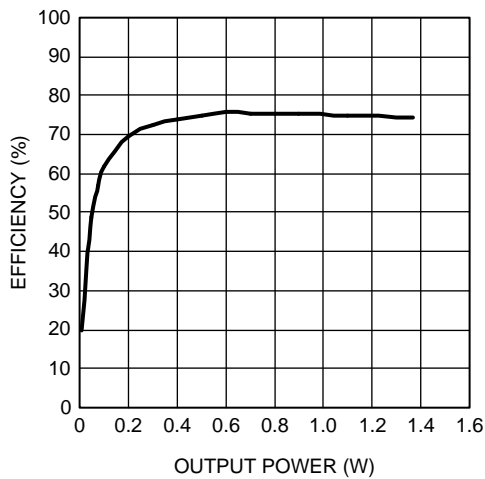

**PSRR vs Frequency**  
 $V_{DD} = 5V$ ,  $R_L = 8\Omega$   
 $V_{RIPPLE} = 200mV_{PP}$ ,  $PV_1 = 7.8V$

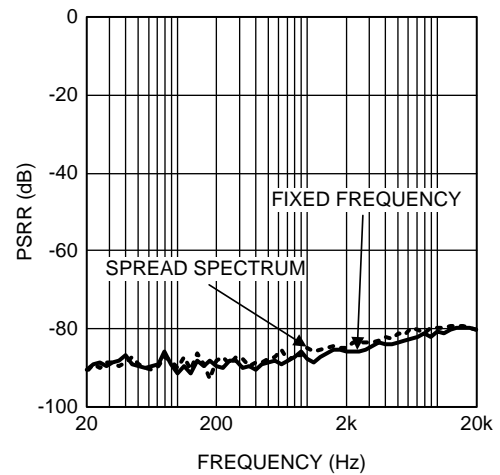

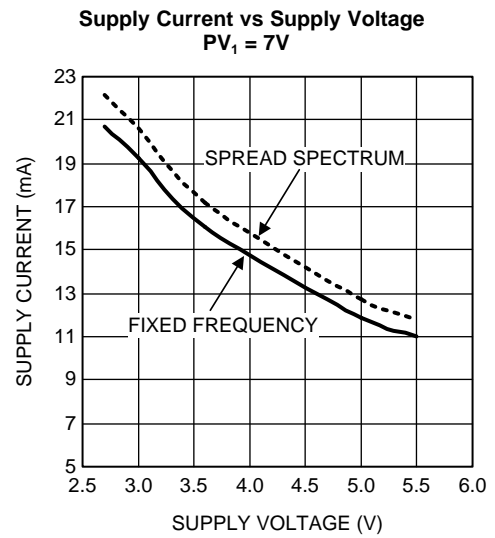
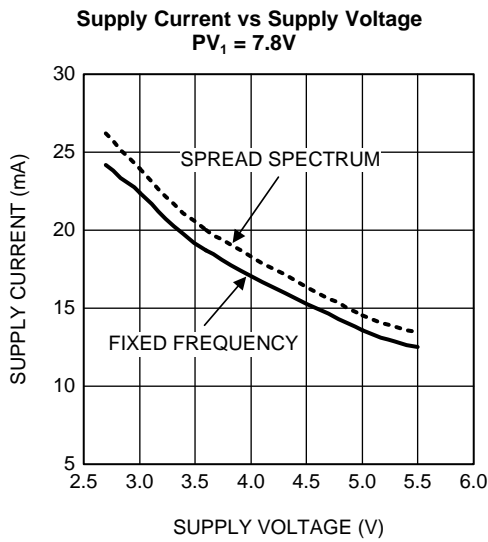
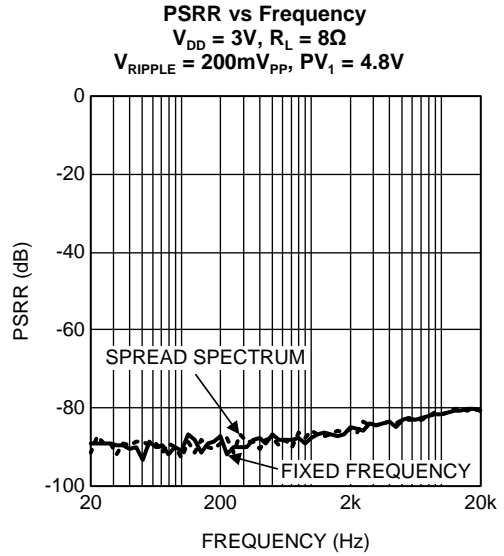
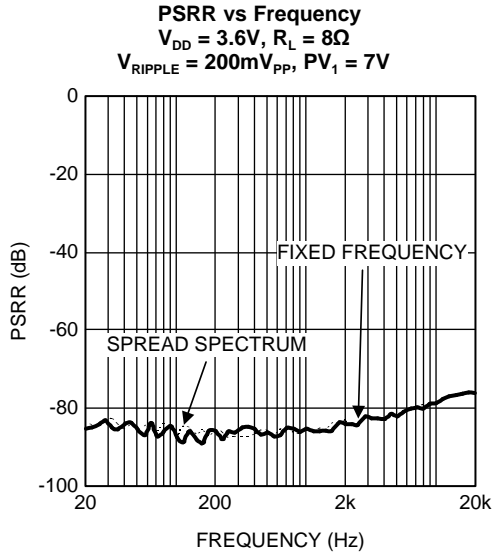

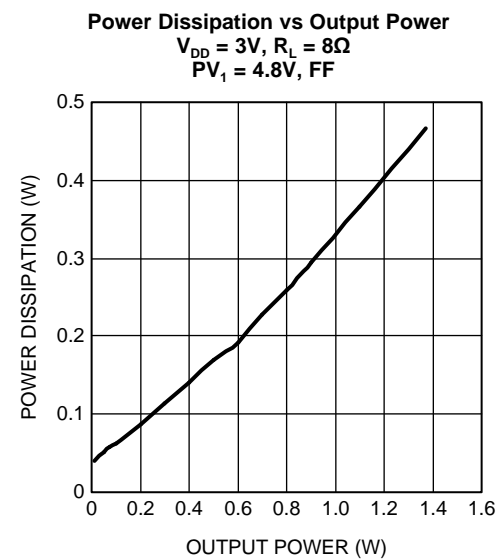
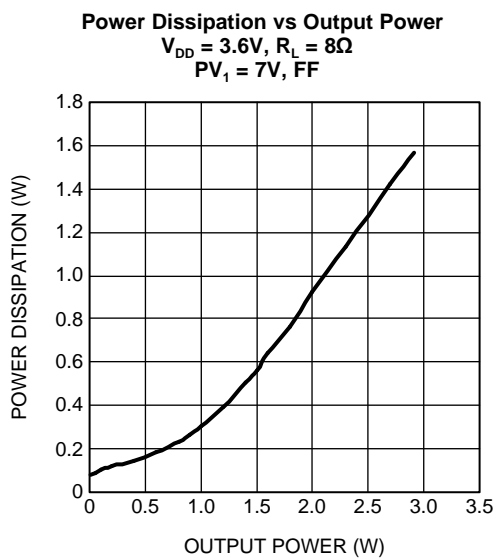
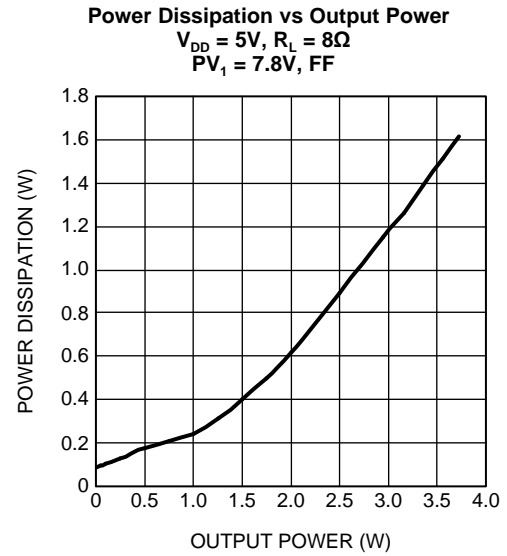
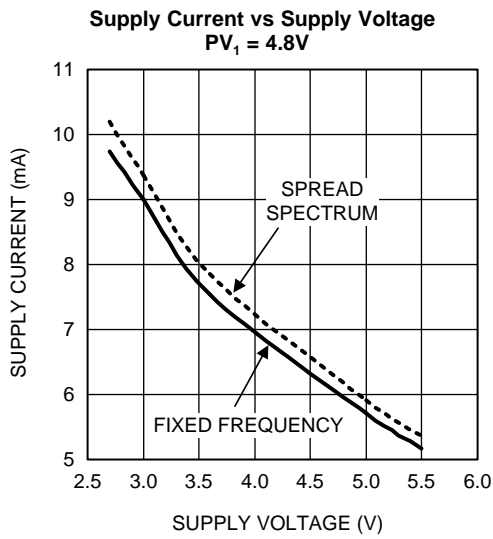



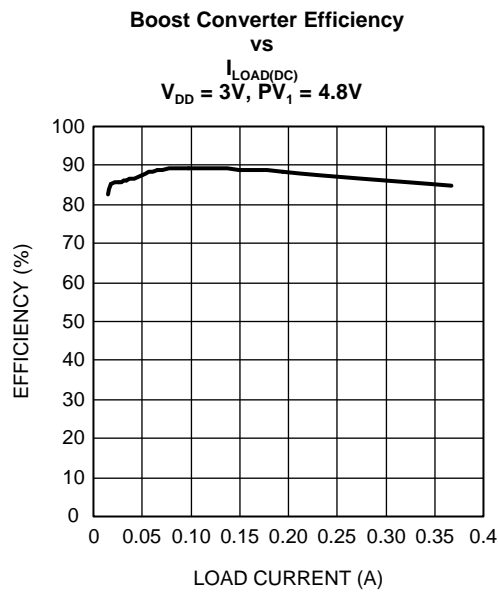
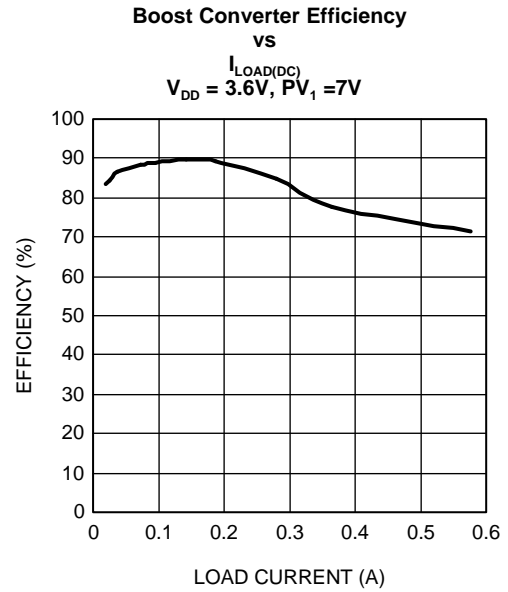
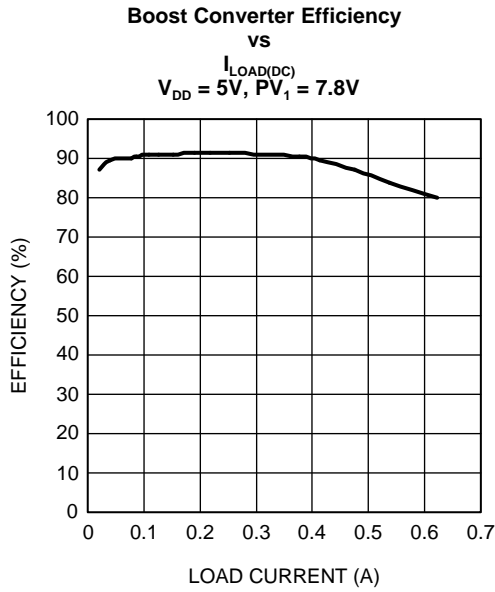

## 9 PCB Layout Guidelines

This section provides general practical guidelines for PCB layouts that use various power and ground traces. Designers should note that these are only “rule-of-thumb” recommendations and the actual results are predicated on the final layout.

### 9.1 Power and Ground Circuits

Star trace routing techniques can have a major positive impact on low-level signal performance. Star trace routing refers to using individual traces that radiate from a signal point to feed power and ground to each circuit or even device.

### 9.2 Layout Helpful Hints:

1. Avoid routing traces under the inductor.
2. Use three separate grounds that eventually connect to one point:
  - (a) Signal or quiet ground (GND2)
  - (b) Ground for the LM48511 device (GND1)
  - (c) SW (GND3) (switch ground). This trace for the switch ground carries the heaviest current (3A) and therefore is the noisiest. Make this trace as wide and short as possible and keep at a distance from the quiet ground and device ground. Give distance priority to the quiet ground.

## 10 Bill Of Materials

Designator	Description	Footprint	Qty	Value
Cf1	CHIP CAPACITOR GENERIC	CAP 0805	1	470pF
CINA	CHIP CAPACITOR GENERIC	CAP 1210	1	1 $\mu$ F
CINB	CHIP CAPACITOR GENERIC	CAP 1210	1	1 $\mu$ F
Co	CHIP CAPACITOR GENERIC	CAP 1210	1	10 $\mu$ F
Cs1	CHIP CAPACITOR GENERIC	CAP 1210	1	2.2 $\mu$ F
Cs2	CHIP CAPACITOR GENERIC	CAP 1210	1	4.7 $\mu$ F
D1	SCHOTTKY DIODE	DIODE MBR0520 IR	1	
L1		IND_COILCRAFT-DO1813P	1	4.7 $\mu$ H
R1	CHIP RESISTOR GENERIC	RES 0805	1	41.2K
R2	CHIP RESISTOR GENERIC	RES 0805	1	13.3K
RINA	CHIP RESISTOR GENERIC	RES 0805	1	150K
RINB	CHIP RESISTOR GENERIC	RES 0805	1	150K

## 11 Demonstration Board PCB Layout

[Figure 3](#) through [Figure 8](#) shows the different layers used to create the LM48511SQ demonstration board. [Figure 3](#) is the silkscreen that shows component locations on the board's top surface. [Figure 4](#) is the metal Top Layer. [Figure 5](#) is the metal Midlayer 1. [Figure 6](#) is the metal Midlayer 2. [Figure 7](#) is the metal Bottom Layer. [Figure 8](#) is the silkscreen that shows component locations on the board bottom.

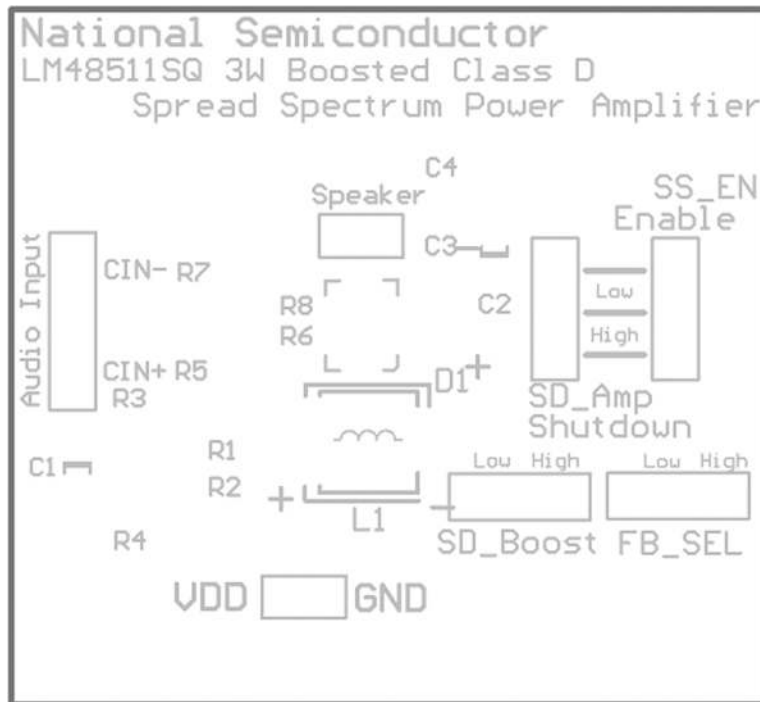

Figure 3. Top Silkscreen

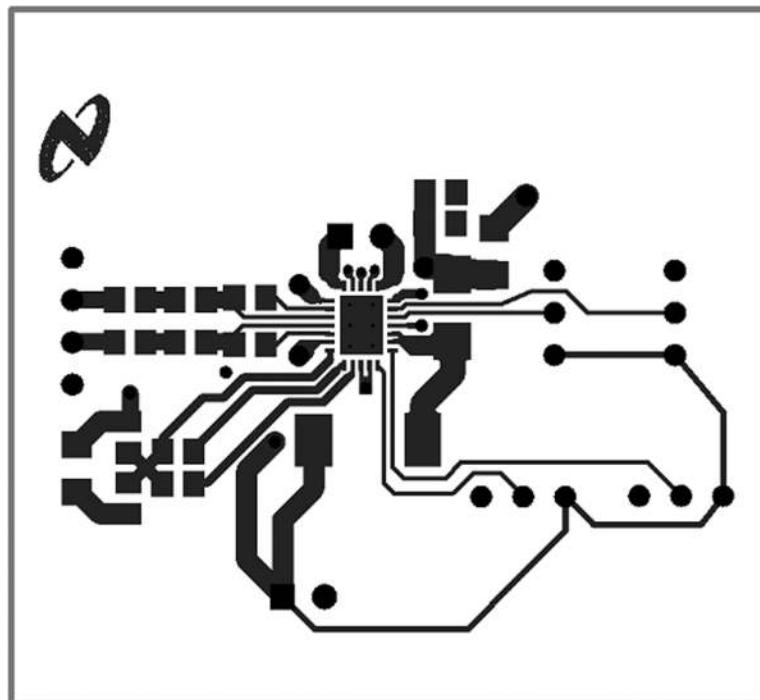

Figure 4. Top Layer

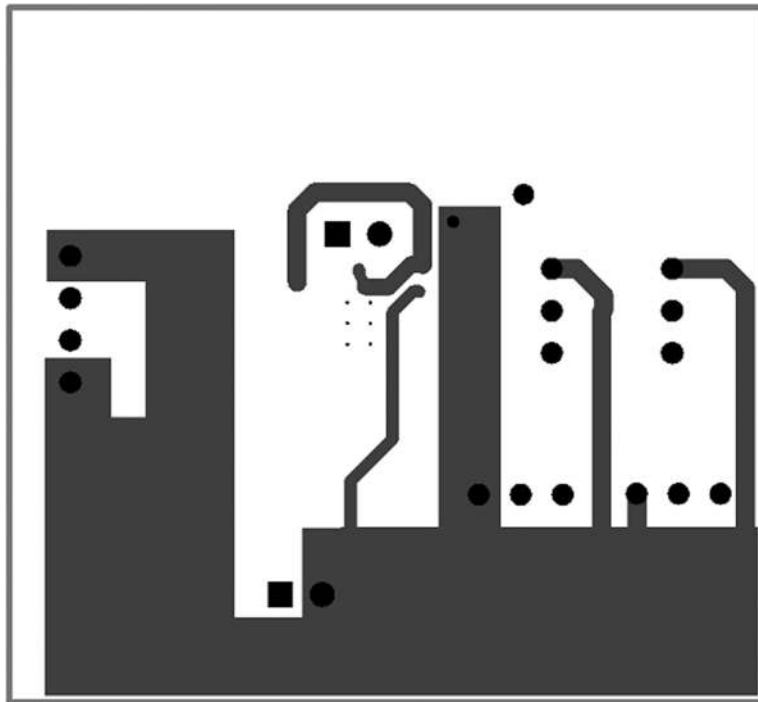

Figure 5. Mid Layer 1

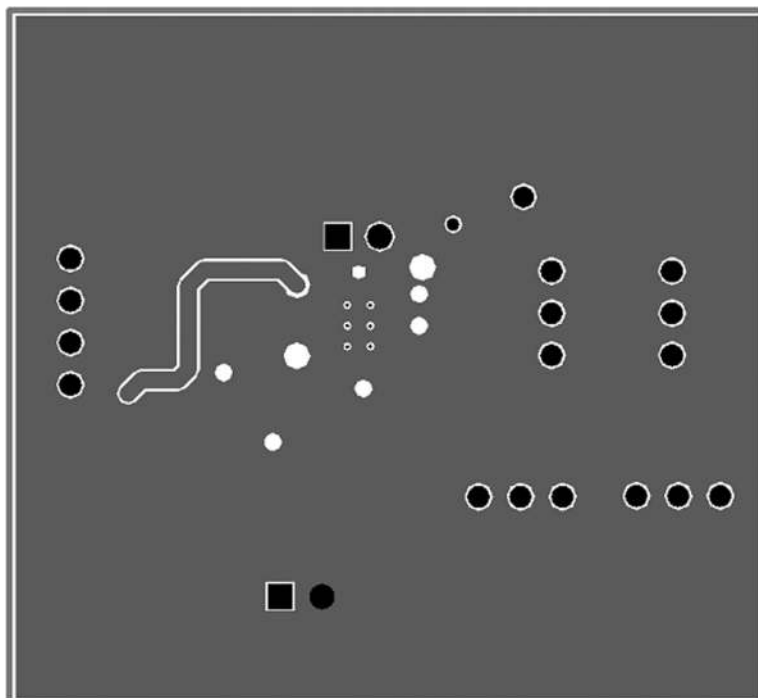

Figure 6. Mid Layer 2

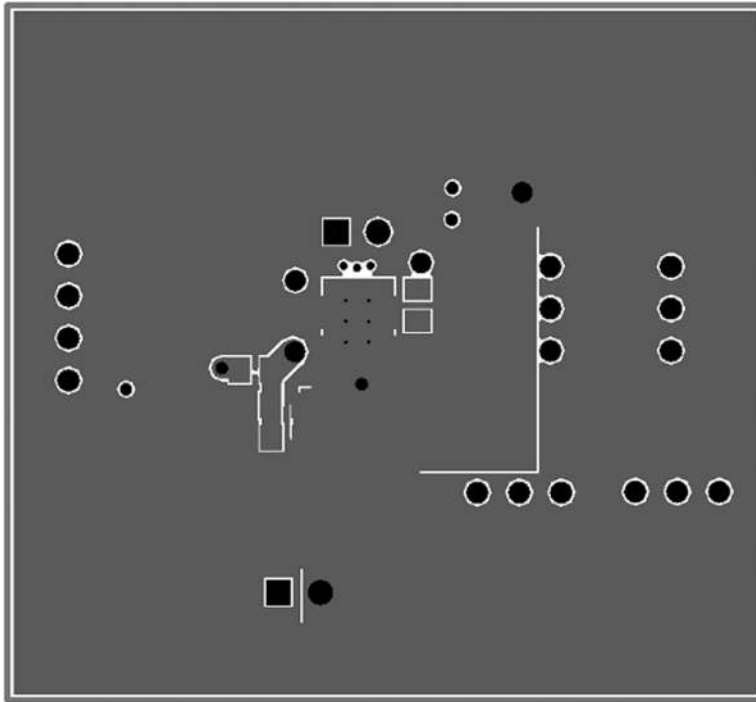

Figure 7. Bottom Layer

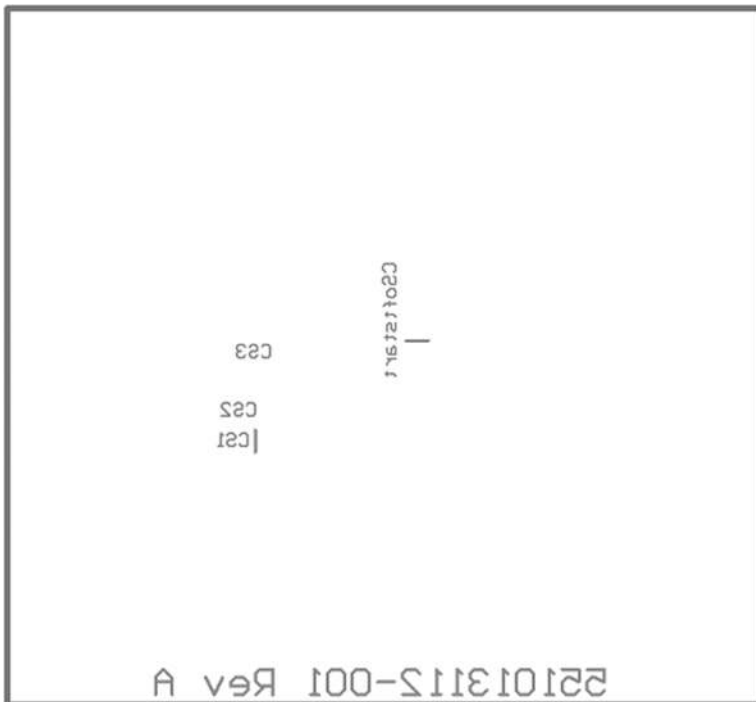

Figure 8. Bottom Overlay

## 12 Revision History

Rev	Date	Description
1.0	11/05/08	Initial release.
1.01	08/05/11	Changed the title of <a href="#">Table 1</a> from LME49600 to LM48511.
1.02	10/18/12	Edited <a href="#">Table 1</a> (Demonstration Board Connections). Edited <a href="#">Figure 2</a> (Typical LM48511 Audio Amplifier Circuit).

## IMPORTANT NOTICE

Texas Instruments Incorporated and its subsidiaries (TI) reserve the right to make corrections, enhancements, improvements and other changes to its semiconductor products and services per JESD46, latest issue, and to discontinue any product or service per JESD48, latest issue. Buyers should obtain the latest relevant information before placing orders and should verify that such information is current and complete. All semiconductor products (also referred to herein as "components") are sold subject to TI's terms and conditions of sale supplied at the time of order acknowledgment.

TI warrants performance of its components to the specifications applicable at the time of sale, in accordance with the warranty in TI's terms and conditions of sale of semiconductor products. Testing and other quality control techniques are used to the extent TI deems necessary to support this warranty. Except where mandated by applicable law, testing of all parameters of each component is not necessarily performed.

TI assumes no liability for applications assistance or the design of Buyers' products. Buyers are responsible for their products and applications using TI components. To minimize the risks associated with Buyers' products and applications, Buyers should provide adequate design and operating safeguards.

TI does not warrant or represent that any license, either express or implied, is granted under any patent right, copyright, mask work right, or other intellectual property right relating to any combination, machine, or process in which TI components or services are used. Information published by TI regarding third-party products or services does not constitute a license to use such products or services or a warranty or endorsement thereof. Use of such information may require a license from a third party under the patents or other intellectual property of the third party, or a license from TI under the patents or other intellectual property of TI.

Reproduction of significant portions of TI information in TI data books or data sheets is permissible only if reproduction is without alteration and is accompanied by all associated warranties, conditions, limitations, and notices. TI is not responsible or liable for such altered documentation. Information of third parties may be subject to additional restrictions.

Resale of TI components or services with statements different from or beyond the parameters stated by TI for that component or service voids all express and any implied warranties for the associated TI component or service and is an unfair and deceptive business practice. TI is not responsible or liable for any such statements.

Buyer acknowledges and agrees that it is solely responsible for compliance with all legal, regulatory and safety-related requirements concerning its products, and any use of TI components in its applications, notwithstanding any applications-related information or support that may be provided by TI. Buyer represents and agrees that it has all the necessary expertise to create and implement safeguards which anticipate dangerous consequences of failures, monitor failures and their consequences, lessen the likelihood of failures that might cause harm and take appropriate remedial actions. Buyer will fully indemnify TI and its representatives against any damages arising out of the use of any TI components in safety-critical applications.

In some cases, TI components may be promoted specifically to facilitate safety-related applications. With such components, TI's goal is to help enable customers to design and create their own end-product solutions that meet applicable functional safety standards and requirements. Nonetheless, such components are subject to these terms.

No TI components are authorized for use in FDA Class III (or similar life-critical medical equipment) unless authorized officers of the parties have executed a special agreement specifically governing such use.

Only those TI components which TI has specifically designated as military grade or "enhanced plastic" are designed and intended for use in military/aerospace applications or environments. Buyer acknowledges and agrees that any military or aerospace use of TI components which have **not** been so designated is solely at the Buyer's risk, and that Buyer is solely responsible for compliance with all legal and regulatory requirements in connection with such use.

TI has specifically designated certain components as meeting ISO/TS16949 requirements, mainly for automotive use. In any case of use of non-designated products, TI will not be responsible for any failure to meet ISO/TS16949.

### Products

Audio	<a href="http://www.ti.com/audio">www.ti.com/audio</a>
Amplifiers	<a href="http://amplifier.ti.com">amplifier.ti.com</a>
Data Converters	<a href="http://dataconverter.ti.com">dataconverter.ti.com</a>
DLP® Products	<a href="http://www.dlp.com">www.dlp.com</a>
DSP	<a href="http://dsp.ti.com">dsp.ti.com</a>
Clocks and Timers	<a href="http://www.ti.com/clocks">www.ti.com/clocks</a>
Interface	<a href="http://interface.ti.com">interface.ti.com</a>
Logic	<a href="http://logic.ti.com">logic.ti.com</a>
Power Mgmt	<a href="http://power.ti.com">power.ti.com</a>
Microcontrollers	<a href="http://microcontroller.ti.com">microcontroller.ti.com</a>
RFID	<a href="http://www.ti-rfid.com">www.ti-rfid.com</a>
OMAP Applications Processors	<a href="http://www.ti.com/omap">www.ti.com/omap</a>
Wireless Connectivity	<a href="http://www.ti.com/wirelessconnectivity">www.ti.com/wirelessconnectivity</a>

### Applications

Automotive and Transportation	<a href="http://www.ti.com/automotive">www.ti.com/automotive</a>
Communications and Telecom	<a href="http://www.ti.com/communications">www.ti.com/communications</a>
Computers and Peripherals	<a href="http://www.ti.com/computers">www.ti.com/computers</a>
Consumer Electronics	<a href="http://www.ti.com/consumer-apps">www.ti.com/consumer-apps</a>
Energy and Lighting	<a href="http://www.ti.com/energy">www.ti.com/energy</a>
Industrial	<a href="http://www.ti.com/industrial">www.ti.com/industrial</a>
Medical	<a href="http://www.ti.com/medical">www.ti.com/medical</a>
Security	<a href="http://www.ti.com/security">www.ti.com/security</a>
Space, Avionics and Defense	<a href="http://www.ti.com/space-avionics-defense">www.ti.com/space-avionics-defense</a>
Video and Imaging	<a href="http://www.ti.com/video">www.ti.com/video</a>

### TI E2E Community

[e2e.ti.com](http://e2e.ti.com)