

THIS COPY IS PROVIDED ON A RESTRICTED BASIS AND IS NOT TO BE USED IN ANY WAY DETRIMENTAL TO THE INTERESTS OF PANDUIT CORP.

NOTES:

1. SEE CURRENT CATALOG FOR PART NUMBER SUFFIXES TO INDICATE COLOR AND/OR PACKAGE QUANTITIES.
2. SEE CATALOG FOR A COMPLETE LIST OF PARTS APPLICABLE FOR USE WITH THIS PRODUCT.
3. REFERENCE TIA-568-C.0. FOR DETAILS ON METHOD A CONNECTIVITY.
4. MATERIALS:
  - A. BOX AND LID: ALUMINUM
  - B. ADAPTERS: COMPOSITE PLASTIC
5. CASSETTE MODULE WEIGHT: 33.1oz [940.4gr]
6. DIMENSIONS IN BRACKETS ARE METRIC
7. ALL MATERIALS AND COMPONENTS USED MEET THE MATERIAL RESTRICTIONS OF RoHS, (EUROPEAN DIRECTIVE 2011/65/EC ON THE RESTRICTIONS OF HAZARDOUS SUBSTANCES) AS PROPOSED BY THE RoHS TECHNICAL ADAPTATION COMMITTEE.

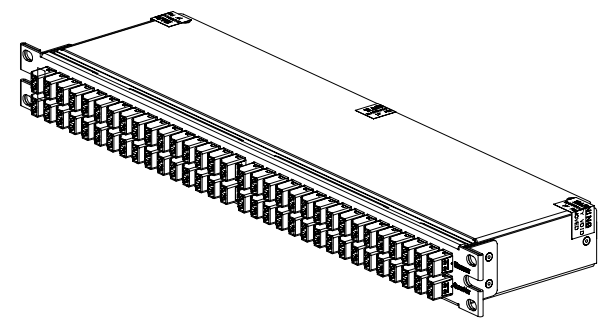
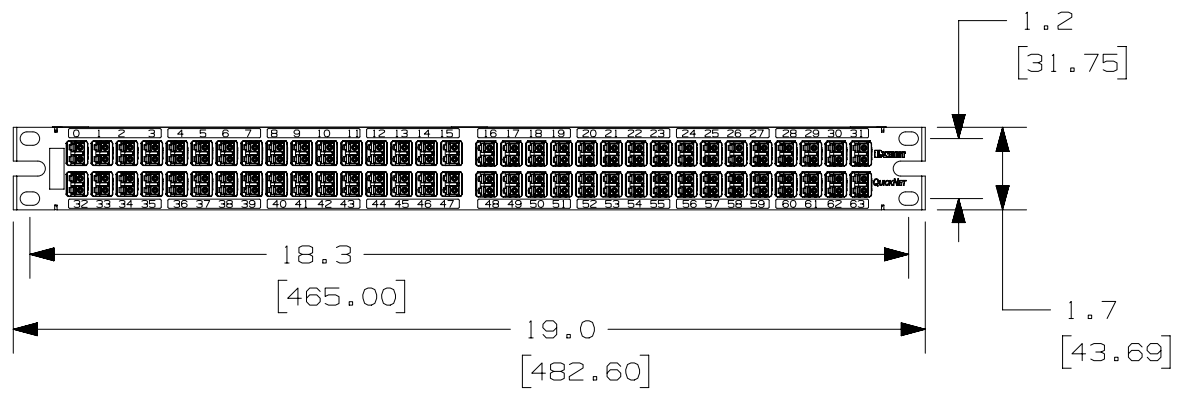
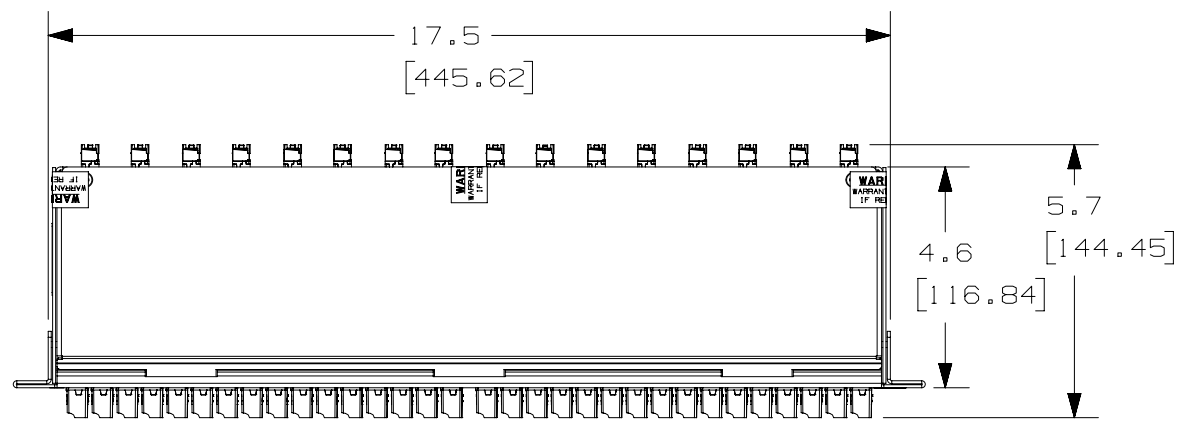

ISOMETRIC VIEW

						TITLE HDQ SERIES FIBER OPTIC FLAT CASSETTES FOR BROCADE FC16-64 PORT BLADE (128 FIBERS)						
						CUSTOMER DRAWING						
						ITEM REVISION NAME 12F193AK/00				<b>PANDUIT</b>		
						DATASET FILE NAME 12F193AK_DC/00A						
						UNLESS OTHERWISE SPECIFIED, DIMENSIONAL TOLERANCES ARE: IN (mm) .x ± .xxx ± .010 (0.3) .xx ± .03 (0.8) ANGLES ±				MATERIAL:		
00 07-06-16 SAT DWW EJH RELEASED TO PRODUCTION						12F193AK-DC				DRAWING NUMBER: 12F193AK-DC		
REV	DATE	BY	CHK	APR	DESCRIPTION	ECN	DRAWN BY SAT	DATE 06-10-16	CHK DWW	SCALE NONE	SHT 1 OF 3	SIZE A

TABLE 1 - HDQ SERIES FIBER OPTIC CASSETTE - MPO TO LC 10 GbE  
1RU FLAT PROFILE; 128-FIBER BROCADE LABELING

PART NUMBER	DESCRIPTION
METHOD A	
F1RBXA-2B08-10S	OM3 ULTRA FIBER; 8-FIBER MPO TO DUPLEX LC
F1RBXO-2B08-10S	OM3 OPTIMIZED FIBER; 8-FIBER MPO TO DUPLEX LC
F1RBZA-2B08-10S	OM4 ULTRA FIBER; 8-FIBER MPO TO DUPLEX LC
F1RBZO-2B08-10S	OM4 OPTIMIZED FIBER; 8-FIBER MPO TO DUPLEX LC

REV	DATE	BY	CHK	APR	DESCRIPTION	ECN	DRAWN BY	DATE	CHK	SCALE	SHT 2 OF 3	SIZE
00	07-06-16	SAT	DWW	EJH	RELEASED TO PRODUCTION	12F193AK-DC	SAT	06-10-16	DWW	NONE		A

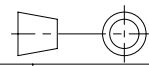
TITLE HDQ SERIES FIBER OPTIC FLAT CASSETTES FOR BROCADE FC16-64 PORT BLADE (128 FIBERS)		
CUSTOMER DRAWING		
ITEM REVISION NAME 12F193AK/00	MATERIAL:	
DATASET FILE NAME 12F193AK_DC/00A		
UNLESS OTHERWISE SPECIFIED, DIMENSIONAL TOLERANCES ARE: IN (mm)		DRAWING NUMBER: 12F193AK-DC
.x ± .xxx ± .010 (0.3)		
.xx ± .03 (0.8) ANGLES ±		
		
THIRD ANGLE PROJECTION		

2

1

2

1

THIS COPY IS PROVIDED ON A RESTRICTED BASIS AND IS NOT TO BE USED IN ANY WAY DETRIMENTAL TO THE INTERESTS OF PANDUIT CORP.

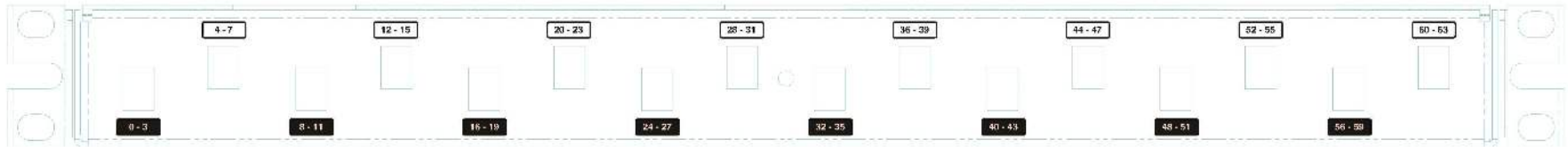
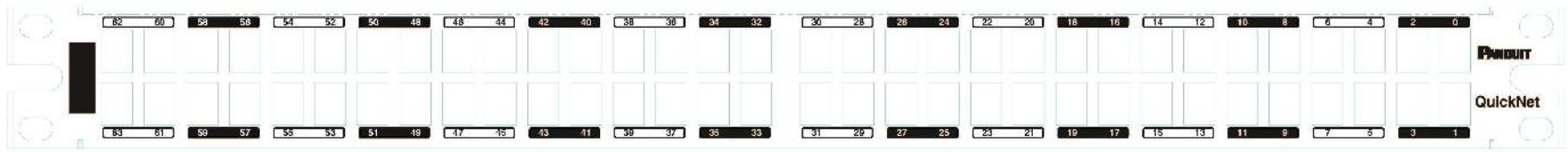

00	07-06-16	SAT	DWW	EJH	RELEASED TO PRODUCTION	12F193AK-DC
REV	DATE	BY	CHK	APR	DESCRIPTION	ECN

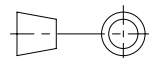
TITLE		HDQ SERIES FIBER OPTIC FLAT CASSETTES FOR BROCADE FC16-64 PORT BLADE (128 FIBERS)		
		CUSTOMER DRAWING		
ITEM REVISION NAME		12F193AK/00		
DATASET FILE NAME		12F193AK_DC/00A		
UNLESS OTHERWISE SPECIFIED, DIMENSIONAL TOLERANCES ARE: IN (mm)		 MATERIAL:  DRAWING NUMBER: 12F193AK-DC		
.X ± .XXX ± .010 (0.3) .XX ± .03 (0.8)      ANGLES ±				
 THIRD ANGLE PROJECTION				
DRAWN BY	DATE	CHK	SCALE	SIZE
SAT	06-10-16	DWW	NONE	SHT 3 OF 3 A