

Power TOPLED® with Lens Enhanced optical Power LED (HOP2000)

LS E63B, LA E63B, LO E63B, LY E63B



Vorläufige Daten / Preliminary Data

Besondere Merkmale

- **Gehäusetyp:** weißes P-LCC-4-Gehäuse
- **Besonderheit des Bauteils:** fokussierte Abstrahlung in SMT-Technologie; hohe Helligkeit in Achsrichtung
- **Wellenlänge:** 633 nm (super-rot), 617 nm (amber), 606 nm (orange), 587 nm (gelb)
- **Abstrahlwinkel:** 30°
- **Technologie:** InGaAlP
- **optischer Wirkungsgrad:** 24 lm/W (amber, orange, gelb), 18 lm/W (super-rot)
- **Gruppierungsparameter:** Lichtstärke, Durchflussspannung, Wellenlänge
- **Verarbeitungsmethode:** für alle SMT-Bestücktechniken geeignet
- **Lötmethode:** IR Reflow Löten und Wellenlöten (TTW)
- **Vorbehandlung:** nach JEDEC Level 2
- **Gurtung:** 12-mm Gurt mit 2000/Rolle, ø330 mm
- **ESD-Festigkeit:** ESD-sicher bis 2 kV nach EOS/ESD-5.1-1993

Anwendungen

- Ampelanwendung
- Hinterleuchtung (LCD, Schalter, Tasten, Displays, Werbebeleuchtung)
- Innen- und Außenbeleuchtung im Automobilbereich (z.B. Instrumentenbeleuchtung, Blinker, Bremslichter, seittl. Begrenzungsleuchten)
- Ersatz von Kleinst-Glühlampen
- Markierungsbeleuchtung (z.B. Stufen, Fluchtwege, u.ä.)
- Signal- und Symbolleuchten

Features

- **package:** white P-LCC-4 package
- **feature of the device:** focussed radiation in SMT technology; high brightness in beam direction
- **wavelength:** 633 nm (super-red), 617 nm (amber), 606 nm (orange), 587 nm (yellow)
- **viewing angle:** 30°
- **technology:** InGaAlP
- **optical efficiency:** 24 lm/W (amber, orange, yellow), 18 lm/W (super-red)
- **grouping parameter:** luminous intensity, forward voltage, wavelength
- **assembly methods:** suitable for all SMT assembly methods
- **soldering methods:** IR reflow soldering and TTW soldering
- **preconditioning:** acc. to JEDEC Level 2
- **taping:** 12-mm tape with 2000/reel, ø330 mm
- **ESD-withstand voltage:** up to 2 kV acc. to EOS/ESD-5.1-1993

Applications

- traffic lights
- backlighting (LCD, switches, keys, displays, illuminated advertising)
- interior and exterior automotive lighting (e.g. dashboard backlighting, turn signal lamps, brake lights, sidemarkers)
- substitution of micro incandescent lamps
- marker lights (e.g. steps, exit ways, etc.)
- signal and symbol luminaire

Typ	Emissionsfarbe	Farbe der Lichtaustrittsfläche	Partieller Lichtfluss	Lichtstrom	Bestellnummer
Type	Color of Emission	Color of the Light Emitting Area	Partial Flux $I_F = 50 \text{ mA}$ $E_V [\text{lux}]$	Luminous Flux $I_F = 50 \text{ mA}$ $\Phi_V [\text{lm}]$	Ordering Code
LS E63B-BBCB-1-1	super-red	colorless clear	2240 ...4500	1900 (typ.)	Q65110A0676
LA E63B-CBEA-24-1	amber	colorless clear	3550 ... 9000	2900 (typ.)	Q65110A0119
LO E63B-CBEA-24-1	orange	colorless clear	3550 ... 9000	2900 (typ.)	Q65110A0773
LY E63B-CBEA-26-1	yellow	colorless clear	3550 ... 9000	2900 (typ.)	Q65110A0091

Anm.: -1-1 gesamter Farbbereich (siehe **Seite 4**)
 -24-1 gesamter Farbbereich, Lieferung in Einzelgruppen (siehe **Seite 5**)
 -26-1 gesamter Farbbereich, Lieferung in Einzelgruppen (siehe **Seite 5**)
 -24-1 gesamter Durchlassspannungsbereich, Lieferung in Einzelgruppen (siehe **Seite 5**)
 -26-1 gesamter Durchlassspannungsbereich, Lieferung in Einzelgruppen (siehe **Seite 5**)

Die Standardlieferform von Serientypen beinhaltet eine Familiengruppe, die aus nur 4 Halbgruppen besteht. Einzelne Halbgruppen sind nicht erhältlich.
 In einer Verpackungseinheit / Gurt ist immer nur eine Halbgruppe enthalten.

Da die Gruppierung der LEDs in Lux mit der innovativem Partial Flux methode erfolgt, wurden Vergleichsmessungen an Bauteilen jeweils mit dem "Partial Flux" Testkopf und dem "Standard LED" Testkopf (gemäß CIE-127-B) durchgeführt. Der Vergleich soll als Orientierung dienen, er stellt keine eins zu eins Korrelation dar. Ziel dieses Vergleichs ist ein besseres Verständnis des Lichtflusses in [lux] in Relation zu den Lichtstärkewerten in [cd]. Das Verhältnis von typischen Werten die mit dem "Partial Flux" gemessen werden zu denen, die mit dem standard Messkopf gemessenen ist $[\text{lux}] \times 0.94 = [\text{cd}]$.

Dimmverhältnis im Gleichstrom-Betrieb max. 5:1

Note: -1-1 Total color tolerance range (please see **page 4**)
 -24-1 Total color tolerance range, delivery in single groups (please see **page 5**)
 -26-1 Total color tolerance range, delivery in single groups (please see **page 5**)
 -24-1 Total forward voltage tolerance, delivery in single groups (see **page 5**)
 -26-1 Total forward voltage tolerance, delivery in single groups (see **page 5**)

The standard shipping format for serial types includes a group of only 4 individual groups. Individual half groups are not available.
 No packing unit / tape ever contains more than one luminous intensity half group.

As the grouping of LED in lux is made with the innovative partial flux methode ,some measurement to compare the results tested with "Partial Flux" Testhead compared to "standard LED" Testhead (in compliance with CIE-127-B) were made. The comparison should be used for a better understanding of partial flux in [lux] in relation to the values stated in luminous intensity [cd]. It should not be taken as one to one correlation. Comparison of typical values measured with "Partial Flux" and normal LED Testhead are $[\text{lux}] \times 0.94 = [\text{cd}]$.

Dimming range for direct current mode max. 5:1

Grenzwerte
Maximum Ratings

Bezeichnung Parameter	Symbol Symbol	Wert Value	Einheit Unit
Betriebstemperatur Operating temperature range	T_{op}	- 40 ... + 100	°C
Lagertemperatur Storage temperature range	T_{stg}	- 40 ... + 100	°C
Sperrschichttemperatur Junction temperature	T_j	+ 125	°C
Durchlassstrom Forward current	I_F	70	mA
Stoßstrom Surge current $t \leq 10 \mu s, D = 0.1$	I_{FM}	0.1	A
Sperrspannung ¹⁾ Reverse voltage	V_R	12	V
Leistungsaufnahme Power consumption $T_A \leq 25 \text{ °C}$	P_{tot}	180	mW
Wärmewiderstand Thermal resistance Sperrschicht/Umgebung Junction/ambient	$R_{th JA}$	300	K/W
Sperrschicht/Löt看pad Junction/soldering point Montage auf PC-Board FR 4 (Padgröße $\geq 16 \text{ mm}^2$) mounted on PC board FR 4 (pad size $\geq 16 \text{ mm}^2$)	$R_{th JS}$	130	K/W

¹⁾ für kurzzeitigen Betrieb geeignet / suitable for short term application

Kennwerte ($T_A = 25\text{ °C}$)

Characteristics

Bezeichnung Parameter	Symbol Symbol	Werte Values				Einheit Unit
		LS	LA	LO	LY	
Wellenlänge des emittierten Lichtes (typ.) Wavelength at peak emission $I_F = 50\text{ mA}$	λ_{peak}	645	624	610	594	nm
Dominantwellenlänge ¹⁾ (typ.) Dominant wavelength $I_F = 50\text{ mA}$	λ_{dom}	633 ± 6	617 -5/+7	606 -6/+3	587 -7/+8	nm
Spektrale Bandbreite bei 50 % $I_{\text{rel max}}$ (typ.) Spectral bandwidth at 50 % $I_{\text{rel max}}$ $I_F = 50\text{ mA}$	$\Delta\lambda$	15	18	16	15	nm
Abstrahlwinkel bei 50 % I_V (Vollwinkel) (typ.) Viewing angle at 50 % I_V	2ϕ	30	30	30	30	Grad deg.
Durchlassspannung ²⁾ (min.) Forward voltage (typ.) $I_F = 50\text{ mA}$ (max.)	V_F V_F V_F	1.9 ³⁾ 2.2 2.5	1.9 ⁴⁾ 2.2 2.5	1.9 2.2 2.5	1.9 ³⁾ 2.2 2.5	V V V
Sperrstrom (typ.) Reverse current (max.) $V_R = 12\text{ V}$	I_R I_R	0.01 10	0.01 10	0.01 10	0.01 10	μA μA
Temperaturkoeffizient von λ_{peak} (typ.) Temperature coefficient of λ_{peak} $I_F = 50\text{ mA}; -10\text{ °C} \leq T \leq 100\text{ °C}$	$TC_{\lambda_{\text{peak}}}$	0.15	0.15	0.14	0.13	nm/K
Temperaturkoeffizient von λ_{dom} (typ.) Temperature coefficient of λ_{dom} $I_F = 50\text{ mA}; -10\text{ °C} \leq T \leq 100\text{ °C}$	$TC_{\lambda_{\text{dom}}}$	0.05	0.07	0.08	0.10	nm/K
Temperaturkoeffizient von V_F (typ.) Temperature coefficient of V_F $I_F = 50\text{ mA}; -10\text{ °C} \leq T \leq 100\text{ °C}$	TC_V	-3.4	-3.7	-3.7	-3.7	mV/K
Optischer Wirkungsgrad (typ.) Optical efficiency $I_F = 50\text{ mA}$	η_{opt}	18	24	24	24	lm/W

¹⁾ Wellenlängen werden mit einer Stromeinprägedauer von 25 ms und einer Genauigkeit von $\pm 1\text{ nm}$ ermittelt.
Wavelengths are tested at a current pulse duration of 25 ms and a tolerance of $\pm 1\text{ nm}$.

²⁾ Durchlassspannungsgruppen werden mit einer Stromeinprägedauer von 1 ms und einer Genauigkeit von $\pm 0,05\text{ V}$ ermittelt.
Forward voltage groups are tested at a current pulse duration of 1 ms and a tolerance of $\pm 0.05\text{ V}$.

1) Wellenlängengruppen
Wavelength groups

Gruppe Group	amber		orange		yellow		Einheit Unit
	min.	max.	min.	max.	min.	max.	
2	612	616	600	603	580	583	nm
3	616	620	603	606	583	586	nm
4	620	624	606	609	586	589	nm
5					589	592	nm
6					592	595	nm

3) Durchlassspannungsgruppen für
super-rot / orange / gelb
Forward voltage groups for
super-red / orange / yellow

Gruppe Group	Durchlassspannung Forward voltage		Einheit Unit
	min.	max.	
3	1.9	2.2	V
4	2.2	2.5	V

4) Durchlassspannungsgruppen für amber
Forward voltage groups for amber

Gruppe Group	Durchlassspannung Forward voltage		Einheit Unit
	min.	max.	
3A	1.90	2.05	V
3B	2.05	2.20	V
4A	2.20	2.35	V
4B	2.35	2.50	V

Helligkeits-Gruppierungsschema
Luminous Intensity Groups

Lichtgruppe Luminous Intensity Group	Partieller Lichtfluss Partial Flux E_v [lux]	Lichtstärke Luminous Intensity I_v [mcd]	Lichtstrom Luminous Flux Φ_v [lm]
BB	2240 ... 2800	2400 (typ.)	1200 (typ.)
CA	2800 ... 3550	3000 (typ.)	1500 (typ.)
CB	3550 ... 4500	3800 (typ.)	1900 (typ.)
DA	4000 ... 5600	4700 (typ.)	2400 (typ.)
DB	5600 ... 7100	6000 (typ.)	3000 (typ.)
EA	7100 ... 9000	7600 (typ.)	3700 (typ.)

Helligkeitswerte werden mit einer Stromeinprägedauer von 25 ms und einer Genauigkeit von $\pm 11\%$ ermittelt.
 Luminous intensity is tested at a current pulse duration of 25 ms and a tolerance of $\pm 11\%$.

Gruppenbezeichnung auf Etikett
Group Name on Label

Beispiel: DA-2-3A

Example: DA-2-3A

Partieller Lichtfluss Partial Flux Group	Halbgruppe Half Group	Wellenlänge Wavelength	Durchlassspannung Forward Voltage
D	A	2	3A

Prinzipieller Meßaufbau für partial flux Messung
Schematic Test Methode for partial flux measurement

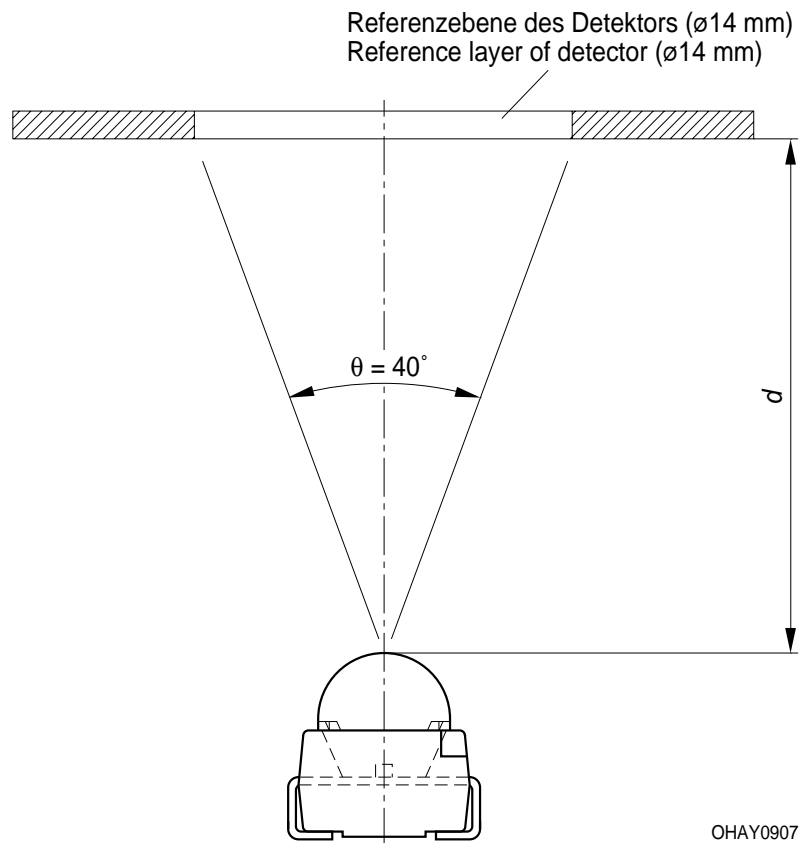

Relative spektrale Emission $I_{rel} = f(\lambda)$, $T_A = 25\text{ °C}$, $I_F = 50\text{ mA}$

Relative Spectral Emission

$V(\lambda)$ = spektrale Augenempfindlichkeit

Standard eye response curve

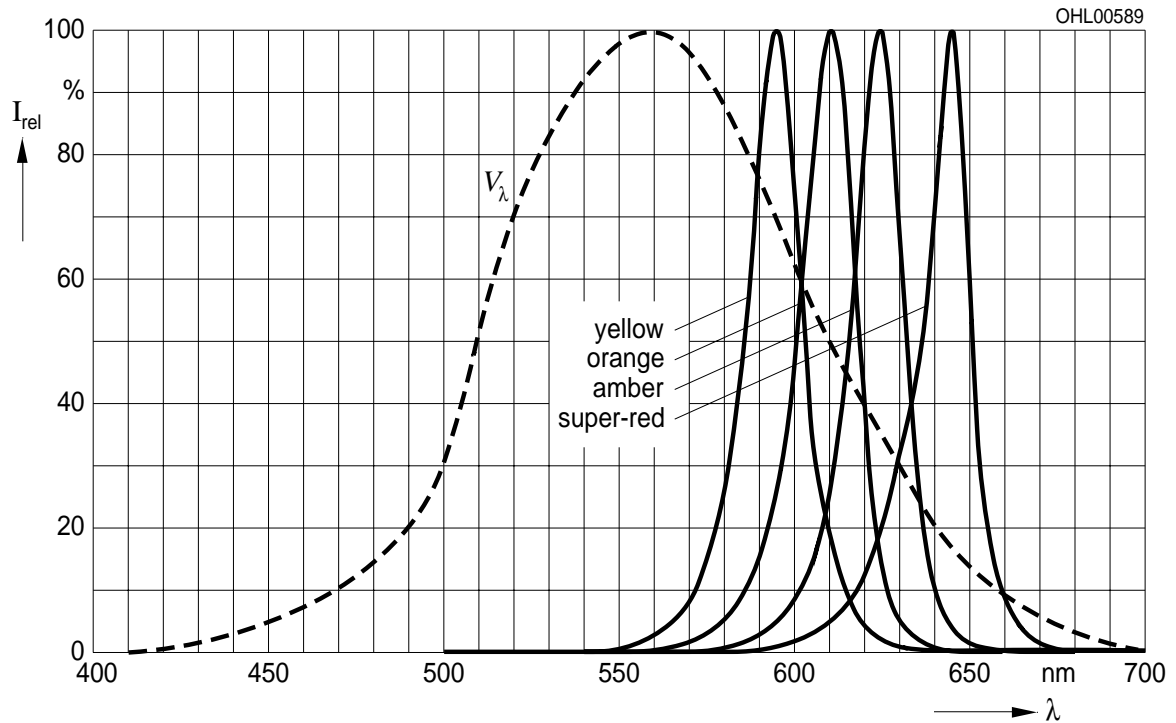

Abstrahlcharakteristik $I_{rel} = f(\varphi)$

Radiation Characteristic

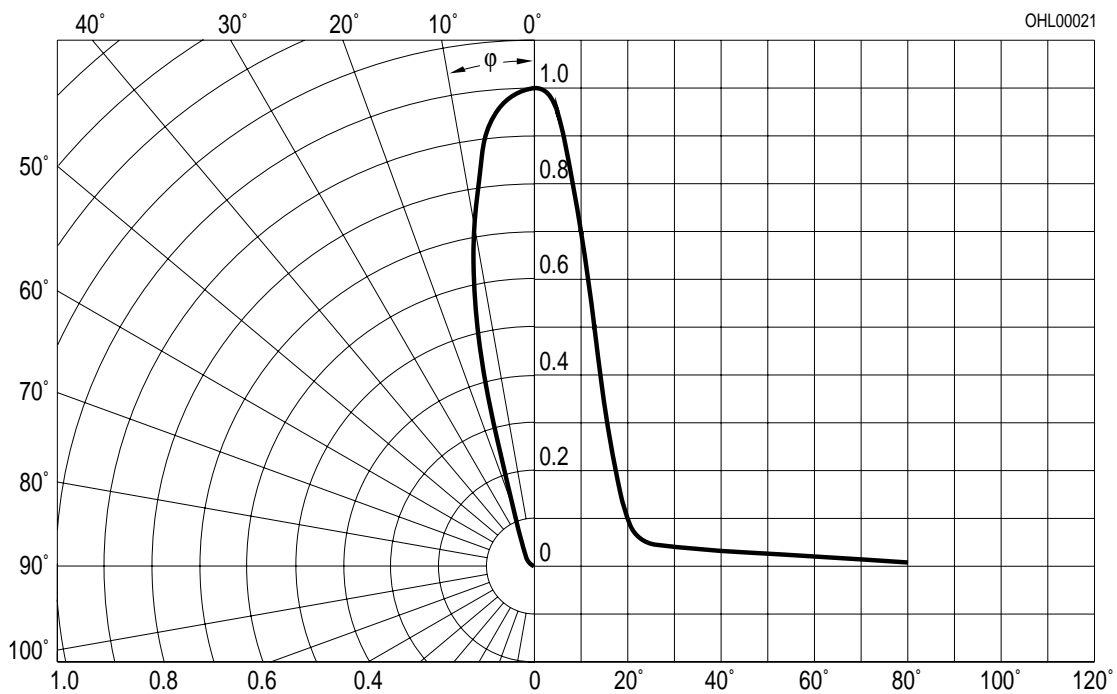

Durchlassstrom $I_F = f(V_F)$
Forward Current

$T_A = 25\text{ °C}$

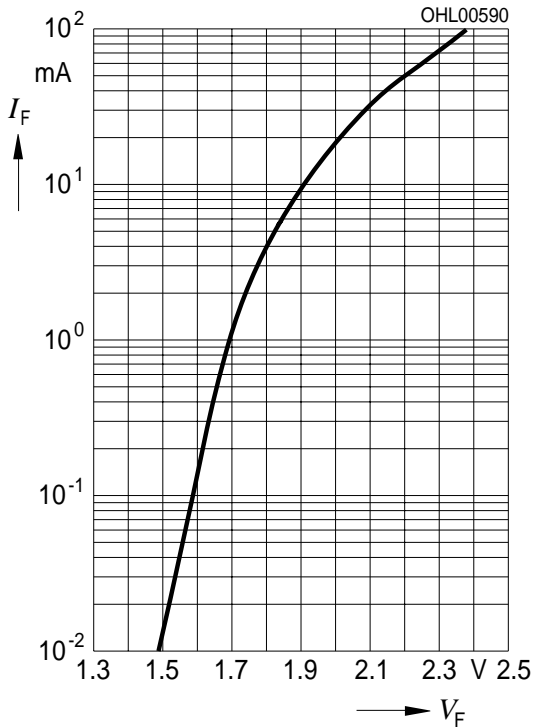

Relative Lichtstärke $I_V/I_{V(50\text{ mA})} = f(I_F)$
Relative Luminous Intensity

$T_A = 25\text{ °C}$

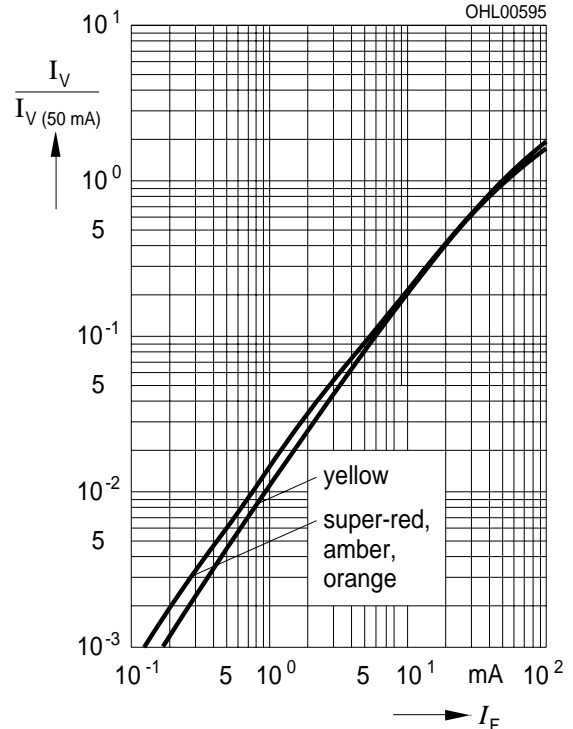

Maximal zulässiger Durchlassstrom $I_F = f(T)$
Max. Permissible Forward Current

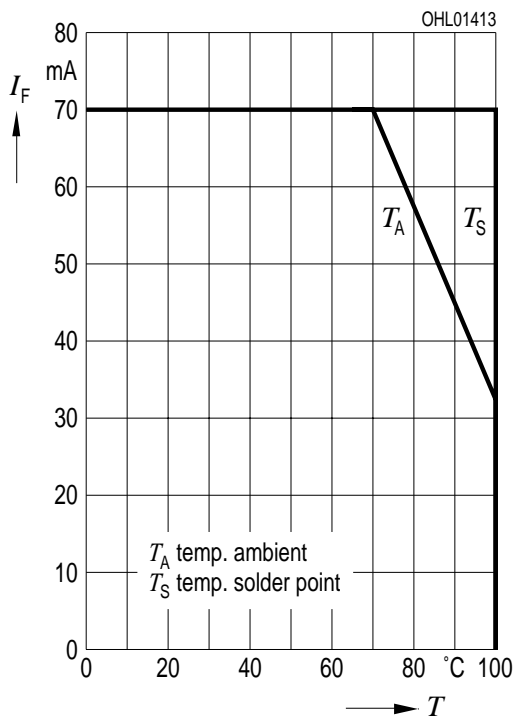

Relative Lichtstärke $I_V/I_{V(25\text{ °C})} = f(T_A)$
Relative Luminous Intensity

$I_F = 50\text{ mA}$

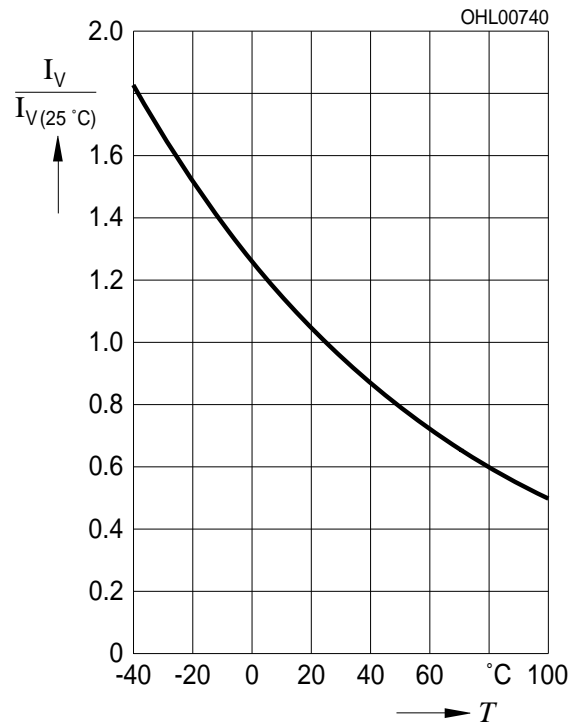

Zulässige Impulsbelastbarkeit $I_F = f(t_p)$
Permissible Pulse Handling Capability
 Duty cycle $D =$ parameter, $T_A = 25\text{ °C}$

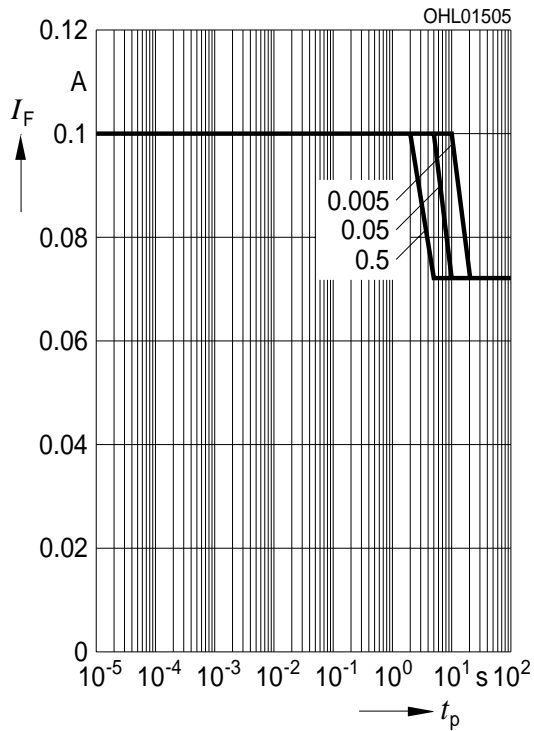

Zulässige Impulsbelastbarkeit $I_F = f(t_p)$
Permissible Pulse Handling Capability
 Duty cycle $D =$ parameter, $T_A = 85\text{ °C}$

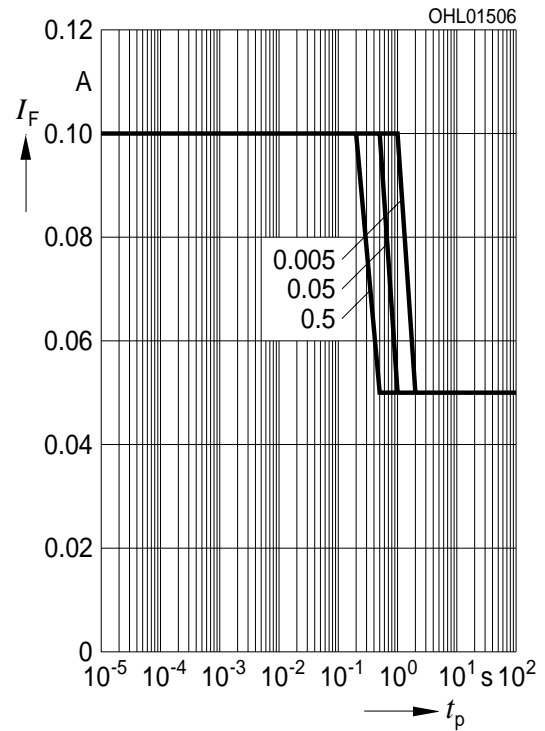

Maßzeichnung
Package Outlines

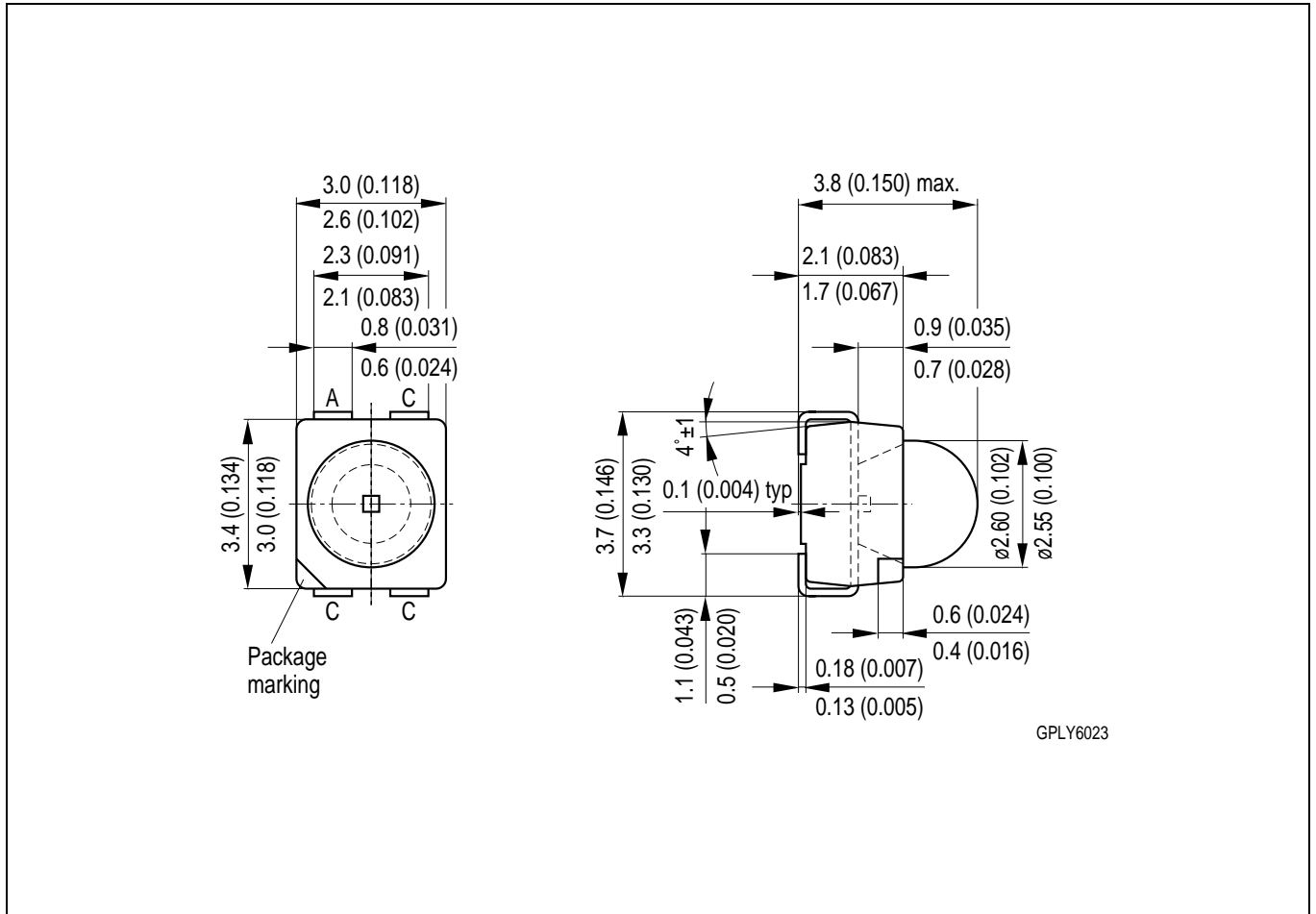

Maße werden wie folgt angegeben: mm (inch) / Dimensions are specified as follows: mm (inch).

Gewicht / Approx. weight: 38 mg

Lötbedingungen Vorbehandlung nach JEDEC Level 2
Soldering Conditions Preconditioning acc. to JEDEC Level 2

IR-Reflow Lötprofil (nach IPC 9501)
IR Reflow Soldering Profile (acc. to IPC 9501)

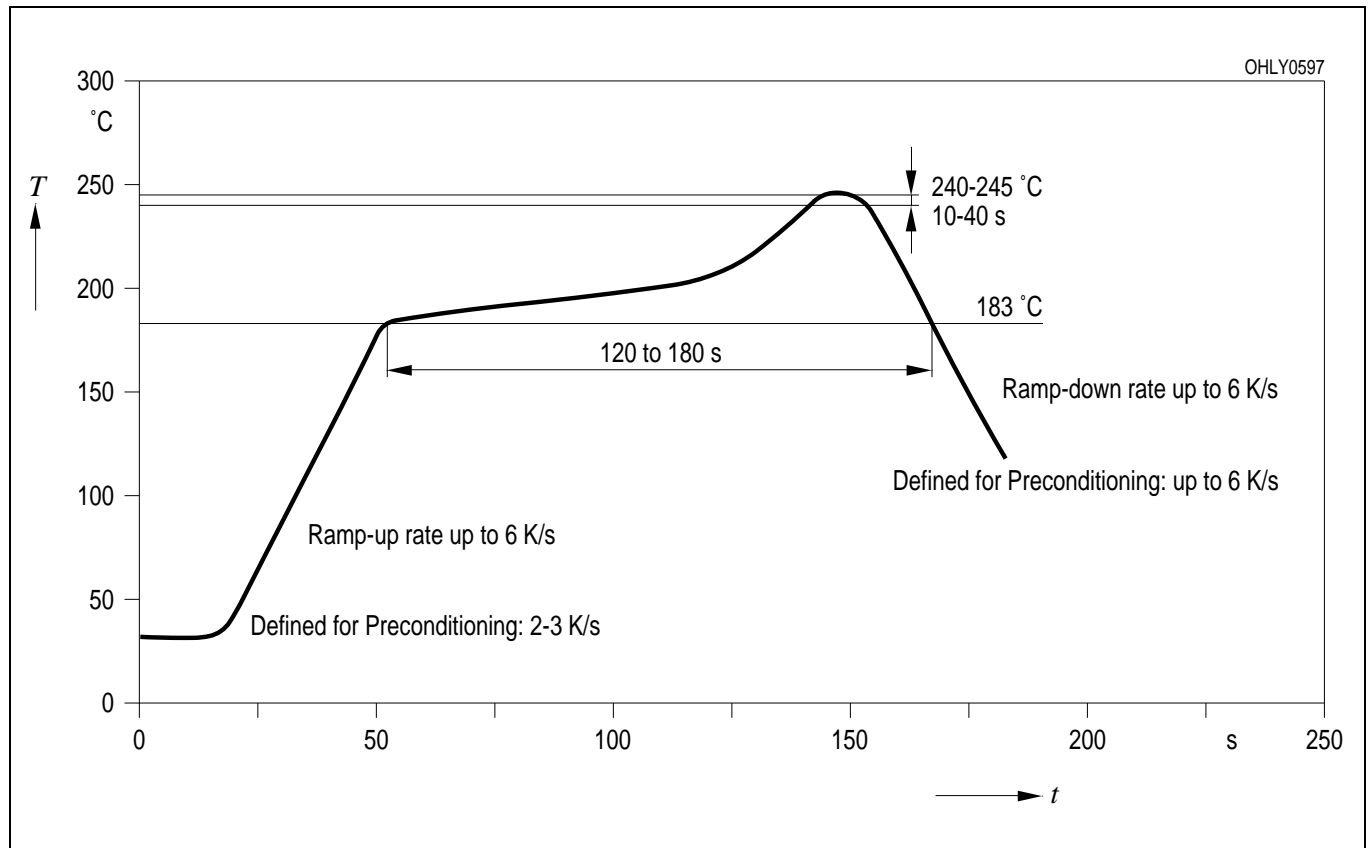

Wellenlötten (TTW) (nach CECC 00802)
TTW Soldering (acc. to CECC 00802)

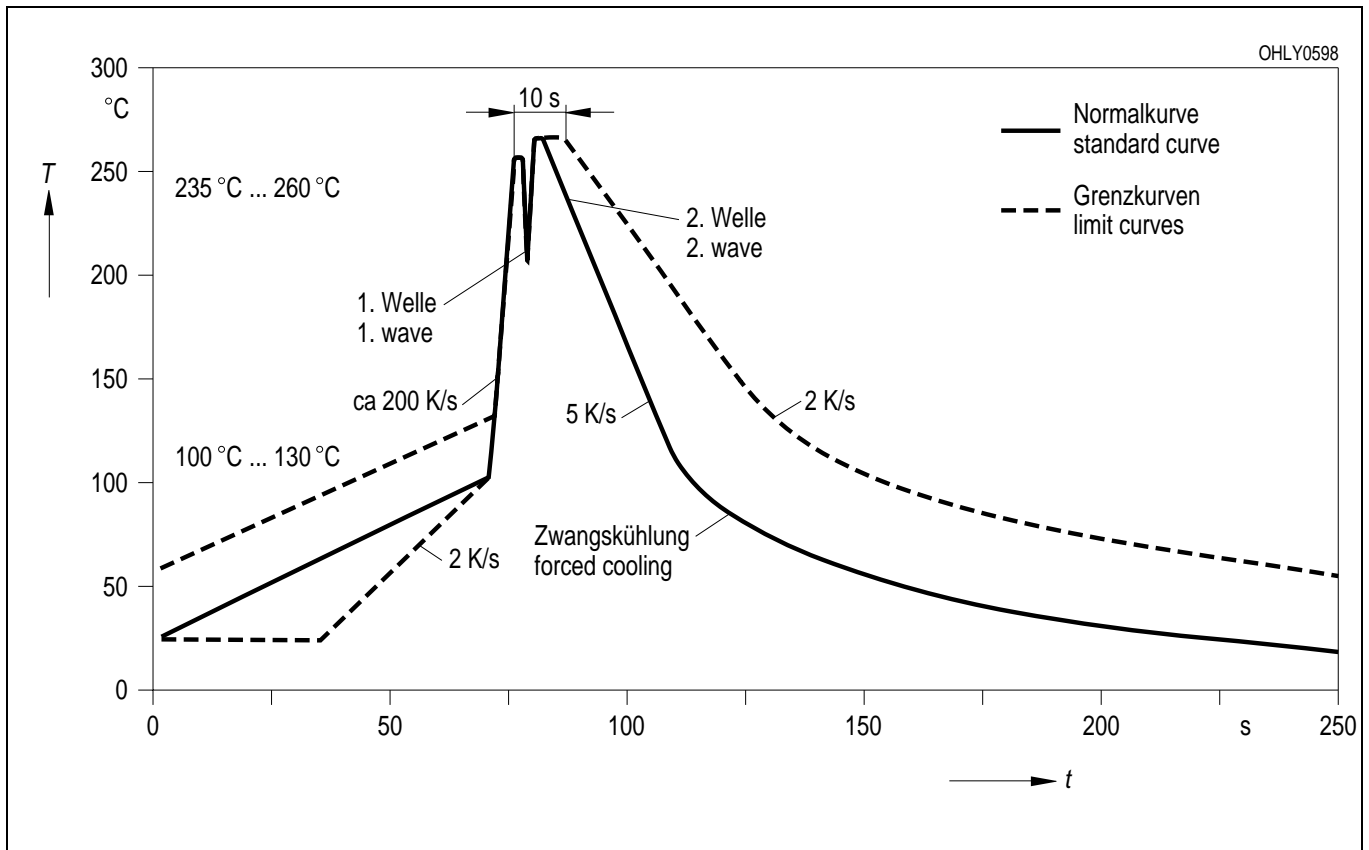

Maße werden wie folgt angegeben: mm (inch) / Dimensions are specified as follows: mm (inch).

Empfohlenes Lötpad Design IR Reflow Lötten
Recommended Solder Pad IR Reflow Soldering

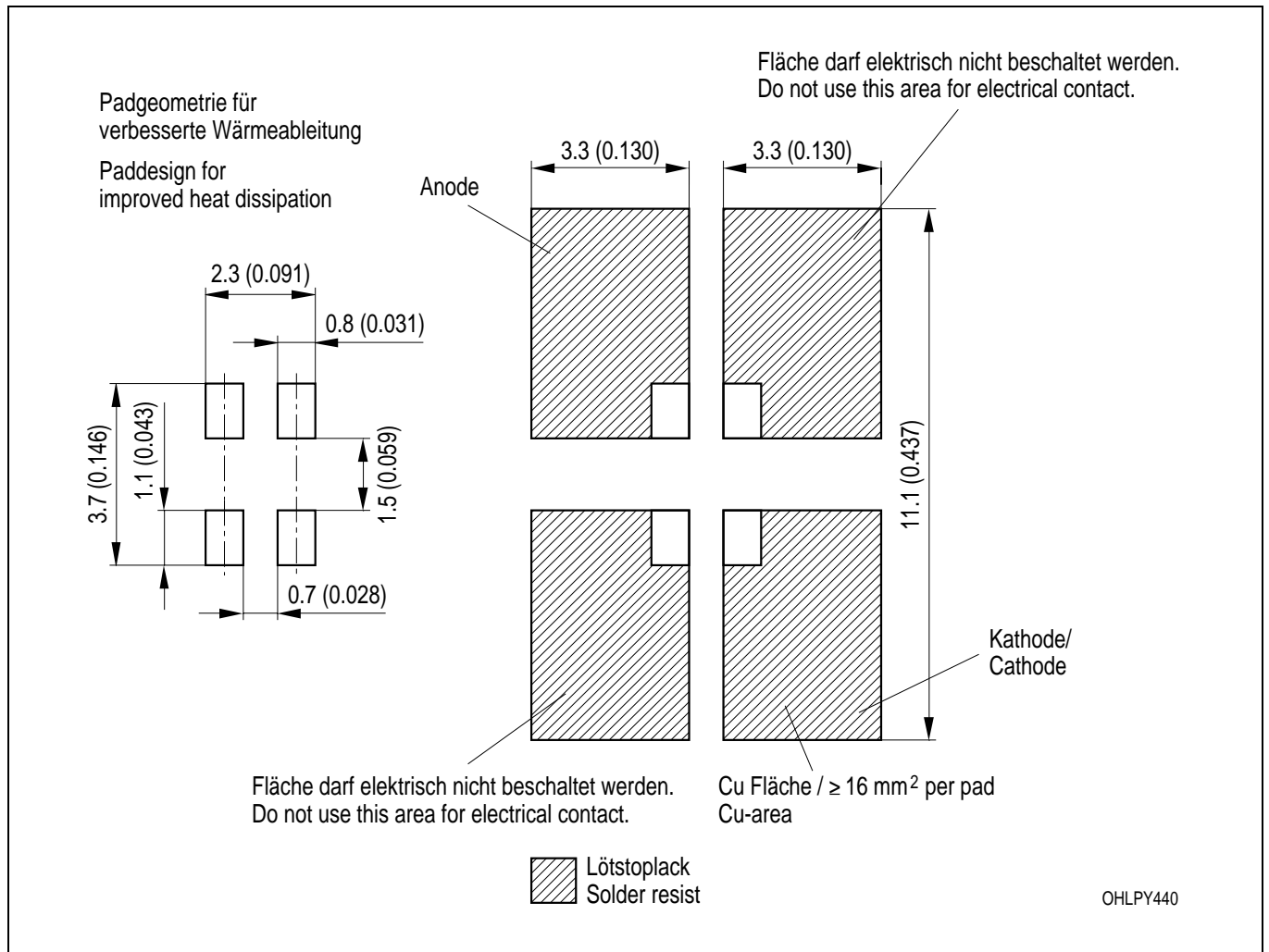

Empfohlenes Lötpaddesign Wellenlöten (TTW)
Recommended Solder Pad TTW Soldering

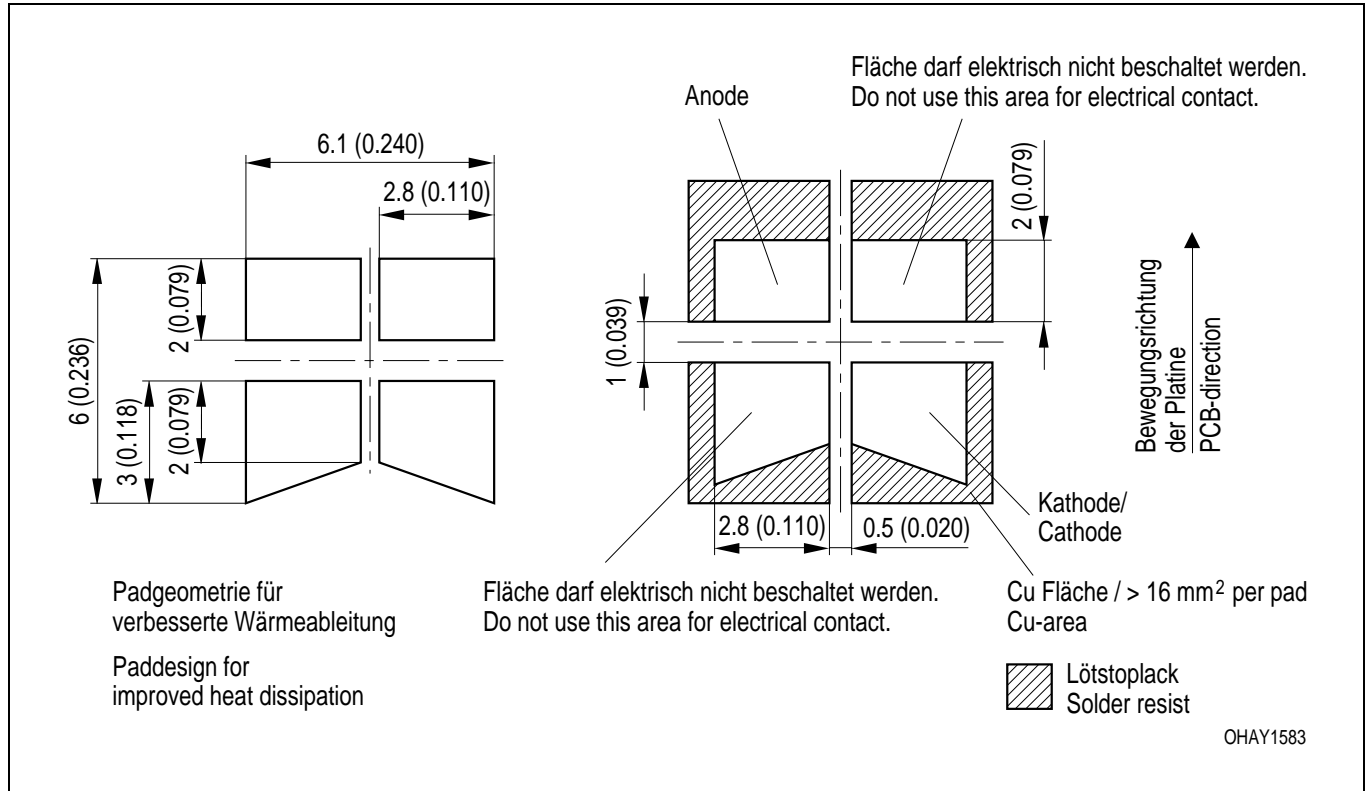

Maße werden wie folgt angegeben: mm (inch) / Dimensions are specified as follows: mm (inch).

Gurtung / Polarität und Lage Verpackungseinheit 2000/Rolle, ø330 mm
Method of Taping / Polarity and Orientation Packing unit 2000/reel, ø330 mm

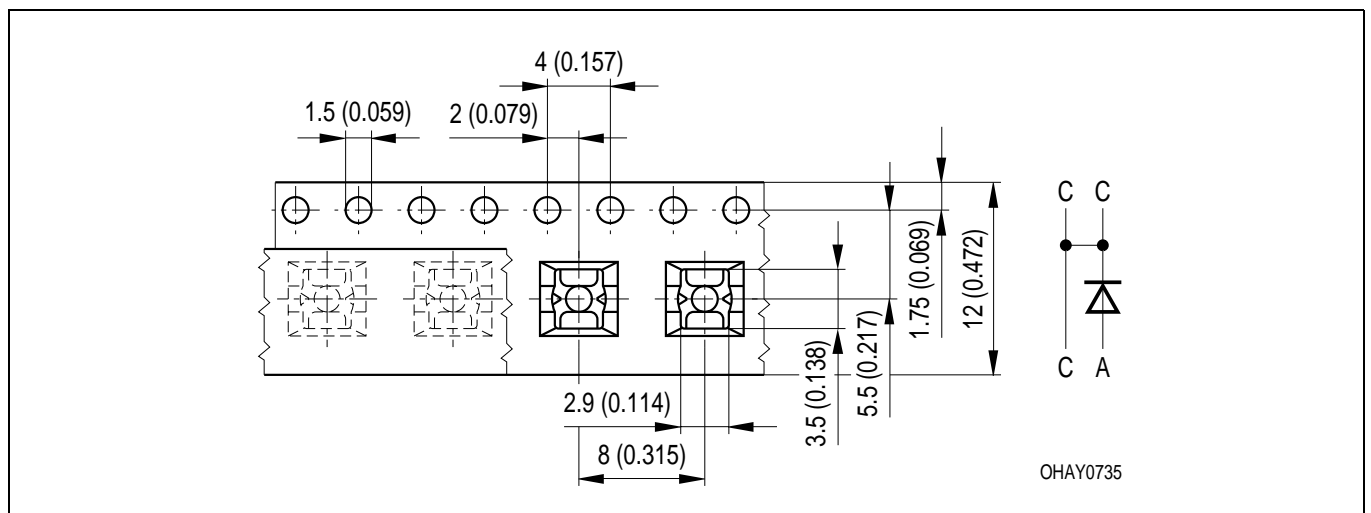

Maße werden wie folgt angegeben: mm (inch) / Dimensions are specified as follows: mm (inch).

Revision History: 2003-06-02		Date of change
Previous Version: 2003-03-04		
Page	Subjects (major changes since last revision)	
2	wavelength grouping for yellow and orange	
2	forward voltage grouping for amber, super red and yellow	
2, 5	implemeted partial flux measurement	
4	value (orange; temperature coefficient of V_f from -1.8 to -3.7 mV/K)	2002-06-14
15	annotations	2002-07-23
13	new IR solder pad (OHLPY439 to OHLPY440)	2002-08-05
3, 4	value (reverse voltage from 5 V to 12 V)	2002-09-18
1	picture of the device	2002-10-15
6	Schematic Test Methode for partial flux measurement	2002-11-28
all	implementation of LS E63B	2002-12-13
5	forward voltage groups for orange	2003-01-30
2	orange: ordering code	2003-03-04
13	new recommended solder pad	2003-06-02

Published by OSRAM Opto Semiconductors GmbH
 Wernerwerkstrasse 2, D-93049 Regensburg

© All Rights Reserved.

Attention please!

The information describes the type of component and shall not be considered as assured characteristics. All typical data and graphs are basing on representative samples, but don't represent the production range. If requested, e.g. because of technical improvements, these typ. data will be changed without any further notice. Terms of delivery and rights to change design reserved. Due to technical requirements components may contain dangerous substances. For information on the types in question please contact our Sales Organization. If printed or downloaded, please find the latest version in the Internet.

Packing

Please use the recycling operators known to you. We can also help you – get in touch with your nearest sales office. By agreement we will take packing material back, if it is sorted. You must bear the costs of transport. For packing material that is returned to us unsorted or which we are not obliged to accept, we shall have to invoice you for any costs incurred.

Components used in life-support devices or systems must be expressly authorized for such purpose! Critical components ¹ may only be used in life-support devices or systems ² with the express written approval of OSRAM OS.

¹ A critical component is a component used in a life-support device or system whose failure can reasonably be expected to cause the failure of that life-support device or system, or to affect its safety or the effectiveness of that device or system.

² Life support devices or systems are intended (a) to be implanted in the human body, or (b) to support and/or maintain and sustain human life. If they fail, it is reasonable to assume that the health of the user may be endangered.