



■ **Features**

- Universal AC input / Full range (up to 277VAC)
- 2 pole AC inlet IEC320-C8
- Built-in active PFC function
- Constant current design
- Protections: Short circuit
- Cooling by free air convection
- Fully isolated plastic case
- Class II power unit, no FG
- No load power consumption < 0.15W
- Low cost, high reliability
- 100% full load burn-in test
- 3 years warranty

■ **Applications**

- Indoor LED lighting
- Office lighting
- Commercial lighting
- Indoor LED decorative lighting

■ **Description**

GSC18B series is a 18W external desktop LED power supply with PFC function. The design of this product is based on the “plug and play” concept for adaptors. The AC input side exploits the 2-Pin (Class II, no FG) international standard inlet IEC320-C8, and the output side is equipped with the highly accepted DC connector (2.1x5.5x11mm) in the market. This product accepts 90~277VAC input and offers various constant current output models with 350mA/500mA/700mA/1050mA/1400mA. The design complies with the lighting requirements of EMI EN55015 and the harmonic current demand per EN61000-3-2 Class C. In addition, the no load power consumption is less than 0.15W, and the setup time is less than 500ms, making GSC18B conform to the ErP regulation required by European Union for lighting systems as well.

■ **Model Encoding**

**GSC 18 B - 350**

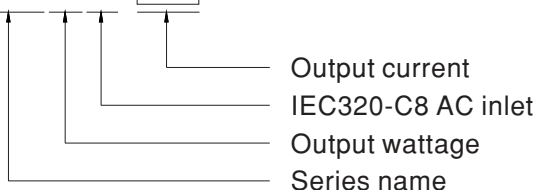



## SPECIFICATION

MODEL		GSC18B-350	GSC18B-500	GSC18B-700	GSC18B-1050	GSC18B-1400
OUTPUT	RATED CURRENT	350mA	500mA	700mA	1050mA	1400mA
	OPERATING VOLTAGE RANGE <small>Note.4</small>	26 ~ 52V	18 ~ 36V	13 ~ 26V	8 ~ 17V	6 ~ 13V
	CURRENT ACCURACY <small>Note.3</small>	± 8.0%				
	RATED POWER	18.2W	18W	18.2W	17.9W	18.2W
	RIPPLE & NOISE (max.) <small>Note.2</small>	4.6Vp-p	3Vp-p	2.5Vp-p	1.6Vp-p	1.6Vp-p
	NO LOAD OUTPUT VOLTAGE (max.)	70V	50V	35V	25V	18V
SETUP TIME	500ms / 230VAC 1000ms / 115VAC at full load					
INPUT	VOLTAGE RANGE	90 ~ 277VAC 127 ~ 392VDC				
	FREQUENCY RANGE	47 ~ 63Hz				
	POWER FACTOR (Typ.)	PF>0.98/115VAC, PF>0.92/230VAC, PF>0.91/277VAC at full load (Please refer to "Power Factor Characteristic" curve)				
	TOTAL HARMONIC DISTORTION	Total harmonic distortion will be lower than 20% when output loading is 75% or higher				
	EFFICIENCY (Typ.)	89%	88.5%	88.5%	87%	85.5%
	AC CURRENT (Typ.)	0.6A/115VAC	0.3A/230VAC	0.2A/277VAC		
	INRUSH CURRENT(max.)	COLD START 17A(t <sub>width</sub> =110μs measured at 50% I <sub>peak</sub> ) at 230VAC				
LEAKAGE CURRENT	<0.5mA / 240VAC					
PROTECTION	SHORT CIRCUIT	Hiccup mode, recovers automatically after fault condition is removed.				
ENVIRONMENT	WORKING TEMP.	-30 ~ +50°C (Refer to "Derating Curve")				
	WORKING HUMIDITY	20 ~ 95% RH non-condensing				
	STORAGE TEMP., HUMIDITY	-40 ~ +80°C, 10 ~ 95% RH				
	TEMP. COEFFICIENT	± 0.03%/°C (0 ~ 50°C)				
	VIBRATION	10 ~ 500Hz, 2G 12min./1cycle, period for 72min. each along X, Y, Z axes				
SAFETY & EMC	SAFETY STANDARDS	Dekra GS/ENEC EN61347-1, EN61347-2-13 listed, EN62384, GB19510.1, GB19510.14, EAC TP TC 004 approved				
	WITHSTAND VOLTAGE	I/P-O/P:3.75KVAC				
	ISOLATION RESISTANCE	I/P-O/P:100M Ohms / 500VDC / 25°C / 70% RH				
	EMC EMISSION	Compliance to EN55015, EN61000-3-2 Class C (≥50% load) ; EN61000-3-3, GB17743, GB17625.1, EAC TP TC 020				
	EMC IMMUNITY	Compliance to EN61000-4-2,3,4,5,6,8,11,EN61547, light industry level, criteria A, EAC TP TC 020				
OTHERS	MTBF	338.3K hrs min. MIL-HDBK-217F (25°C)				
	DIMENSION	79*54*33mm (L*W*H)				
	PACKING	191g ; 60pcs / 12.5kg / CARTON				
CONNECTOR	PLUG	2.1φ * 5.5φ * 11mm, tuning fork type, center positive for stock				
	CABLE	See page 4 ; Other type available by customer requested				
NOTE	<p>1. All parameters NOT specially mentioned are measured at 230VAC input, rated load and 25°C of ambient temperature.</p> <p>2. Ripple &amp; noise are measured at 20MHz of bandwidth by using a 12" twisted pair-wire terminated with a 0.1uf &amp; 47uf parallel capacitor.</p> <p>3. Please see "AC input voltage drop vs. output current characteristics" table.</p> <p>4. Constant current operation region is within 50% ~100% rated output voltage. This is the suitable operation region for LED related applications, but please reconfirm special electrical requirements for some specific system design.</p> <p>5. Direct connecting to LEDs is suggested, but is not suitable for using additional drivers.</p> <p>※ Product Liability Disclaimer : For detailed information, please refer to <a href="https://www.meanwell.com/serviceDisclaimer.aspx">https://www.meanwell.com/serviceDisclaimer.aspx</a></p>					

■ Block Diagram

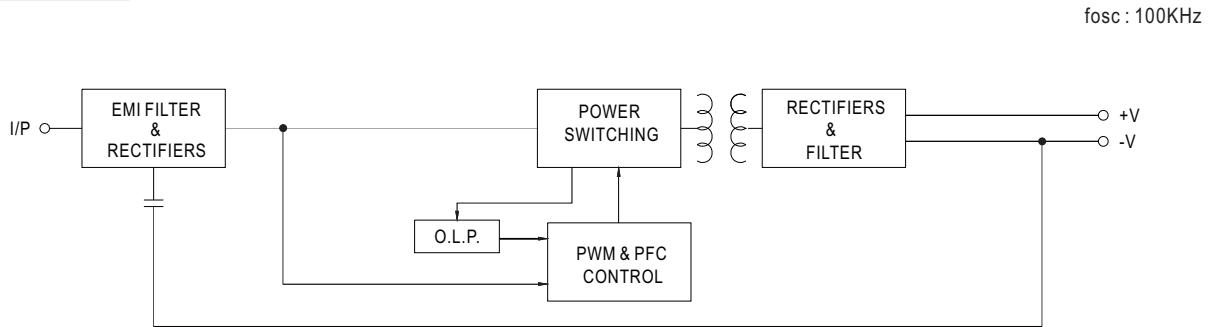

■ Derating Curve

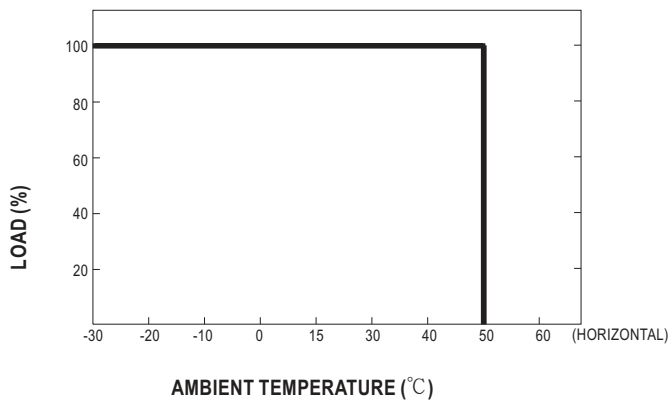

■ Static Characteristics

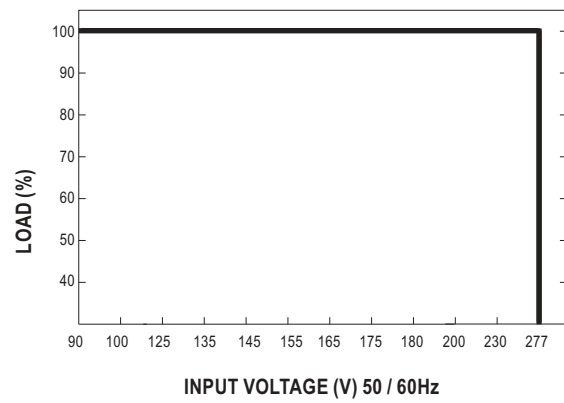

■ Power Factor Characteristic

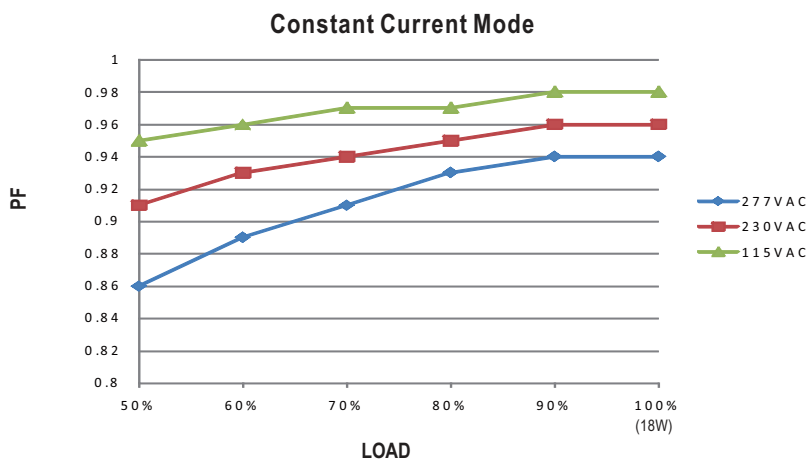

**EFFICIENCY vs LOAD (GSC18B-350)**

GSC18B series possess superior working efficiency that up to 89% can be reached in field applications.

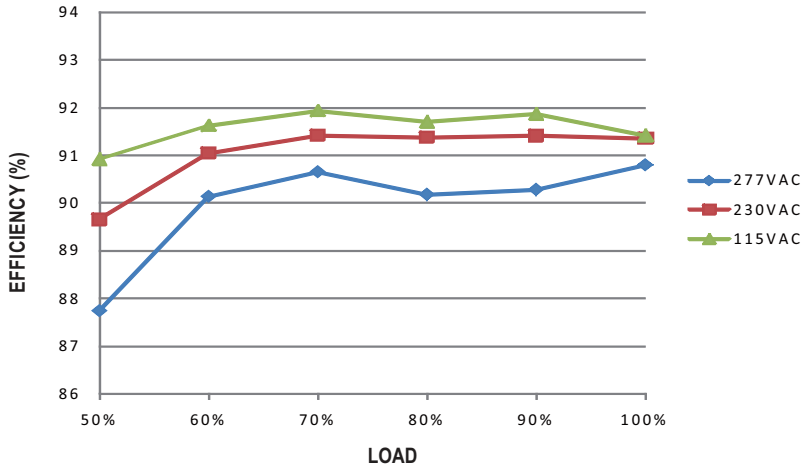

**AC input voltage drop vs. Output current characteristics**

AC input drop	10%	8%	5%	3%
Io drop	<25%	<23%	<15%	<10%

Note : Output current will return to the rated value within 80ms

**Mechanical Specification**

Unit:mm

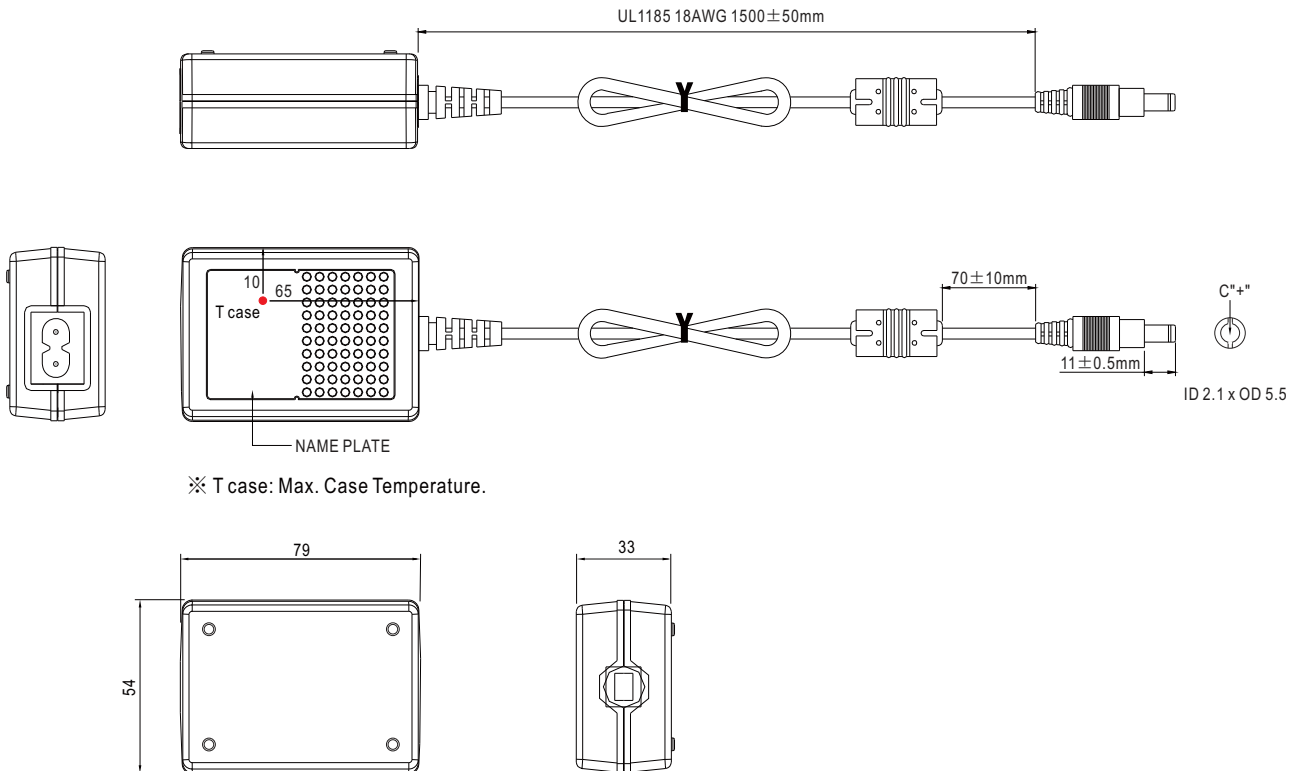

**Installation Manual**

Please refer to : <http://www.meanwell.com/manual.html>