

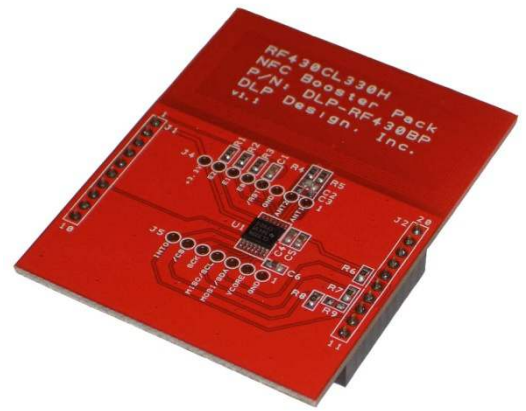

DLP-RF430BP

BoosterPack User's Guide



FEATURES:

- Texas Instruments RF430CL330H, Rev D Silicon
- ISO14443B Compliant
- 13.56MHz RF Interface Supports up to 848 Kbps
- NFC Tag Type 4 Compliant
- 3K SRAM Bytes Available for NDEF Message Storage
- Automatic Checking of NDEF Structure
- Interrupt to Indicate End of Read or End of Write
- Onboard Antenna or Optional External Antenna Connection (Remove R2 and R3)
- Operational Power Supplied by the LaunchPad (Purchased Separately)

1.0 INTRODUCTION

The DLP Design DLP-RF430BP BoosterPack is used to demonstrate the capabilities of the RF430CL330H and help aid in the development process by providing a working hardware/firmware reference example for NFC operations. This BoosterPack demonstrates a secure, simplified pairing process for Bluetooth® and Wi-Fi connections with the only dynamic NFC tag device designed specifically for NFC connection handover and service-interface functions.

The DLP-RF430BP BoosterPack is an add-on board designed to fit TI's MCU LaunchPads. This product allows the software application developer to get familiar with the functionalities of the RF430CL330H on their Texas Instruments embedded microcontroller platform of choice without having to worry about designing the antenna.

This document provides direction for RF430CL330H users who wish to implement an NFC tag emulator that is connected to and controlled by a Texas Instruments embedded microcontroller or microprocessor development platform. Examples of such development platforms are the MSP-EXP430G2 LaunchPad and the MSP-EXP430F5529LP LaunchPad.

LaunchPads from Texas Instruments are easy-to-use flash programming and debugging tools for the MSP430, C2000, TIVA, etc. lines of microcontrollers. They feature everything you need to start developing on a Texas Instruments microcontroller device. There is on-board emulation for programming and debugging, on-board button switches, LED's and BoosterPack-compatible pinouts to support a wide range of plug-in modules like the DLP-RF430BP.

Free software development tools are also available, such as TI's Eclipse-based Code Composer Studio. Open-source development is also possible thanks to community-driven projects such as the MSPGCC compiler or Energia, a branch of the popular Wiring framework.

2.0 SCOPE

This document describes the DLP-RF430BP module for evaluation and development purposes in conjunction with Texas Instruments embedded development platforms. This manual does not cover the in-depth details of the RF430CL330H family as these are documented in the datasheets for those parts along with application notes that can be found on their product pages (see the links in Section 3).

3.0 REFERENCES

- DLP-RF430BP: www.dlpdesign.com
- RF430CL330H Product Page: <http://www.ti.com/product/rf430cl330h>
- RF430CL330H Datasheet: <http://www.ti.com/lit/ds/symlink/rf430cl330h.pdf>

4.0 MODULE DESCRIPTION

The DLP-RF430BP BoosterPack (Figure 1) allows NFC connection handover for an alternative carrier like Low Energy (BLE) and Wi-Fi as an easy and intuitive pairing or authentication process with only a tap. As a general NFC interface, the RF430CL330H enables electronic products to communicate with the fast-growing infrastructure of NFC-enabled smart phones, tablets and notebooks.

Connection to Texas Instruments LaunchPad platforms are made via 10-pin, 0.1-inch spaced, 0.025-square inch female headers located on the back of the board. The electrical schematic is available for download from www.dlpdesign.com.

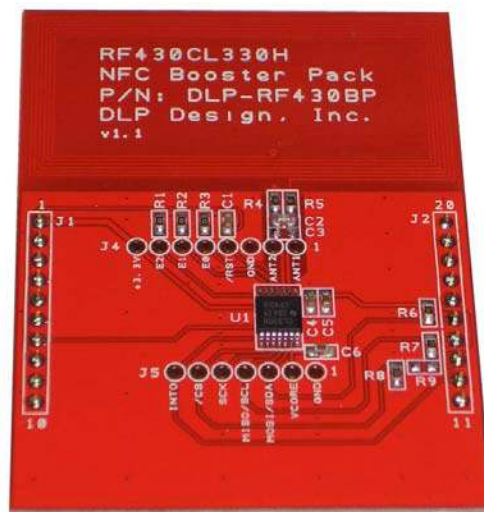

Figure 1. DLP-RF430BP Evaluation Module

5.0 MODULE PINOUT

DLP-RF430BP MODULE PIN CONNECTIONS TO THE LAUNCHPAD	
1	VCC - 3.0V power from the LaunchPad
2	Unused by the DLP-RF430BP
3	Unused by the DLP-RF430BP
4	Unused by the DLP-RF430BP
5	Unused by the DLP-RF430BP
6	Unused by the DLP-RF430BP
7	DATA_CLK - Clock from the microcontroller if in SPI mode. Default: I2C mode.
8	RESET
9	Unused by the DLP-RF430BP
10	Unused by the DLP-RF430BP
11	Unused by the DLP-RF430BP
12	INTO - Interrupt to microcontroller
13	SPI_CS - Chip select from microcontroller for SPI mode
14	MISO/SCL - SPI serial data to the microcontroller if in SPI mode. Clock from microcontroller if in I2C mode.
15	MOSI/SDA - SPI serial data from the microcontroller if in SPI mode. Data to/from microcontroller if in I2C mode.
16	Unused by the DLP-RF430BP
17	Unused by the DLP-RF430BP
18	Unused by the DLP-RF430BP
19	Unused by the DLP-RF430BP
20	GROUND

6.0 QUICK START GUIDE

If using Code Composer to load, edit and compile the demonstration firmware:

1. Remove jumper P1.6 from the G2 LaunchPad.
2. Attach the G2 LaunchPad to the DLP-RF430BP as shown here.



3. Apply power by connecting a USB cable to the LaunchPad.
4. Load (Import) the base application firmware into Code Composer Studio. The firmware project is available for download from this link: <http://www.ti.com/lit/zip/sloc303>
5. Enter Debug mode and test for basic functionality by holding an NFC-enabled smart phone, tablet or notebook close to the onboard loop antenna. The device should display "Hello, world!" for the default NDEF message.

6. Modify the source code as desired to change the default message.

If using Uniflash to load the precompiled .out file:

1. Remove jumper P1.6 from the G2 LaunchPad.
2. Attach the G2 LaunchPad to the DLP-RF430BP as shown here.



3. Apply power by connecting a USB cable to the LaunchPad.
4. Download Uniflash - <http://www.ti.com/tool/uniflash>
5. Make a new target configuration for the MSP430G2553: Click on File, New Target Configuration, which leads you to this window to launch the session:

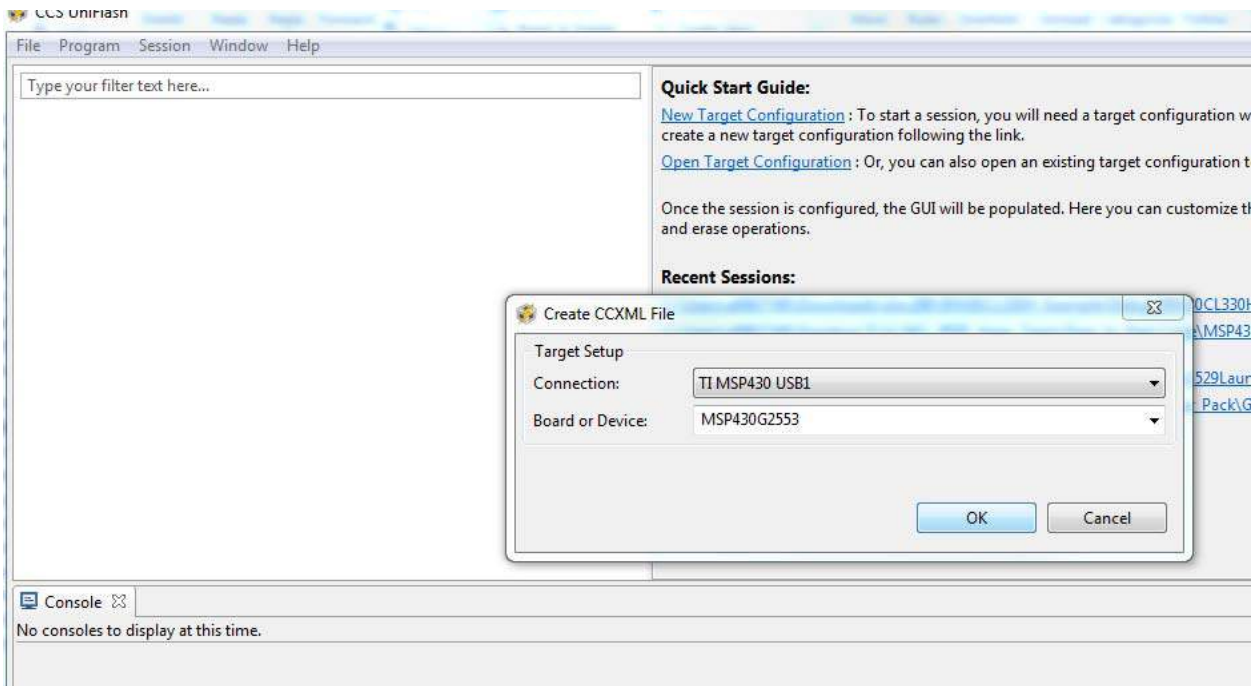

6. Next, click on Program, Load Program, and navigate (using Browse button) to the project files and find the .out file

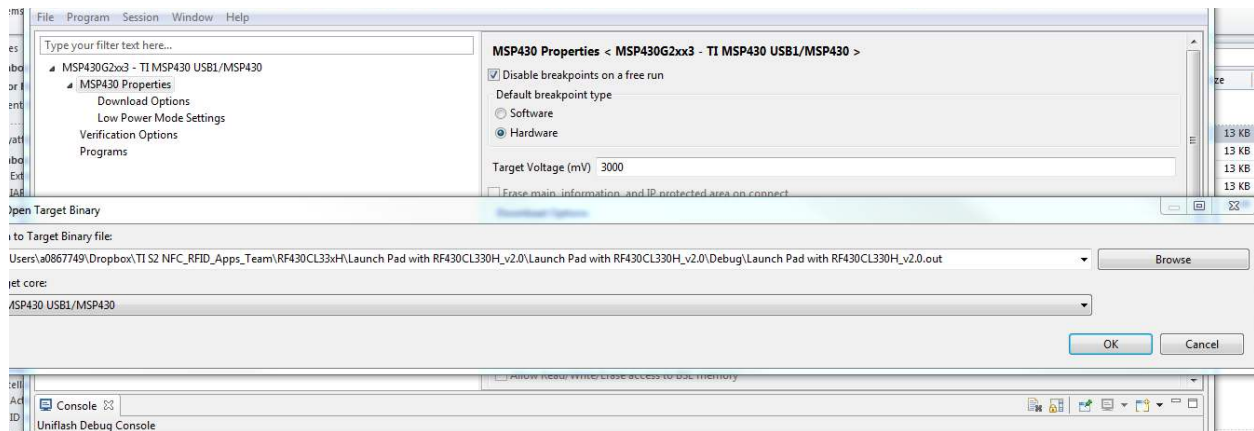

7. Click OK to load the .out file.

8. Cycle power on the LaunchPad (unplug - replug) and the code will be running.

9. Test for basic functionality by holding an NFC-enabled smart phone, tablet or notebook close to the onboard loop antenna. The device should display "Hello, world!" for the default NDEF message.

7.0 BASE APPLICATION FIRMWARE

DLP-RF430BP Module Application Firmware for the various Texas Instruments LaunchPads is available from the DLP Design websites. Visit the appropriate download/product pages for all available firmware project downloads.

8.0 MECHANICAL DIMENSIONS – Inches (mm)

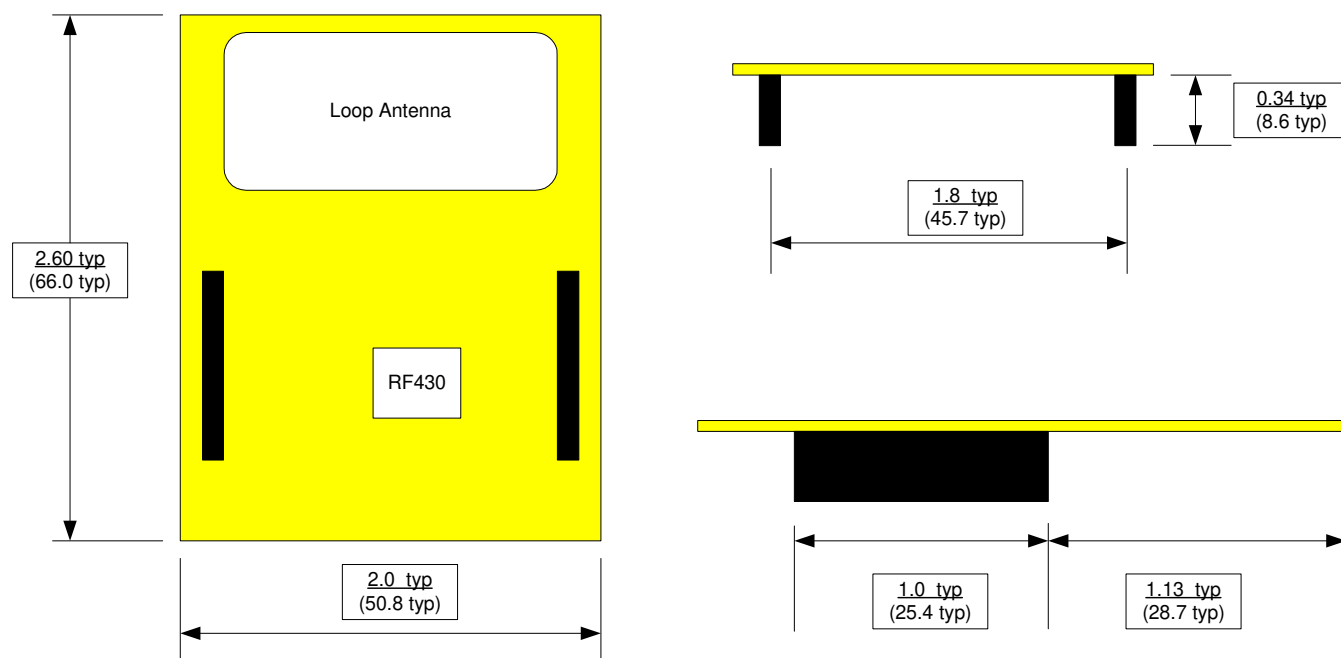

9.0 DISCLAIMER

Neither the whole nor any part of the information contained herein nor the product described in this datasheet may be adapted or reproduced in any material or electronic form without the prior written consent of the copyright holder.

This product and its documentation are supplied on an as-is basis, and no warranty as to their suitability for any particular purpose is either made or implied. DLP Design will not accept any claim for damages whatsoever arising as a result of the use or failure of this product. Your statutory rights are not affected.

This product or any variant of it is not intended for use in any medical appliance, device or system in which the failure of the product might reasonably be expected to result in personal injury.

This document provides preliminary information that may be subject to change without notice.

10.0 CONTACT INFORMATION

DLP Design, Inc.
1605 Roma Lane
Allen, TX 75013

Phone: 469-964-8027
Fax: 415-901-4859
Email: support@dlpdesign.com
Internet: <http://www.dlpdesign.com>

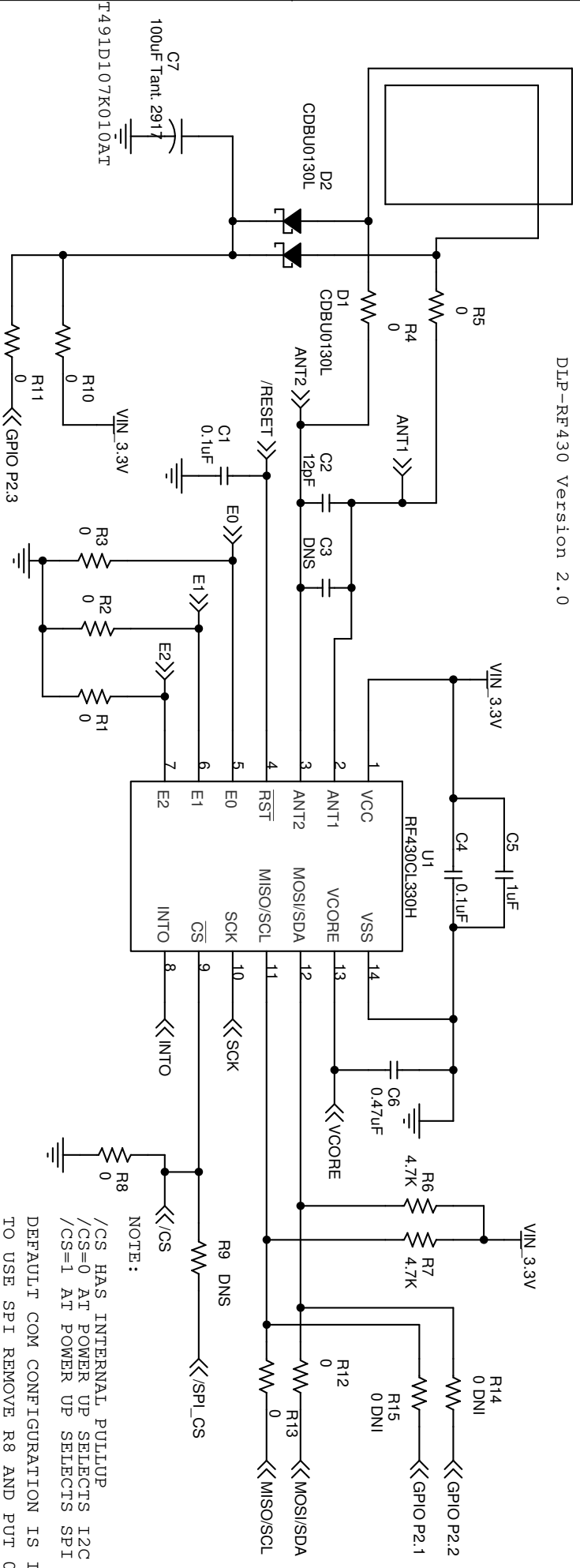

NOTE:
 /CS HAS INTERNAL PULLUP
 /CS=0 AT POWER UP SELECTS I2C
 /CS=1 AT POWER UP SELECTS SPI
 DEFAULT COM CONFIGURATION IS I2C.
 TO USE SPI REMOVE R8 AND PUT 0
 OHM IN R9.

/RST HAS INTERNAL PULLUP

G2 LAUNCH PAD PIN DEFINITION

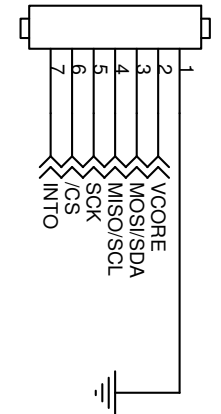
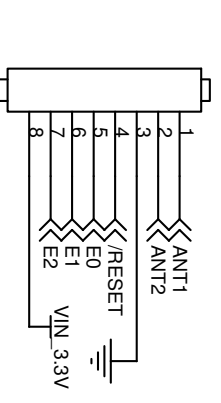
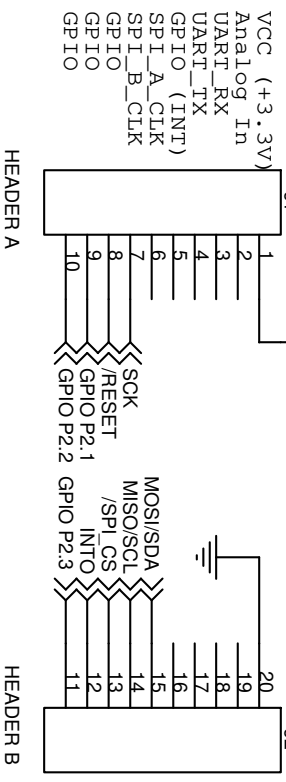

Title		DLP-RF430BP : RF430CL330H Booster Pack
Size	Document Number	DLP-RF430BP
A	Date:	Sunday, April 05, 2015
Sheet		0 of 1
Rev		1.0