

LM4811 Boomer® Audio Power Amplifier Series Dual 105mW Headphone Amplifier with Digital Volume Control and Shutdown Mode

 Check for Samples: [LM4811](#)

FEATURES

- Digital Volume Control Range from +12dB to -33dB
- WSON and VSSOP Surface Mount Packaging
- "Click and Pop" Suppression Circuitry
- No Bootstrap Capacitors Required
- Low Shutdown Current

APPLICATIONS

- Cellular Phones
- MP3, CD, DVD Players
- PDA's
- Portable Electronics

KEY SPECIFICATIONS

- THD+N at 1kHz, 105mW Continuous Average Output Power into 16Ω 0.1 % (typ)
- THD+N at 1kHz, 70mW Continuous Average Power into 32Ω 0.1 % (typ)
- Shutdown Current 0.3 μA (typ)

Connection Diagrams

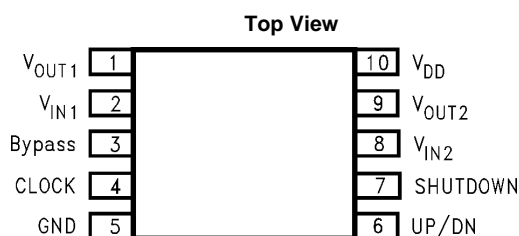

Figure 1. VSSOP Package
See Package Number DGS0010A

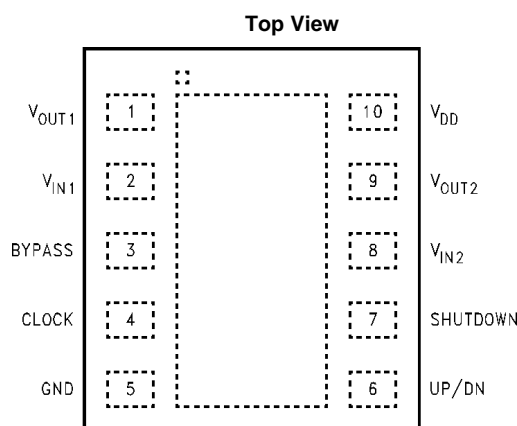

Figure 2. WSON Package
See Package Number NGY0010A

DESCRIPTION

The LM4811 is a dual audio power amplifier capable of delivering 105mW per channel of continuous average power into a 16Ω load with 0.1% (THD+N) from a 5V power supply.

Boomer audio power amplifiers were designed specifically to provide high quality output power with a minimal amount of external components. Since the LM4811 does not require bootstrap capacitors or snubber networks, it is optimally suited for low-power portable systems.

The LM4811 features a digital volume control that sets the amplifier's gain from +12dB to -33dB in 16 discrete steps using a two-wire interface.

The unity-gain stable LM4811 also features an externally controlled, active-high, micropower consumption shutdown mode. It also has an internal thermal shutdown protection mechanism.



Please be aware that an important notice concerning availability, standard warranty, and use in critical applications of Texas Instruments semiconductor products and disclaimers thereto appears at the end of this data sheet.

All trademarks are the property of their respective owners.

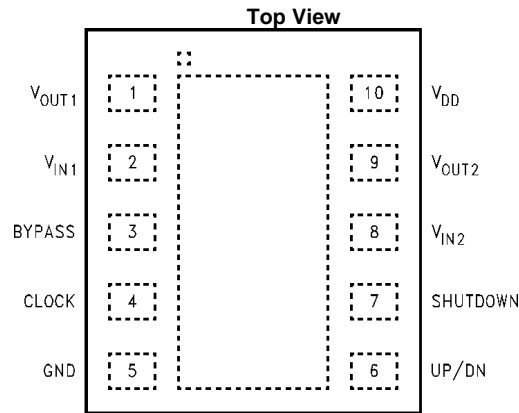
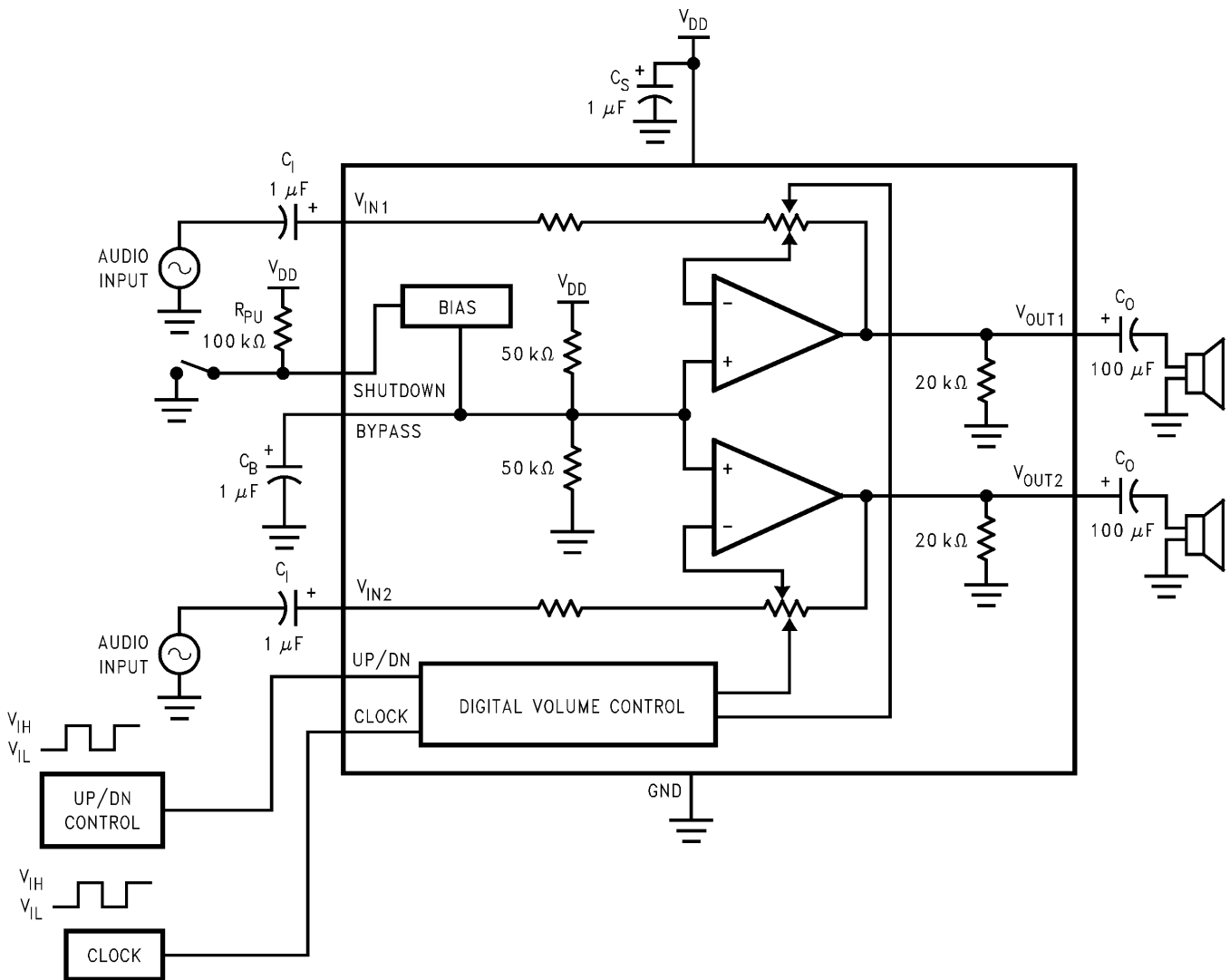

Figure 3. SON Package
See Package Number NHD0010A

Typical Application



*Refer to [Application Information](#) for information concerning proper selection of the input and output coupling capacitors.

Figure 4. Typical Audio Amplifier Application Circuit



These devices have limited built-in ESD protection. The leads should be shorted together or the device placed in conductive foam during storage or handling to prevent electrostatic damage to the MOS gates.

Absolute Maximum Ratings ⁽¹⁾⁽²⁾

Supply Voltage		6.0V	
Storage Temperature		-65°C to +150°C	
ESD Susceptibility ⁽³⁾		2.5kV	
ESD Susceptibility Machine model ⁽⁴⁾		200V	
Junction Temperature (T _J)		150°C	
Soldering Information	DGS0010A Package	Vapor Phase (60 sec.)	215°C
		Infrared (15 sec.)	220°C
Thermal Resistance	θ _{JA} DGS0010A	194°C/W	
	θ _{JC} DGS0010A	52°C/W	
	θ _{JA} NGY0010A ⁽⁵⁾	63°C/W	
	θ _{JC} NGY0010A ⁽⁵⁾	12°C/W	
	θ _{JA} NHD0010A ⁽⁵⁾	63°C/W	
	θ _{JC} NHD0010A ⁽⁵⁾	12°C/W	

- (1) *Absolute Maximum Ratings* indicate limits beyond which damage to the device may occur.
- (2) If Military/Aerospace specified devices are required, please contact the Texas Instruments Sales Office/ Distributors for availability and specifications.
- (3) Human body model, 100pF discharged through a 1.5kΩ resistor.
- (4) Machine Model ESD test is covered by specification EIAJ IC-121-1981. A 200pF cap is charged to the specified voltage, then discharged directly into the IC with no external series resistor (resistance of discharge path must be under 50 Ohms).
- (5) The NGY0010A or NHD0010A package has its Exposed-DAP soldered to an exposed 2in² area of 1oz printed circuit board copper.

Operating Ratings

Temperature Range	T _{MIN} ≤ T _A ≤ T _{MAX}	-40°C ≤ T _A ≤ 85°C
Supply Voltage		2.0V ≤ V _{CC} ≤ 5.5V

Electrical Characteristics ⁽¹⁾⁽²⁾

The following specifications apply for V_{DD} = 5V unless otherwise specified, limits apply to T_A = 25°C.

Parameter	Test Conditions	LM4811		Units (Limits)
		Typ ⁽³⁾	Limit ⁽⁴⁾	
V _{DD}	Supply Voltage		2.0 5.5	V (min) V (max)
I _{DD}	Supply Current V _{IN} = 0V, I _O = 0A	1.3	3.0	mA
I _{SD}	Shutdown Current V _{IN} = 0V	0.3		μA
V _{OS}	Output Offset Voltage V _{IN} = 0V	4.0	50	mV
P _O	Output Power 0.1% THD+N; f = 1kHz			
		R _L = 16Ω	105	mW
		R _L = 32Ω	70	mW
THD+N	Total Harmonic Distortion P _O = 50mW, R _L = 32Ω f = 20Hz to 20kHz	0.3		%
Crosstalk	Channel Separation R _L = 32Ω; f = 1kHz; P _O = 70mW	100		dB
PSRR	Power Supply Rejection Ratio C _B = 1.0μF, V _{RIPPLE} = 100mV _{PP} f = 217Hz	60		dB
V _{IH}	(CLOCK, UP/DN, SHUTDOWN) Input Voltage High		1.4	V (min)

- (1) *Absolute Maximum Ratings* indicate limits beyond which damage to the device may occur.
- (2) All voltages are measured with respect to the ground pin, unless otherwise specified.
- (3) Typical specifications are specified at +25°C and represent the most likely parametric norm.
- (4) Tested limits are ensured to TI's AOQL (Average Outgoing Quality Level). Datasheet min/max specification limits are ensured by design, test, or statistical analysis.

Electrical Characteristics ⁽¹⁾⁽²⁾ (continued)

The following specifications apply for $V_{DD} = 5V$ unless otherwise specified, limits apply to $T_A = 25^\circ C$.

Parameter		Test Conditions	LM4811		Units (Limits)
			Typ ⁽³⁾	Limit ⁽⁴⁾	
V_{IL}	(CLOCK, UP/DN, SHUTDOWN) Input Voltage Low			0.4	V (max)
	Digital Volume Range	Input referred minimum gain	-33		dB
		Input referred maximum gain	+12		dB
	Digital Volume Stepsize	All 16 discrete steps	3.0		dB
	Stepsize Error	All 16 discrete steps	± 0.3		dB
	Channel-to-Channel Volume Tracking Error	All gain settings from -33dB to +12dB	0.15		dB
	Shutdown Attenuation	Shutdown mode active	-100		dB

Electrical Characteristics ⁽¹⁾⁽²⁾

The following specifications apply for $V_{DD} = 3.3V$ unless otherwise specified, limits apply to $T_A = 25^\circ C$.

Parameter		Test Conditions	LM4811		Units (Limits)
			Typ ⁽³⁾	Limit ⁽⁴⁾	
I_{DD}	Supply Current	$V_{IN} = 0V, I_O = 0A$	1.1		mA
I_{SD}	Shutdown Current	$V_{IN} = 0V$	0.3		μA
V_{OS}	Output Offset Voltage	$V_{IN} = 0V$	4.0		mV
P_o	Output Power	0.1% THD+N; $f = 1kHz$			
		$R_L = 16\Omega$	40		mW
		$R_L = 32\Omega$	28		mW
THD+N	Total Harmonic Distortion	$P_O = 25mW, R_L = 32\Omega$ $f = 20Hz$ to $20kHz$	0.5		%
PSRR	Power Supply Rejection Ratio	$C_B = 1.0\mu F, V_{RIPPLE} = 100mV_{PP}$ $f = 217Hz$	60		dB
V_{IH}	(CLOCK, UP/DN, SHUTDOWN) Input Voltage High		1.4		V (min)
V_{IL}	(CLOCK, UP/DN, SHUTDOWN) Input Voltage Low		0.4		V (max)
	Digital Volume Range	Input referred minimum gain	-33		dB
		Input referred maximum gain	+12		dB
	Digital Volume Stepsize	All 16 discrete steps	3.0		dB
	Stepsize Error	All 16 discrete steps	± 0.3		dB
	Channel-to-Channel Volume Tracking Error	All gain settings from -33dB to +12dB	0.15		dB
	Shutdown Attenuation	Shutdown mode active	-100		dB

- (1) *Absolute Maximum Ratings* indicate limits beyond which damage to the device may occur.
- (2) All voltages are measured with respect to the ground pin, unless otherwise specified.
- (3) Typical specifications are specified at $+25^\circ C$ and represent the most likely parametric norm.
- (4) Tested limits are ensured to TI's AOQL (Average Outgoing Quality Level). Datasheet min/max specification limits are ensured by design, test, or statistical analysis.

Electrical Characteristics ⁽¹⁾⁽²⁾

The following specifications apply for $V_{DD} = 2.6V$ unless otherwise specified, limits apply to $T_A = 25^\circ C$.

Parameter		Test Conditions	LM4811		Units (Limits)
			Typ ⁽³⁾	Limit ⁽⁴⁾	
I_{DD}	Supply Current	$V_{IN} = 0V, I_O = 0A$	1.0		mA
I_{SD}	Shutdown Current	$V_{IN} = 0V$	0.3		μA
V_{OS}	Output Offset Voltage	$V_{IN} = 0V$	4.0		mV
P_o	Output Power	0.1% THD+N; $f = 1kHz$			
		$R_L = 16\Omega$	20		mW
		$R_L = 32\Omega$	16		mW
THD+N	Total Harmonic Distortion	$P_O = 15mW, R_L = 32\Omega$ $f = 20Hz$ to $20kHz$	0.6		%
PSRR	Power Supply Rejection Ratio	$C_B = 1.0\mu F, V_{RIPPLE} = 100mV_{PP}$ $f = 217Hz$	60		dB
V_{IH}	(CLOCK, UP/DN, SHUTDOWN) Input Voltage High		1.4		V (min)
V_{IL}	(CLOCK, UP/DN, SHUTDOWN) Input Voltage Low		0.4		V (max)
	Digital Volume Range	Input referred minimum gain	-33		dB
		Input referred maximum gain	+12		dB
	Digital Volume Stepsize	All 16 discrete steps	3.0		dB
	Stepsize Error	All 16 discrete steps	± 0.3		dB
	Channel-to-Channel Volume Tracking Error	All gain settings from -33dB to +12dB	0.15		dB
	Shutdown Attenuation	Shutdown mode active	-75		dB

- (1) *Absolute Maximum Ratings* indicate limits beyond which damage to the device may occur.
- (2) All voltages are measured with respect to the ground pin, unless otherwise specified.
- (3) Typical specifications are specified at $+25^\circ C$ and represent the most likely parametric norm.
- (4) Tested limits are ensured to TI's AOQL (Average Outgoing Quality Level). Datasheet min/max specification limits are ensured by design, test, or statistical analysis.

External Components Description

Components	Functional Description (See Figure 4)
1. C_i	This is the input coupling capacitor. It blocks the DC voltage at, and couples the input signal to, the amplifier's input terminals. C_i also creates a highpass filter with the internal input resistor, R_i , at $f_c = 1/(2\pi R_i C_i)$. The minimum value of R_i is $33k\Omega$. Refer to PROPER SELECTION OF EXTERNAL COMPONENTS for an explanation of how to determine the value of C_i .
2. C_S	This is the supply bypass capacitor. It provides power supply filtering. Refer to Application Information for proper placement and selection of the supply bypass capacitor.
3. C_B	This is the BYPASS pin capacitor. It provides half-supply filtering. Refer to PROPER SELECTION OF EXTERNAL COMPONENTS for information concerning proper placement and selection of C_B .
4. C_O	This is the output coupling capacitor. It blocks the DC voltage at the amplifier's output and it forms a high pass filter with R_L at $f_o = 1/(2\pi R_L C_O)$

Typical Performance Characteristics

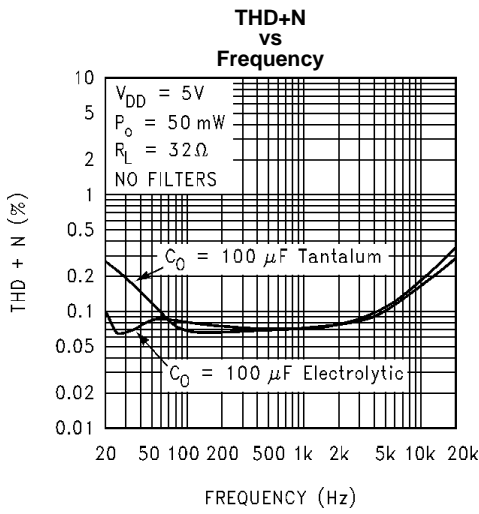

Figure 5.

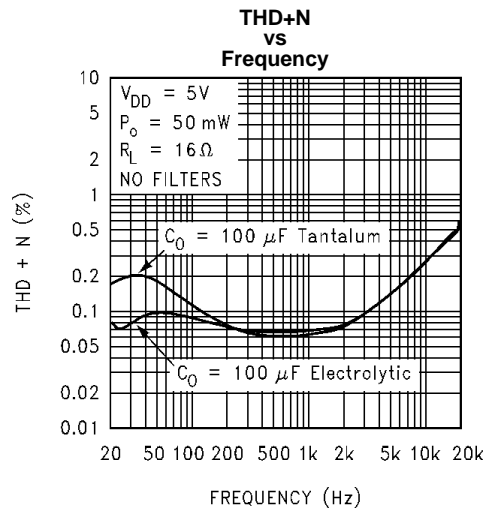

Figure 6.

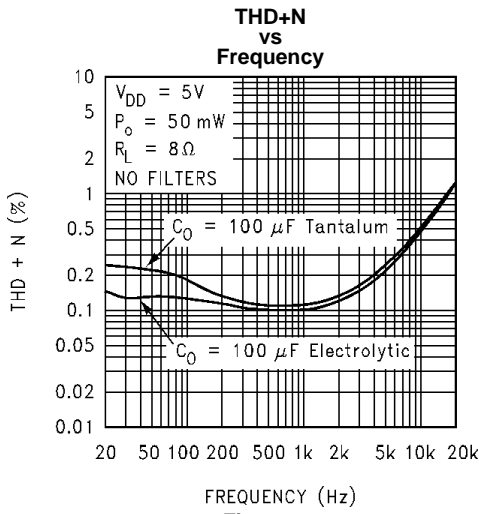

Figure 7.

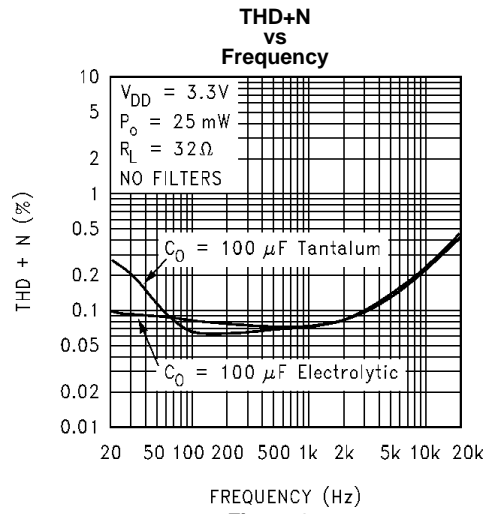

Figure 8.

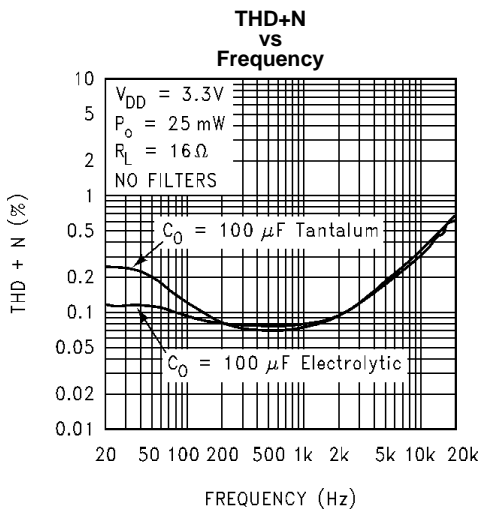

Figure 9.

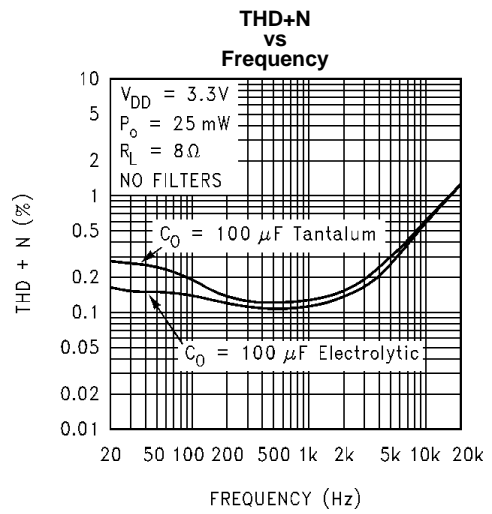

Figure 10.

Typical Performance Characteristics (continued)

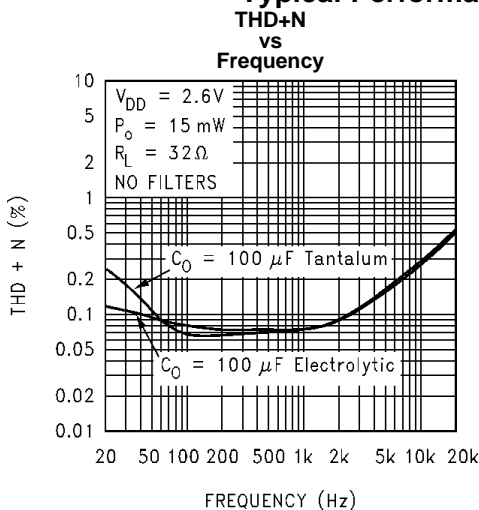

Figure 11.

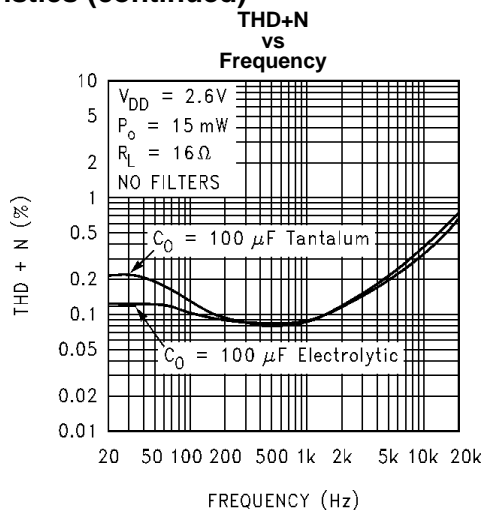

Figure 12.

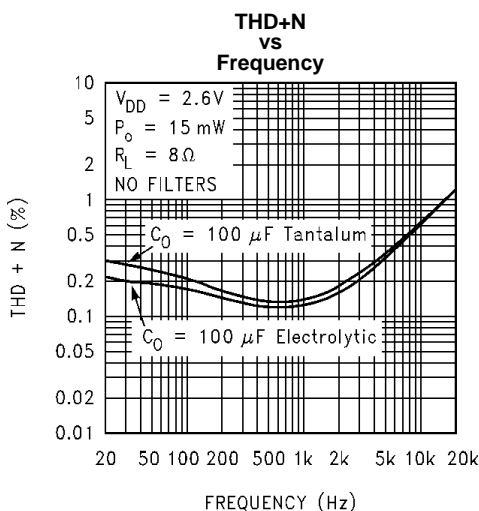

Figure 13.

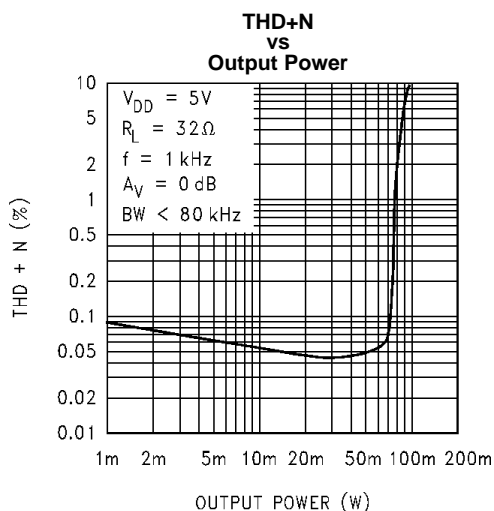

Figure 14.

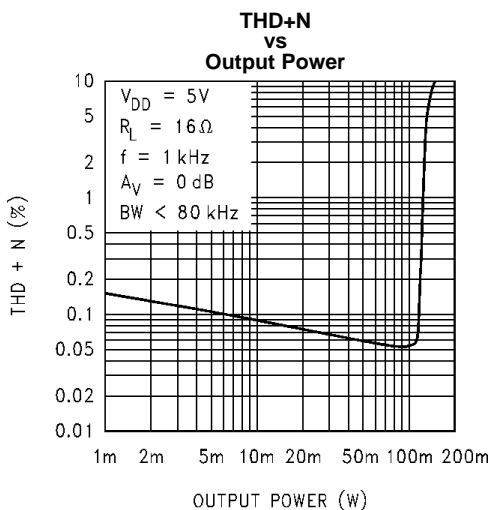

Figure 15.

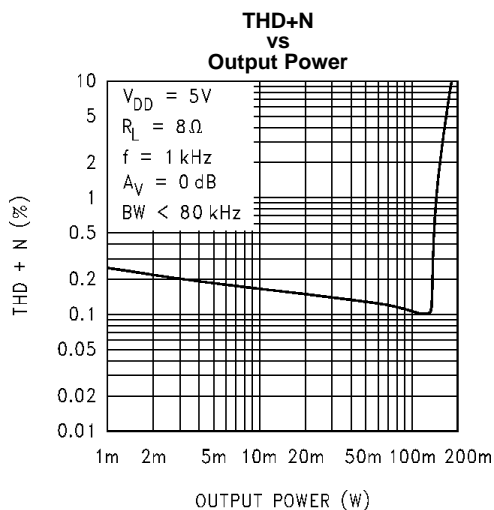

Figure 16.

Typical Performance Characteristics (continued)

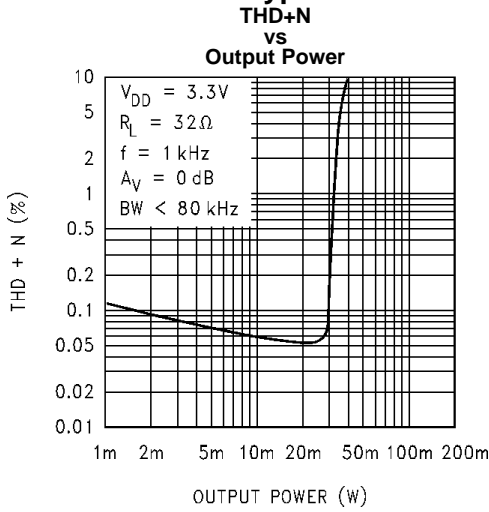

Figure 17.

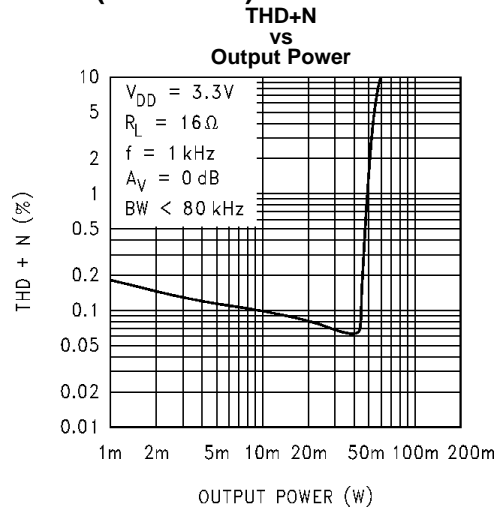

Figure 18.

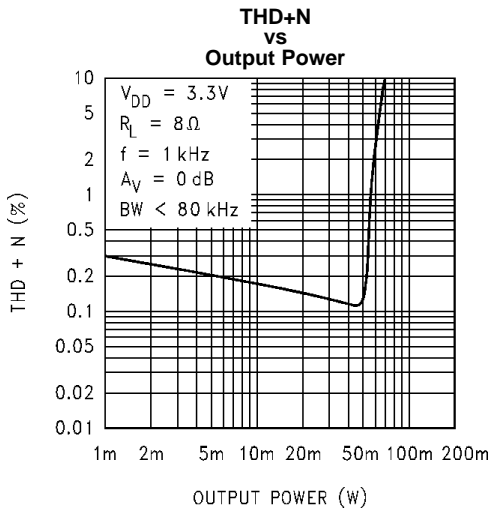

Figure 19.

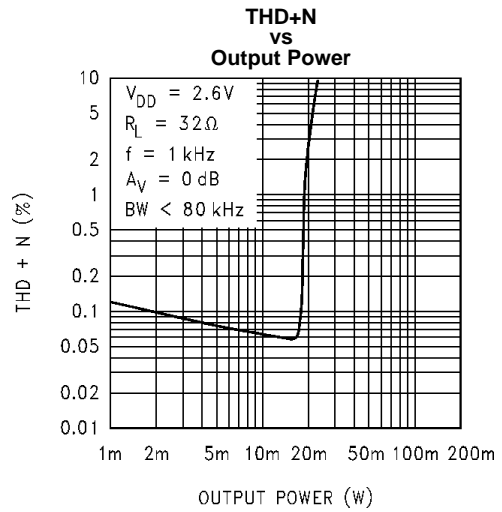

Figure 20.

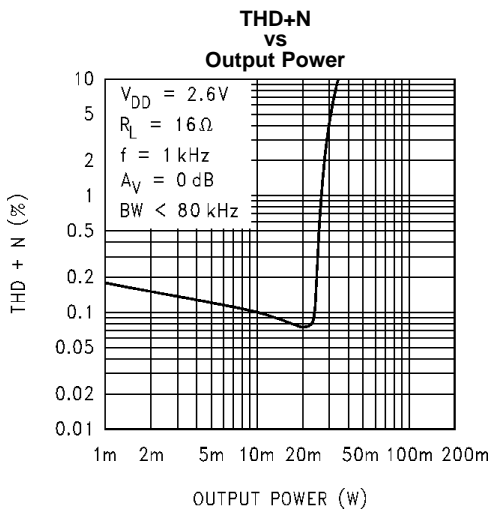

Figure 21.

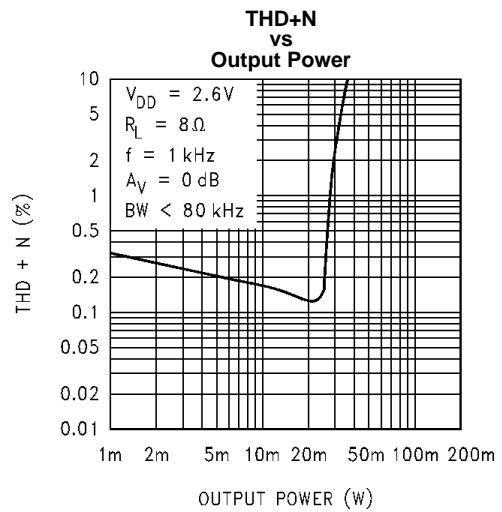
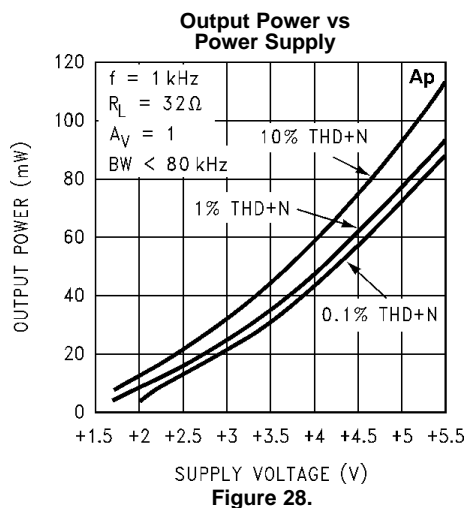
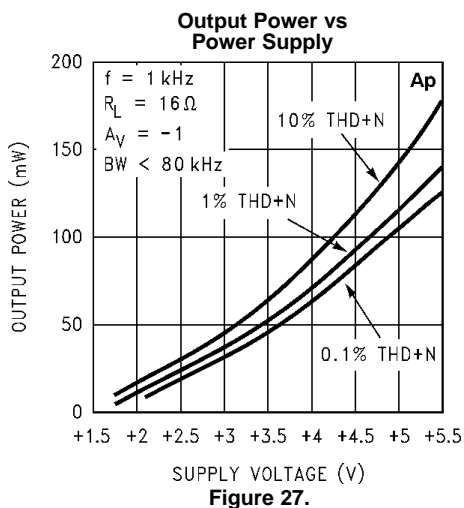
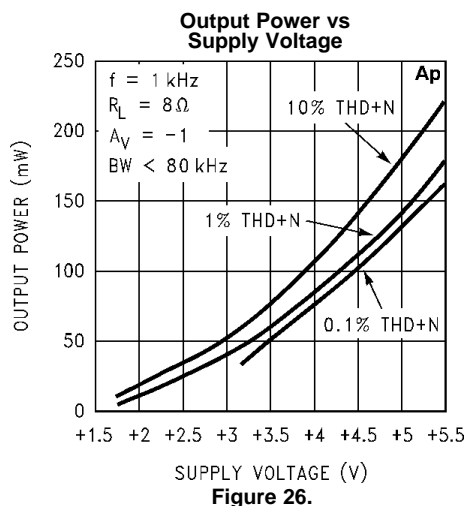
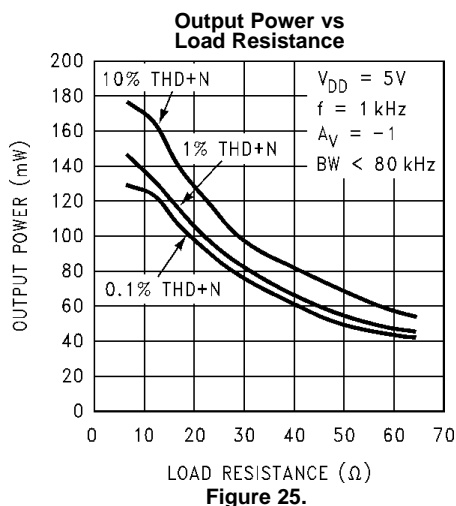
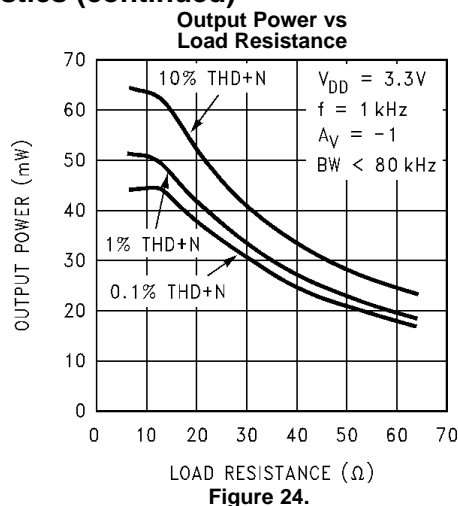
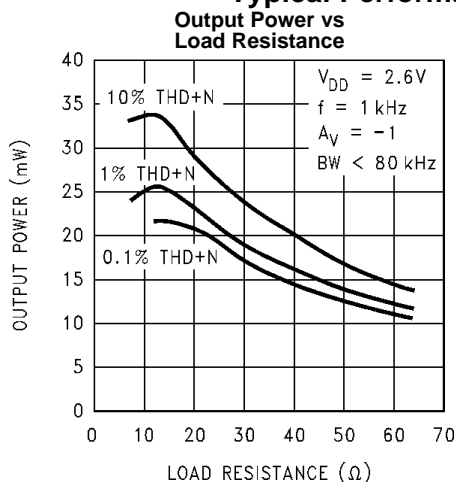

Figure 22.

Typical Performance Characteristics (continued)



Typical Performance Characteristics (continued)

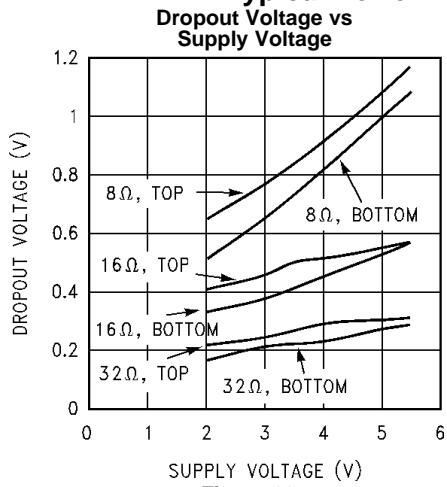

Figure 29.

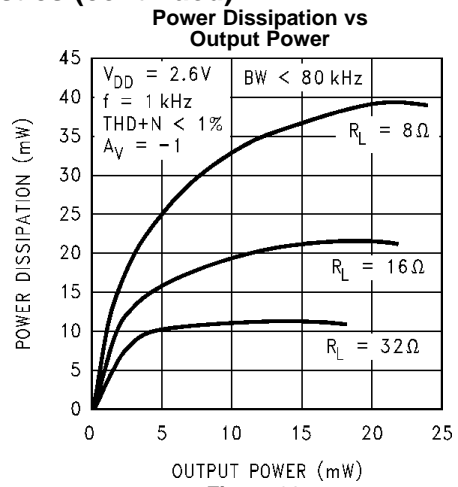

Figure 30.

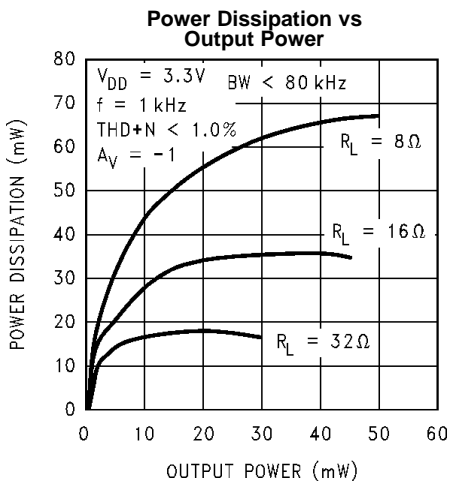

Figure 31.

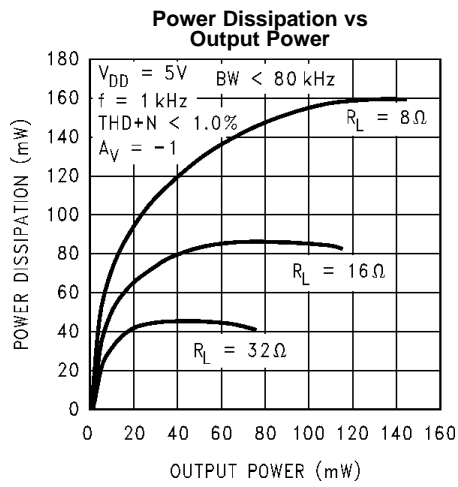

Figure 32.

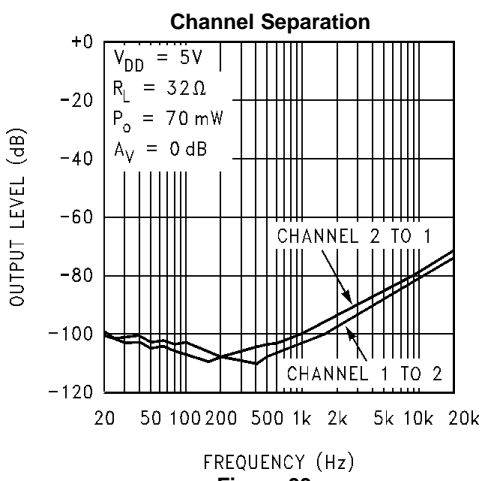

Figure 33.

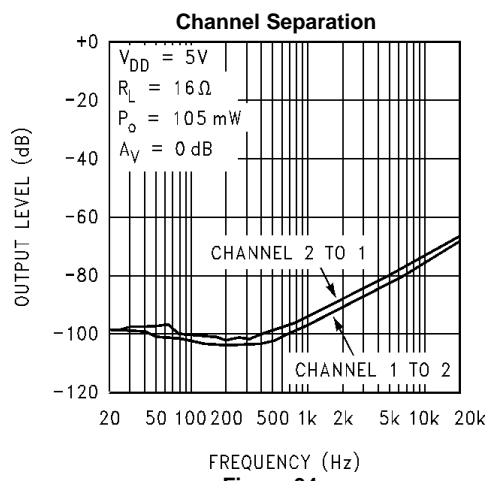

Figure 34.

Typical Performance Characteristics (continued)

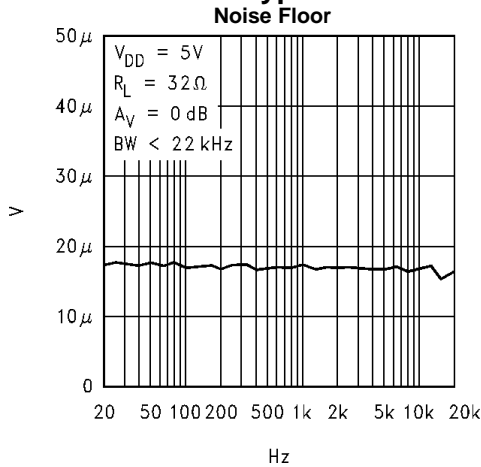

Figure 35.

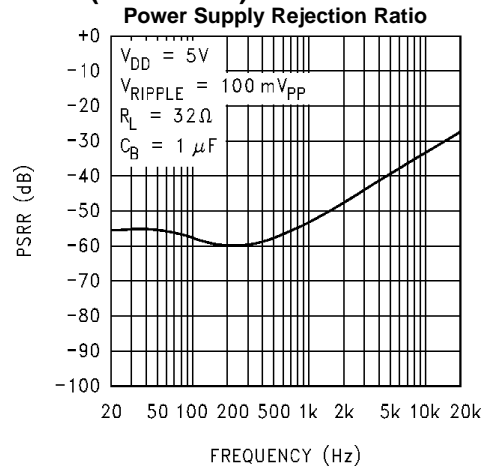

Figure 36.

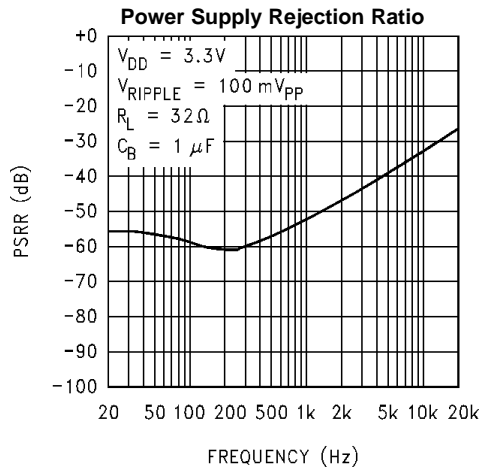

Figure 37.

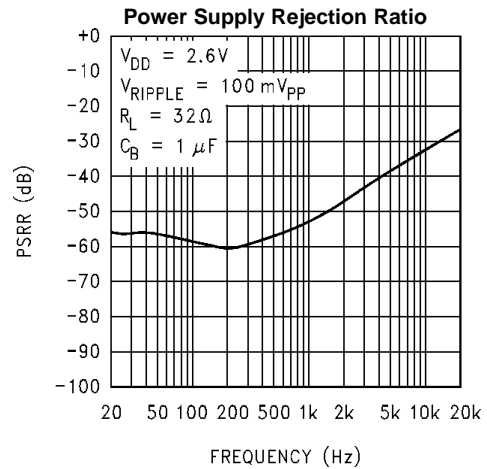

Figure 38.

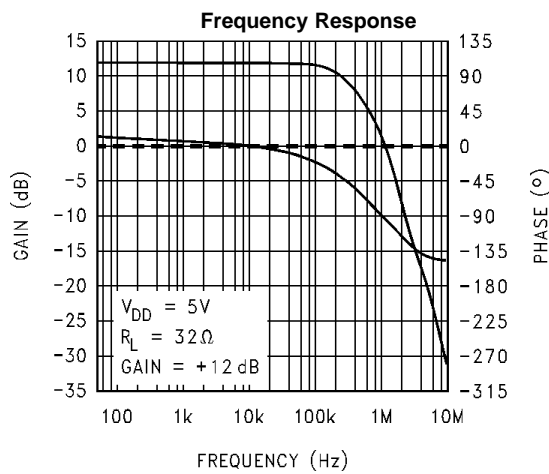

Figure 39.

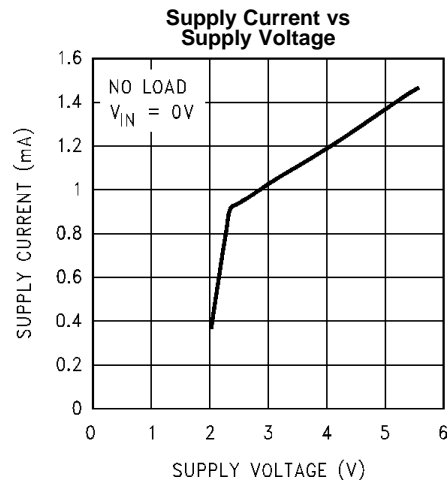

Figure 40.

APPLICATION INFORMATION

DIGITAL VOLUME CONTROL

The LM4811's gain is controlled by the signals applied to the CLOCK and UP/DN inputs. An external clock is required to drive the CLOCK pin. At each rising edge of the clock signal, the gain will either increase or decrease by a 3dB step depending on the logic voltage level applied to the UP/DN pin. A logic high voltage level applied to the UP/DN pin causes the gain to increase by 3dB at each rising edge of the clock signal. Conversely, a logic low voltage level applied to the UP/DN pin causes the gain to decrease 3dB at each rising edge of the clock signal. For both the CLOCK and UP/DN inputs, the trigger point is 1.4V minimum for a logic high level, and 0.4V maximum for a logic low level.

There are 16 discrete gain settings ranging from +12dB maximum to –33dB minimum. Upon device power on, the amplifier's gain is set to a default value of 0dB. However, when coming out of shutdown mode, the LM4811 will revert back to its previous gain setting.

The LM4811's CLOCK and UP/DN pins should be debounced in order to avoid unwanted state changes during transitions between V_{IL} and V_{IH} . This will ensure correct operation of the digital volume control. A microcontroller or microprocessor output is recommended to drive the CLOCK and UP/DN pins.

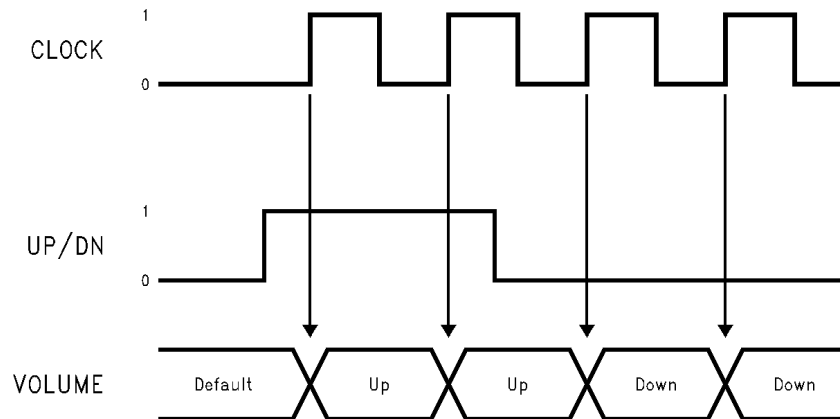

Figure 41. Timing Diagram

POWER DISSIPATION

Power dissipation is a major concern when using any power amplifier and must be thoroughly understood to ensure a successful design. [Equation 1](#) states the maximum power dissipation point for a single-ended amplifier operating at a given supply voltage and driving a specified output load.

$$P_{DMAX} = (V_{DD})^2 / (2\pi^2 R_L) \quad (1)$$

Since the LM4811 has two operational amplifiers in one package, the maximum internal power dissipation point is twice that of the number which results from [Equation 1](#). Even with the large internal power dissipation, the LM4811 does not require heat sinking over a large range of ambient temperature. From [Equation 1](#), assuming a 5V power supply and a 32Ω load, the maximum power dissipation point is 40mW per amplifier. Thus the maximum package dissipation point is 80mW. The maximum power dissipation point obtained must not be greater than the power dissipation predicted by [Equation 2](#):

$$P_{DMAX} = (T_{JMAX} - T_A) / \theta_{JA} \quad (2)$$

For the VSSOP package, $\theta_{JA} = 194^{\circ}\text{C/W}$, and for the WSON/SON package, $\theta_{JA} = 63^{\circ}\text{C/W}$. $T_{JMAX} = 150^{\circ}\text{C}$ for the LM4811. For a given ambient temperature, T_A , of the system surroundings, [Equation 1](#) can be used to find the maximum internal power dissipation supported by the IC packaging. If the result of [Equation 1](#) is greater than that of [Equation 2](#), then either the supply voltage must be decreased, the load impedance increased, or T_A reduced. For the VSSOP package in a typical application of a 5V power supply and a 32 Ω load, the maximum ambient temperature possible without violating the maximum junction temperature is approximately 134.5 $^{\circ}\text{C}$. This assumes the device operates at maximum power dissipation and uses surface mount packaging. Internal power dissipation is a function of output power. If typical operation is not around the maximum power dissipation point, operation at higher ambient temperatures is possible. Refer to [Typical Performance Characteristics](#) for power dissipation information for lower output power levels.

EXPOSED-DAP PACKAGE PCB MOUNTING CONSIDERATION

The LM4811's exposed-dap (die attach paddle) package (WSON/SON) provides a low thermal resistance between the die and the PCB to which the part is mounted and soldered. This allows rapid heat transfer from the die to the surrounding PCB copper traces, ground plane, and surrounding air.

The WSON/SON package should have its DAP soldered to a copper pad on the PCB. The DAP's PCB copper pad may be connected to a large plane of continuous unbroken copper. This plane forms a thermal mass, heat sink, and radiation area.

However, since the LM4811 is designed for headphone applications, connecting a copper plane to the DAP's PCB copper pad is not required. [Figure 32](#) in [Typical Performance Characteristics](#) shows that the maximum power dissipated is just 45mW per amplifier with a 5V power supply and a 32 Ω load.

Further detailed and specific information concerning PCB layout, fabrication, and mounting an WSON/SON package is available from Texas Instruments' Package Engineering Group under application note AN1187.

POWER SUPPLY BYPASSING

As with any power amplifier, proper supply bypassing is critical for low noise performance and high power supply rejection. The capacitor location on both the bypass and power supply pins should be as close to the device as possible. The value of the bypass capacitor directly affects the LM4811's half-supply voltage stability and PSRR. The stability and supply rejection increase as the bypass capacitor's value increases. Typical applications employ a 5V regulator with 10 μF and a 0.1 μF bypass capacitors which aid in supply stability, but do not eliminate the need for bypassing the supply nodes of the LM4811. The selection of bypass capacitors, especially C_B , is thus dependent upon desired low frequency PSRR, click and pop performance, (explained in [PROPER SELECTION OF EXTERNAL COMPONENTS](#)), system cost, and size constraints.

SHUTDOWN FUNCTION

In order to reduce power consumption while not in use, the LM4811 features amplifier bias circuitry shutdown. This shutdown function is activated by applying a logic high to the SHUTDOWN pin. The trigger point is 1.4V minimum for a logic high level, and 0.4V maximum for a logic low level. It is best to switch between ground and V_{DD} to ensure optimal shutdown operation. By switching the SHUTDOWN pin to V_{DD} , the LM4811 supply current draw will be minimized in idle mode. Whereas the device will be disabled with shutdown voltages less than V_{DD} , the idle current may be greater than the typical value of 0.3 μA . In either case, the SHUTDOWN pin should be tied to a fixed voltage to avoid unwanted state changes.

In many applications, a microcontroller or microprocessor output is used to control the shutdown circuitry. This provides a quick, smooth shutdown transition. Another solution is to use a single-pole, single-throw switch in conjunction with an external pull-up resistor. When the switch is closed, the SHUTDOWN pin is connected to ground and enables the amplifier. If the switch is open, the external pull-up resistor, R_{PU} , will disable the LM4811. This scheme ensures that the SHUTDOWN pin will not float, thus preventing unwanted state changes.

PROPER SELECTION OF EXTERNAL COMPONENTS

Selection of external components when using integrated power amplifiers is critical for optimum device and system performance. While the LM4811 is tolerant of external component combinations, consideration must be given to the external component values that maximize overall system quality.

The LM4811's unity-gain stability allows a designer to maximize system performance. Low gain settings maximize signal-to-noise performance and minimizes THD+N. Low gain configurations require large input signals to obtain a given output power. Input signals equal to or greater than 1 V_{rms} are available from sources such as audio codecs. Please refer to [AUDIO POWER AMPLIFIER DESIGN](#) for a more complete explanation of proper gain selection.

Selection of Input and Output Capacitor Size

Besides gain, one of the major considerations is the closed loop bandwidth of the amplifier. To a large extent, the bandwidth is dictated by the choice of external components shown in [Figure 4](#). Both the input coupling capacitor, C_i, and the output coupling capacitor, C_o, form first order high pass filters which limit low frequency response. These values should be based on the desired frequency response weighed against the following:

Large value input and output capacitors are both expensive and space consuming for portable designs. Clearly a certain sized capacitor is needed to couple in low frequencies without severe attenuation. But in many cases the speakers used in portable systems, whether internal or external, have little ability to reproduce signals below 150Hz. Thus large input and output capacitors may not increase system performance.

In addition to system cost and size, click and pop performance is affected by the size of the input coupling capacitor, C_i. A larger input coupling capacitor requires more charge to reach its quiescent DC voltage (nominally 1/2 V_{DD}). This charge comes from the output via the feedback and is apt to create pops upon device enable. Turn on pops can be minimized by reducing C_i value based on necessary low frequency response.

Besides minimizing the input and output capacitor values, careful consideration should be paid to the bypass capacitor value. Bypass capacitor C_B is the most critical component to minimize turn on pops since it determines how fast the LM4811 turns on. The slower the LM4811's outputs ramp to their quiescent DC voltage (nominally 1/2 V_{DD}), the smaller the turn on pop. While the device will function properly, (no oscillations or motorboating), with C_B equal to 1μF, the device will be much more susceptible to turn on clicks and pops. Thus, a value of C_B equal to 1μF or larger is recommended in all but the most cost sensitive designs.

Also, careful consideration must be taken in selecting a certain type of capacitor to be used in the system. Different types of capacitors (tantalum, electrolytic, ceramic) have unique performance characteristics and may affect overall system performance.

AUDIO POWER AMPLIFIER DESIGN

Design a Dual 70mW/32Ω Audio Amplifier

Given:	
Power Output	70mW
Load Impedance	32Ω
Input Level	1Vrms (max)
Input Impedance	33kΩ (min)
Bandwidth	100 Hz–20 kHz ± 0.50dB

A designer must first determine the minimum supply rail to obtain the specified output power. By extrapolating from [Figure 26](#) in [Typical Performance Characteristics](#), the supply rail can be easily found. A second way to determine the minimum supply rail is to calculate the required V_{OPEAK} using [Equation 3](#) and add the dropout voltage. For a single-ended application, the minimum supply voltage can be approximated by (2V_{OPEAK} + (V_{ODTOP} + V_{ODBOT})), where V_{ODBOT} and V_{ODTOP} are extrapolated from [Figure 29](#) in [Typical Performance Characteristics](#).

$$V_{\text{opeak}} = \sqrt{2R_L P_O} \quad (3)$$

Using [Figure 28](#) for a 32Ω load, the minimum supply rail is 4.8V. Since 5V is a standard supply voltage in most applications, it is chosen for the supply rail. Extra supply voltage creates headroom that allows the LM4811 to reproduce peaks in excess of 70mW without clipping the signal. At this time, the designer must make sure that the power supply choice along with the output impedance does not violate the conditions explained in [POWER DISSIPATION](#). Remember that the maximum power dissipation point from [Equation 1](#) must be multiplied by two since there are two independent amplifiers inside the package.

The final design step is to address the bandwidth requirements which must be stated as a pair of –3dB frequency points. Five times away from a –3dB point is 0.17dB down from passband response assuming a single pole roll-off. As stated in [External Components Description](#), C_i and C_o create first order highpass filters. Thus to obtain the desired frequency low response of 100Hz within ±0.5dB, both poles must be taken into consideration. The combination of two single order filters at the same frequency forms a second order response. This results in a signal which is down 0.34dB at five times away from the single order filter –3dB point. Thus, a frequency of 20Hz is used in the following equations to ensure that the response is better than 0.5dB down at 100Hz.

$$C_i \geq 1 / (2\pi * 33 \text{ k}\Omega * 20 \text{ Hz}) = 0.241\mu\text{F}; \text{ use } 0.39\mu\text{F}. \quad (4)$$

$$C_o \geq 1 / (2\pi * 32\Omega * 20 \text{ Hz}) = 249\mu\text{F}; \text{ use } 330\mu\text{F}. \quad (5)$$

The high frequency pole is determined by the product of the desired high frequency pole, f_H, and the closed-loop gain, A_v. With a closed-loop gain of 3.98 or +12dB and f_H = 100kHz, the resulting GBWP = 398kHz which is much smaller than the LM4811 GBWP of 1MHz. This figure displays that at the maximum gain setting of 3.98 or +12dB, the LM4811 can be used without running into bandwidth limitations.

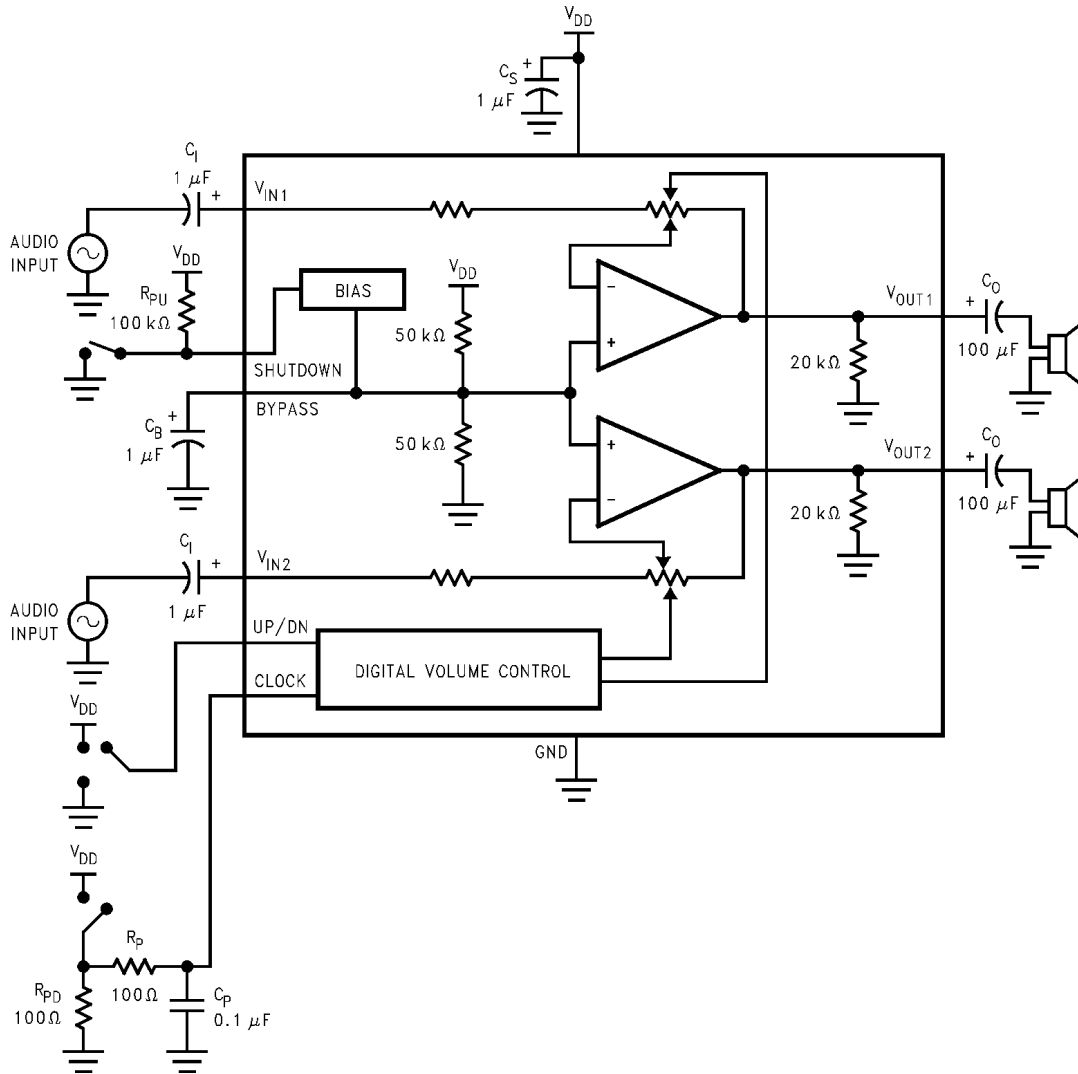

Figure 42. Demo Board Schematic

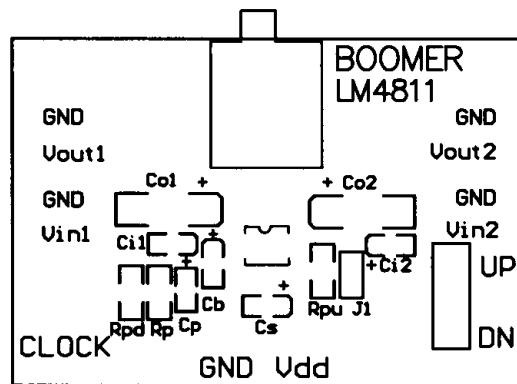

Figure 43. Recommended VSSOP PC Board Layout: TOP Silk Screen

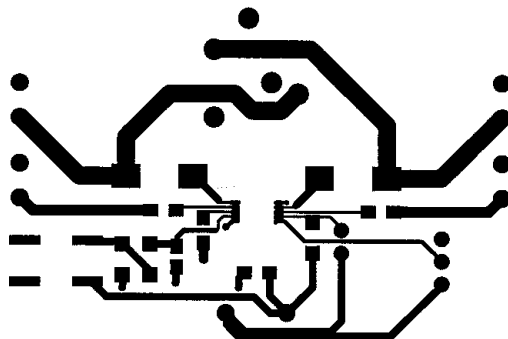

Figure 44. Recommended VSSOP PC Board Layout:
TOP Top Layer

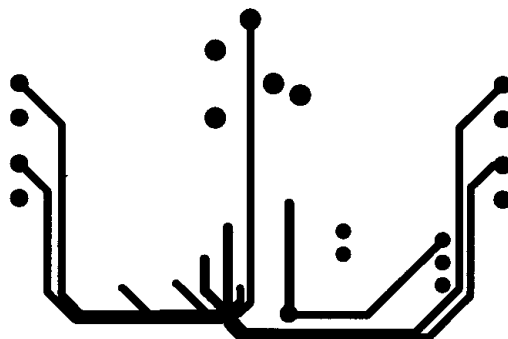

Figure 45. Recommended VSSOP PC Board Layout:
Bottom Layer

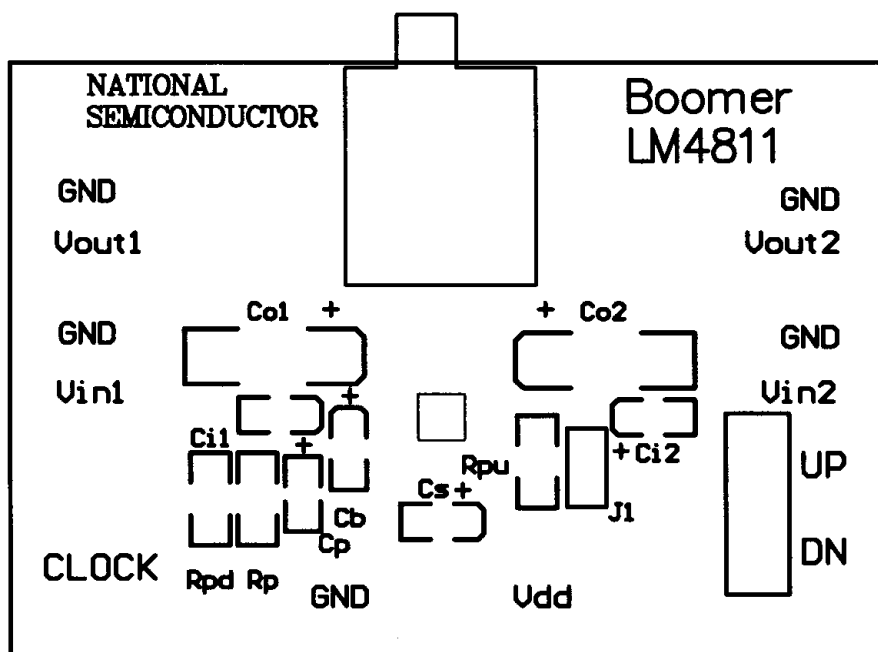

Figure 46. Recommended WSON/SOP PC Board Layout:
TOP Silk Screen

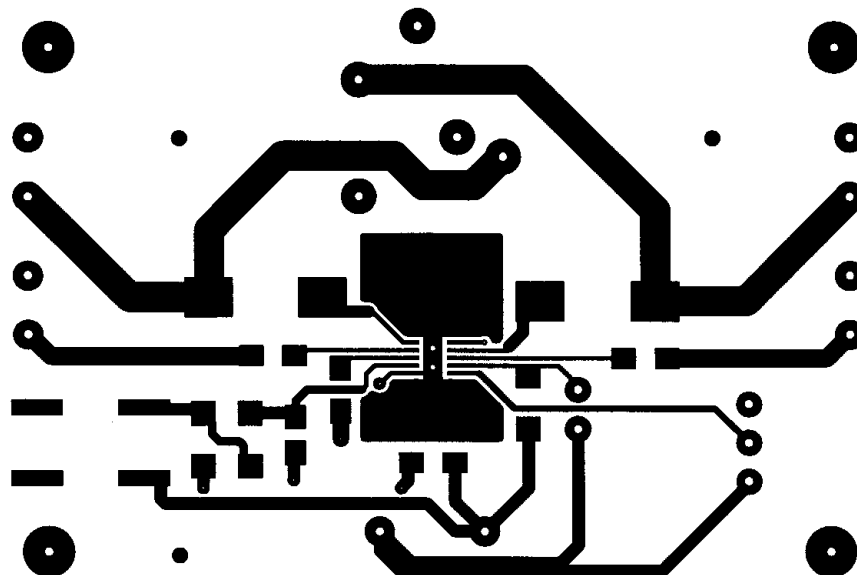

Figure 47. Recommended WSON/SOP PC Board Layout:
TOP Top Layer

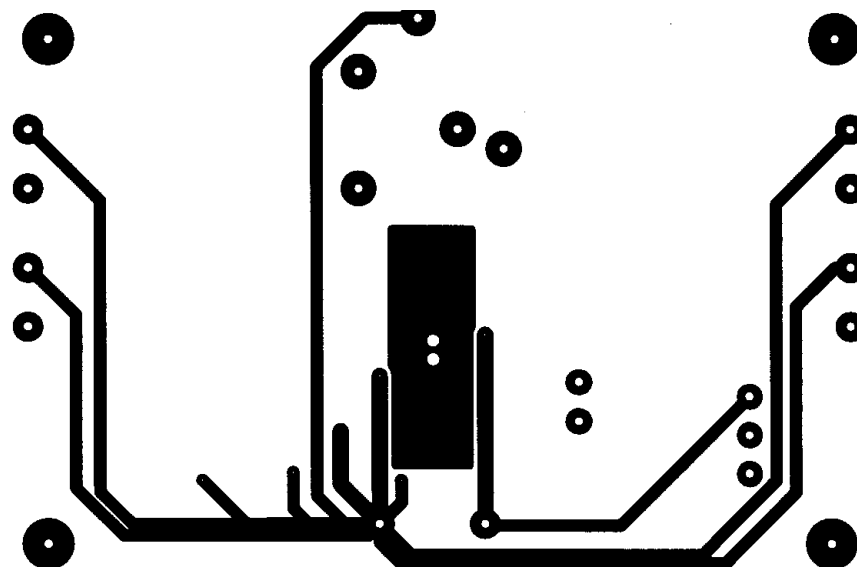

Figure 48. Recommended WSON/SOP PC Board Layout:
Bottom Layer

REVISION HISTORY

Rev	Date	Description
0.1	04/06/06	Added NHD0010A Package and markings, then re-released D/S to the WEB (per Alvin F.).
D	04/05/13	Changed layout of National Data Sheet to TI format.

PACKAGING INFORMATION

Orderable Device	Status (1)	Package Type	Package Drawing	Pins	Package Qty	Eco Plan (2)	Lead finish/ Ball material (6)	MSL Peak Temp (3)	Op Temp (°C)	Device Marking (4/5)	Samples
LM4811MM/NOPB	ACTIVE	VSSOP	DGS	10	1000	RoHS & Green	SN	Level-1-260C-UNLIM	-40 to 85	G11	Samples
LM4811MMX/NOPB	ACTIVE	VSSOP	DGS	10	3500	RoHS & Green	SN	Level-1-260C-UNLIM	-40 to 85	G11	Samples

(1) The marketing status values are defined as follows:

ACTIVE: Product device recommended for new designs.

LIFEBUY: TI has announced that the device will be discontinued, and a lifetime-buy period is in effect.

NRND: Not recommended for new designs. Device is in production to support existing customers, but TI does not recommend using this part in a new design.

PREVIEW: Device has been announced but is not in production. Samples may or may not be available.

OBSOLETE: TI has discontinued the production of the device.

(2) **RoHS:** TI defines "RoHS" to mean semiconductor products that are compliant with the current EU RoHS requirements for all 10 RoHS substances, including the requirement that RoHS substance do not exceed 0.1% by weight in homogeneous materials. Where designed to be soldered at high temperatures, "RoHS" products are suitable for use in specified lead-free processes. TI may reference these types of products as "Pb-Free".

RoHS Exempt: TI defines "RoHS Exempt" to mean products that contain lead but are compliant with EU RoHS pursuant to a specific EU RoHS exemption.

Green: TI defines "Green" to mean the content of Chlorine (Cl) and Bromine (Br) based flame retardants meet JS709B low halogen requirements of <=1000ppm threshold. Antimony trioxide based flame retardants must also meet the <=1000ppm threshold requirement.

(3) MSL, Peak Temp. - The Moisture Sensitivity Level rating according to the JEDEC industry standard classifications, and peak solder temperature.

(4) There may be additional marking, which relates to the logo, the lot trace code information, or the environmental category on the device.

(5) Multiple Device Markings will be inside parentheses. Only one Device Marking contained in parentheses and separated by a "~" will appear on a device. If a line is indented then it is a continuation of the previous line and the two combined represent the entire Device Marking for that device.

(6) Lead finish/Ball material - Orderable Devices may have multiple material finish options. Finish options are separated by a vertical ruled line. Lead finish/Ball material values may wrap to two lines if the finish value exceeds the maximum column width.

Important Information and Disclaimer:The information provided on this page represents TI's knowledge and belief as of the date that it is provided. TI bases its knowledge and belief on information provided by third parties, and makes no representation or warranty as to the accuracy of such information. Efforts are underway to better integrate information from third parties. TI has taken and continues to take reasonable steps to provide representative and accurate information but may not have conducted destructive testing or chemical analysis on incoming materials and chemicals. TI and TI suppliers consider certain information to be proprietary, and thus CAS numbers and other limited information may not be available for release.

In no event shall TI's liability arising out of such information exceed the total purchase price of the TI part(s) at issue in this document sold by TI to Customer on an annual basis.

TAPE AND REEL INFORMATION

QUADRANT ASSIGNMENTS FOR PIN 1 ORIENTATION IN TAPE

*All dimensions are nominal

Device	Package Type	Package Drawing	Pins	SPQ	Reel Diameter (mm)	Reel Width W1 (mm)	A0 (mm)	B0 (mm)	K0 (mm)	P1 (mm)	W (mm)	Pin1 Quadrant
LM4811MM/NOPB	VSSOP	DGS	10	1000	178.0	12.4	5.3	3.4	1.4	8.0	12.0	Q1
LM4811MMX/NOPB	VSSOP	DGS	10	3500	330.0	12.4	5.3	3.4	1.4	8.0	12.0	Q1

TAPE AND REEL BOX DIMENSIONS

*All dimensions are nominal

Device	Package Type	Package Drawing	Pins	SPQ	Length (mm)	Width (mm)	Height (mm)
LM4811MM/NOPB	VSSOP	DGS	10	1000	208.0	191.0	35.0
LM4811MMX/NOPB	VSSOP	DGS	10	3500	367.0	367.0	35.0

DGS0010A



PACKAGE OUTLINE

VSSOP - 1.1 mm max height

SMALL OUTLINE PACKAGE

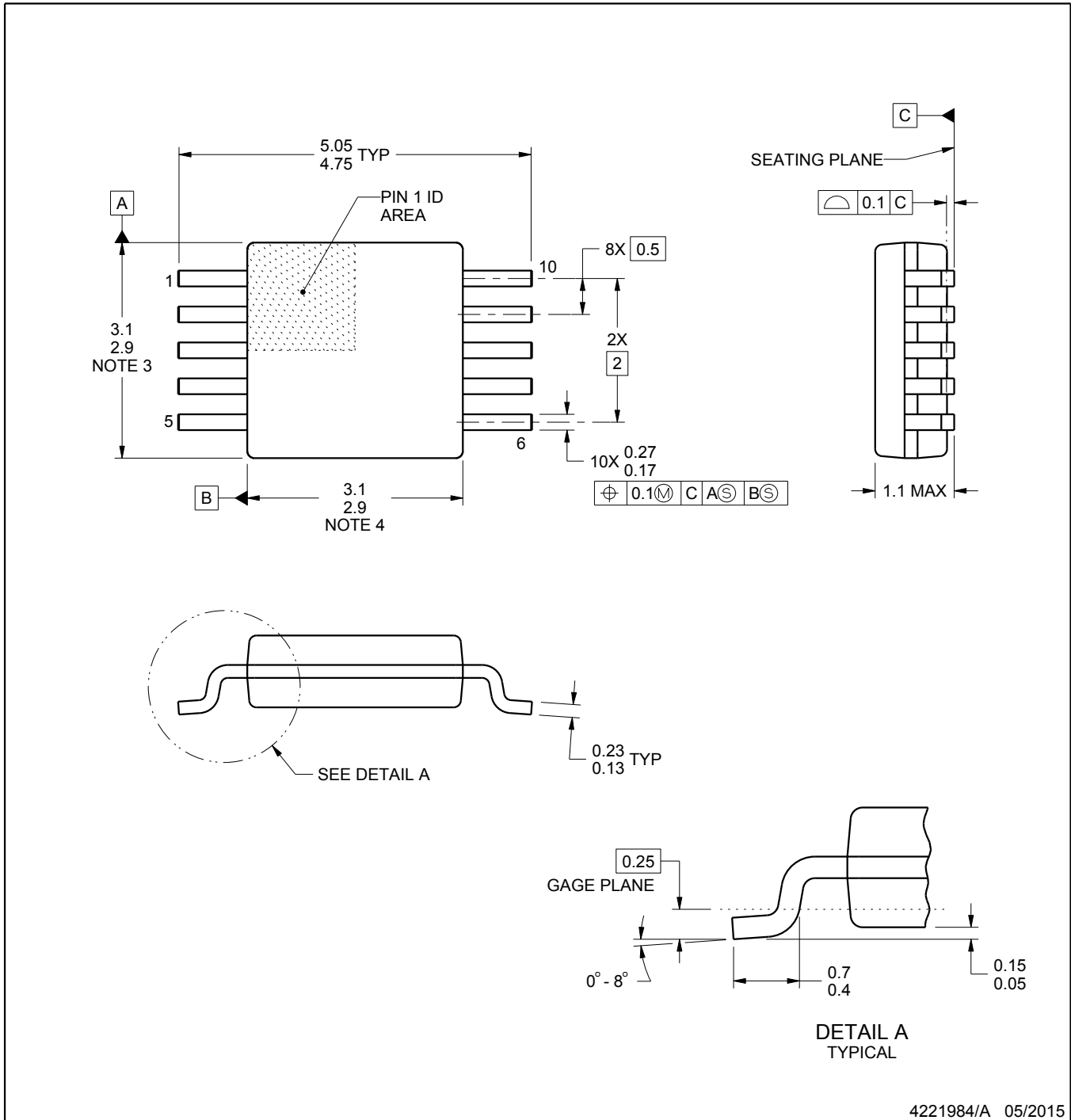

4221984/A 05/2015

NOTES:

1. All linear dimensions are in millimeters. Any dimensions in parenthesis are for reference only. Dimensioning and tolerancing per ASME Y14.5M.
2. This drawing is subject to change without notice.
3. This dimension does not include mold flash, protrusions, or gate burrs. Mold flash, protrusions, or gate burrs shall not exceed 0.15 mm per side.
4. This dimension does not include interlead flash. Interlead flash shall not exceed 0.25 mm per side.
5. Reference JEDEC registration MO-187, variation BA.

EXAMPLE BOARD LAYOUT

DGS0010A

VSSOP - 1.1 mm max height

SMALL OUTLINE PACKAGE

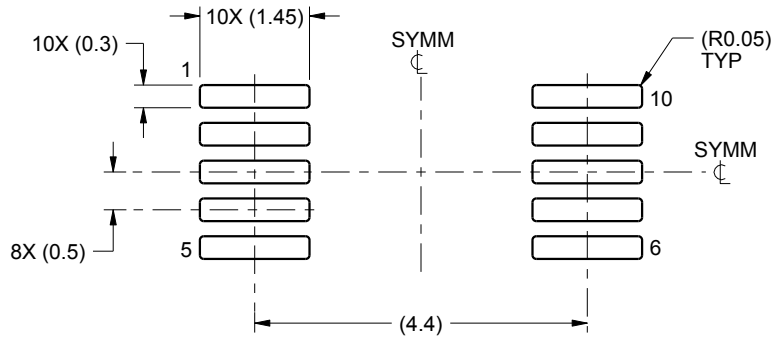

LAND PATTERN EXAMPLE
SCALE:10X

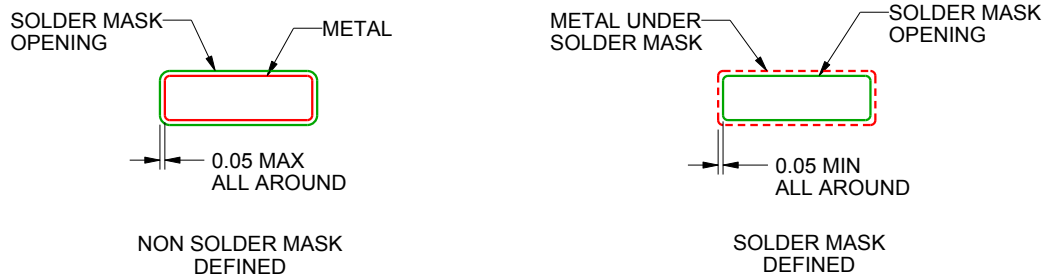

SOLDER MASK DETAILS
NOT TO SCALE

4221984/A 05/2015

NOTES: (continued)

- 6. Publication IPC-7351 may have alternate designs.
- 7. Solder mask tolerances between and around signal pads can vary based on board fabrication site.

EXAMPLE STENCIL DESIGN

DGS0010A

VSSOP - 1.1 mm max height

SMALL OUTLINE PACKAGE

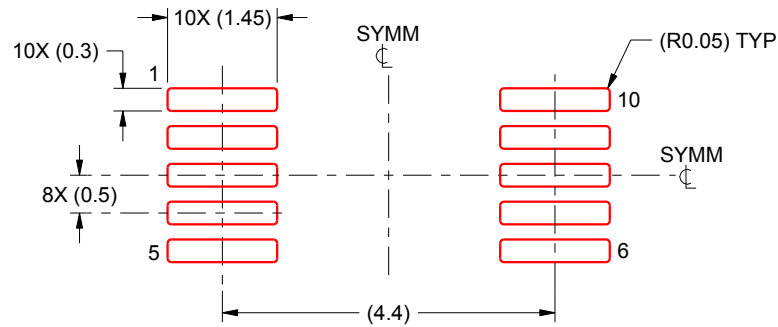

SOLDER PASTE EXAMPLE
BASED ON 0.125 mm THICK STENCIL
SCALE:10X

4221984/A 05/2015

NOTES: (continued)

8. Laser cutting apertures with trapezoidal walls and rounded corners may offer better paste release. IPC-7525 may have alternate design recommendations.
9. Board assembly site may have different recommendations for stencil design.

IMPORTANT NOTICE AND DISCLAIMER

TI PROVIDES TECHNICAL AND RELIABILITY DATA (INCLUDING DATA SHEETS), DESIGN RESOURCES (INCLUDING REFERENCE DESIGNS), APPLICATION OR OTHER DESIGN ADVICE, WEB TOOLS, SAFETY INFORMATION, AND OTHER RESOURCES "AS IS" AND WITH ALL FAULTS, AND DISCLAIMS ALL WARRANTIES, EXPRESS AND IMPLIED, INCLUDING WITHOUT LIMITATION ANY IMPLIED WARRANTIES OF MERCHANTABILITY, FITNESS FOR A PARTICULAR PURPOSE OR NON-INFRINGEMENT OF THIRD PARTY INTELLECTUAL PROPERTY RIGHTS.

These resources are intended for skilled developers designing with TI products. You are solely responsible for (1) selecting the appropriate TI products for your application, (2) designing, validating and testing your application, and (3) ensuring your application meets applicable standards, and any other safety, security, regulatory or other requirements.

These resources are subject to change without notice. TI grants you permission to use these resources only for development of an application that uses the TI products described in the resource. Other reproduction and display of these resources is prohibited. No license is granted to any other TI intellectual property right or to any third party intellectual property right. TI disclaims responsibility for, and you will fully indemnify TI and its representatives against, any claims, damages, costs, losses, and liabilities arising out of your use of these resources.

TI's products are provided subject to [TI's Terms of Sale](#) or other applicable terms available either on ti.com or provided in conjunction with such TI products. TI's provision of these resources does not expand or otherwise alter TI's applicable warranties or warranty disclaimers for TI products.

TI objects to and rejects any additional or different terms you may have proposed.

Mailing Address: Texas Instruments, Post Office Box 655303, Dallas, Texas 75265
Copyright © 2021, Texas Instruments Incorporated