

RW Series Sub-miniature Rotary Switches



Features/Benefits

- 8 and 10 positions
- SMT version
- Subminiature design

Typical Applications

- Digital cameras
- Audio & visual equipment
- Consumer electronics
- Selector dial interface

How To Order

Part number list is shown below. For individual part details, please refer to the following pages.

Part Number (Part Description)	Product Details
RW-108 NS RT	8 Position Subminiature Rotary Switch
RW-1106-NS RT	10 Position Subminiature Rotary Switch

PART NUMBER	PACKAGING
RW-108 NS RT	800 pieces per reel



Specifications

CONTACT ARRANGEMENT: 1 Pole 8 Position
 CONTACT RATING: 0.1 A @ 16 V DC.
 ELECTRICAL LIFE: 10,000 cycles.
 INITIAL CONTACT RESISTANCE: 100 mΩ max.
 INSULATION RESISTANCE: 10M Ω min.
 DIELECTRIC STRENGTH: 100V (50-60 Hz).
 TWIST FORCE: 150 ± 100 gf
 OPERATING TEMPERATURE: -20°C to 70°C

Materials

KNOB: PA (UL 94V-0).
 COVER: SUS
 HOUSING: PA (UL94V-0)
 TERMINAL: Silver plated

NOTE: Specifications and materials listed above are for switches with standard options. For information on specific and custom switches, consult Customer Service Center.

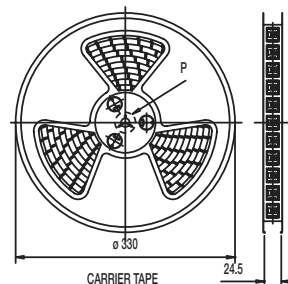
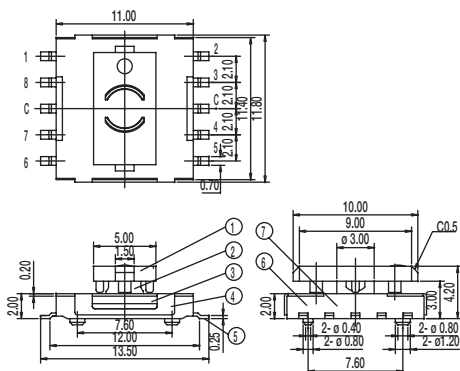

	0°	45°	90°	135°	180°	225°	270°	315°	360°
C-1	ION	ION	OFF	OFF	OFF	OFF	OFF	OFF	OFF
C-2	OFF	ION	ION	OFF	OFF	OFF	OFF	OFF	OFF
C-3	OFF	OFF	ION	ION	OFF	OFF	OFF	OFF	OFF
C-4	OFF	OFF	OFF	ION	ION	OFF	OFF	OFF	OFF
C-5	OFF	OFF	OFF	OFF	ION	ION	OFF	OFF	OFF
C-6	OFF	OFF	OFF	OFF	OFF	ION	ION	OFF	OFF
C-7	OFF	OFF	OFF	OFF	OFF	OFF	ION	ION	OFF
C-8	OFF	OFF	OFF	OFF	OFF	OFF	OFF	ION	ION

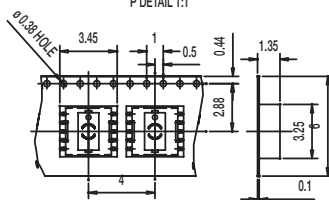
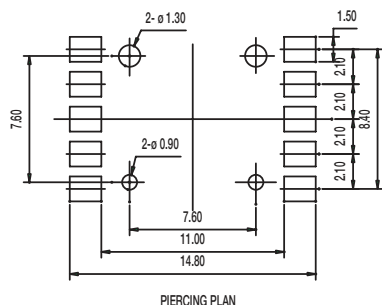
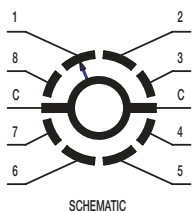
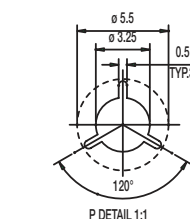

RW Series Sub-miniature Rotary Switches

PART NUMBER	PACKAGING
RW-1106-NS RT	2,000 pieces per reel



Specifications

CONTACT ARRANGEMENT: 1 Pole, 10 Position
 CONTACT RATING: 10 mA @ 5 V DC.
 ELECTRICAL LIFE: 7,000 cycles.
 INITIAL CONTACT RESISTANCE: 200 mΩ max.
 INSULATION RESISTANCE: 250M Ω min.
 DIELECTRIC STRENGTH: 250 VAC (50-60 Hz).
 TWIST FORCE: 90 ± 15 gf
 OPERATING TEMPERATURE: -30°C to 80°C

Materials

KNOB: PA (UL 94V-0).
 COVER: Silver plated.
 HOUSING: LCP (UL94V-0)
 TERMINAL: Silver plated.

NOTE: Specifications and materials listed above are for switches with standard options. For information on specific and custom switches, consult Customer Service Center.

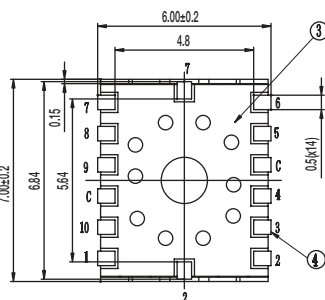
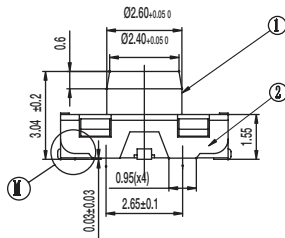
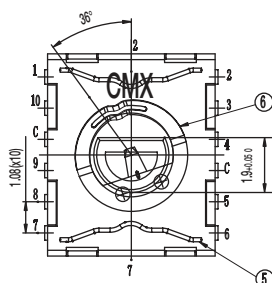
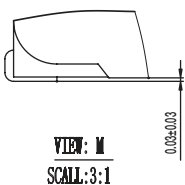
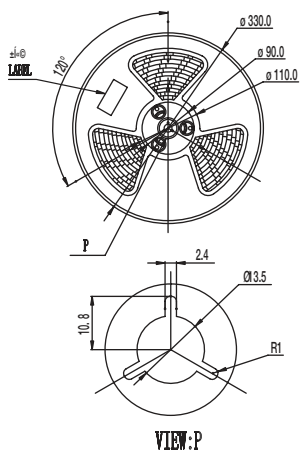
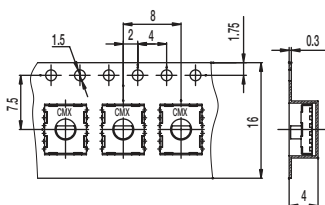

0° 36° 72° 108° 144° 180° 216° 252° 288° 324° 360°

C-1	ON											ON
C-2	OFF	ON										OFF
C-3	OFF		ON									OFF
C-4	OFF			ON								OFF
C-5	OFF				ON							OFF
C-6	OFF					ON						OFF
C-7	OFF						ON					OFF
C-8	OFF							ON				OFF
C-9	OFF								ON			OFF
C-10	OFF									ON		OFF

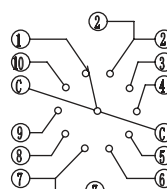

Circuit Diagram

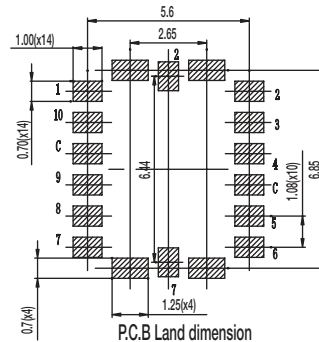

P.C.B Land dimension