

## DAISY-28X1-WW

~80° wide beam. Variant with 4X1 lenses.

### SPECIFICATION:

Dimensions	1140.0 x 40.0 mm
Height	20.2 mm
Fastening	pin, screw, clips
ROHS compliant	yes ⓘ

### MATERIALS:

Component	Type	Material	Colour	Finish
C16584_DAISY-4X1-WW	Linear lens	PMMA	clear	
C17482_DAISY-28X1-SHD-WHT-MATT	Shade	PC	white	matt
C17481_DAISY-28X1-SHD-MATT	Shade	PC	black	matt
C16783_DAISY-28X1-SHD-WHT	Shade	PC	white	gloss
C16585_DAISY-28X1-SHD	Shade	PC-ABS	black	gloss

### ORDERING INFORMATION:

#### Quantities for one set:

Linear lens	7
Shade	1



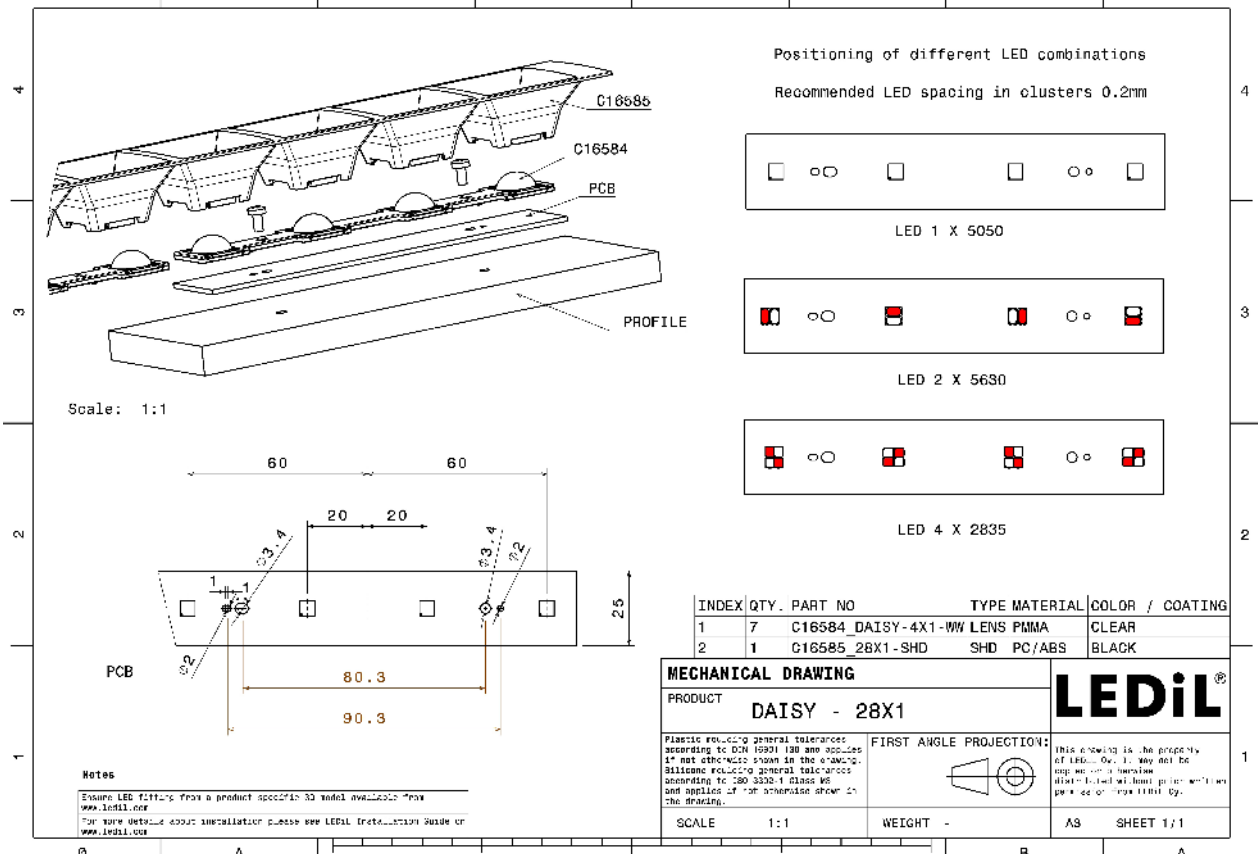
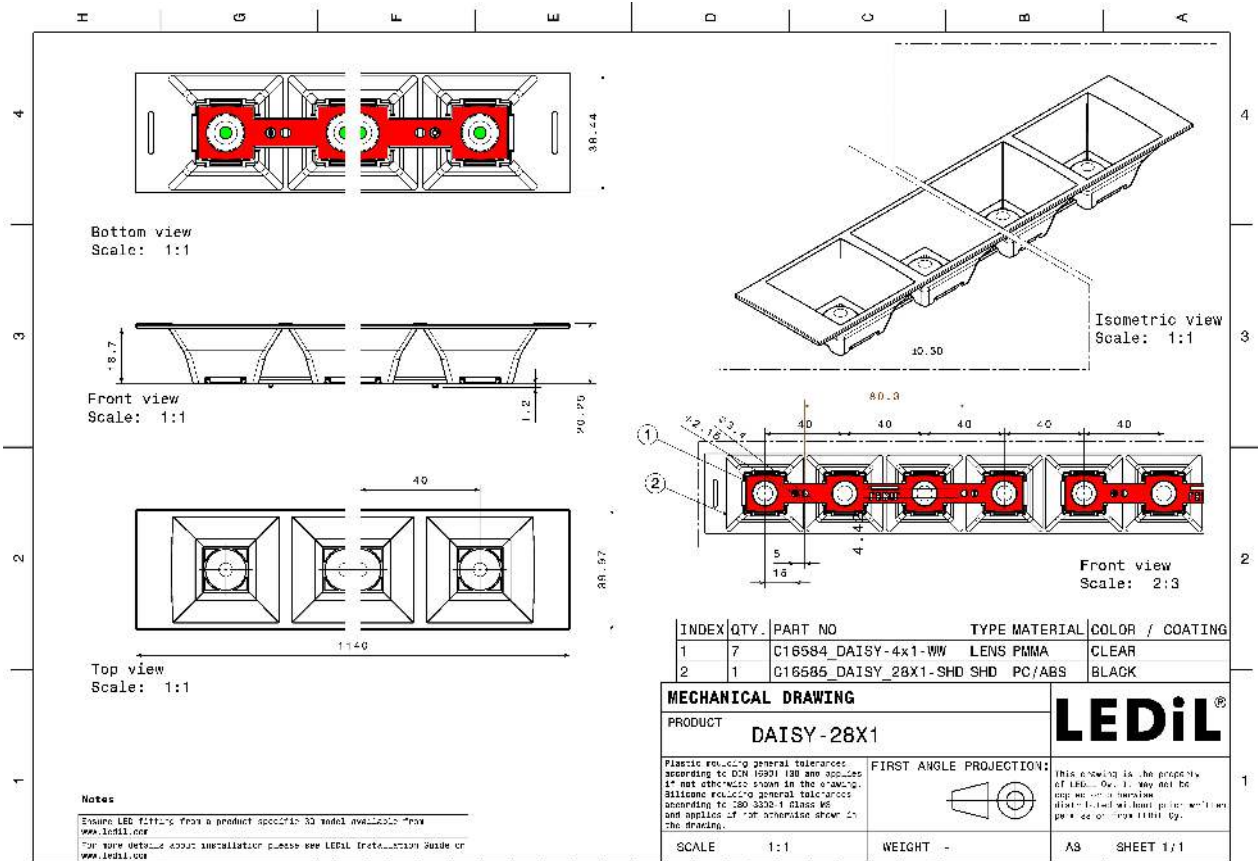

Component		Qty in box	MOQ	MPQ	Box weight (kg)
C16584_DAISY-4X1-WW » Box size: 480 x 280 x 300 mm	Linear lens	504	336	21	5.6
C17482_DAISY-28X1-SHD-WHT-MATT » Box size: 1185 x 385 x 125 mm	Shade	48	48	48	8.7
C16585_DAISY-28X1-SHD » Box size: 1185 x 385 x 125 mm	Shade	48	48	48	8.4
C16783_DAISY-28X1-SHD-WHT » Box size: 1185 x 385 x 125 mm	Shade	48	48	48	8.8
C17481_DAISY-28X1-SHD-MATT » Box size: 1185 x 385 x 125 mm	Shade	48	48	48	8.6





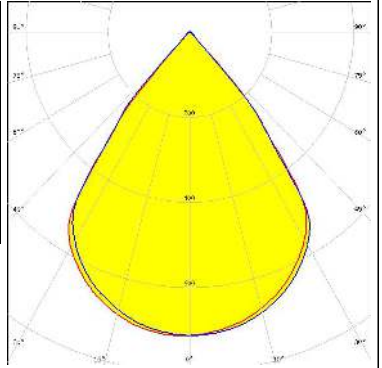
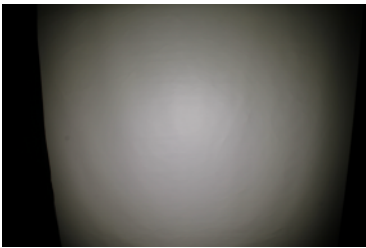
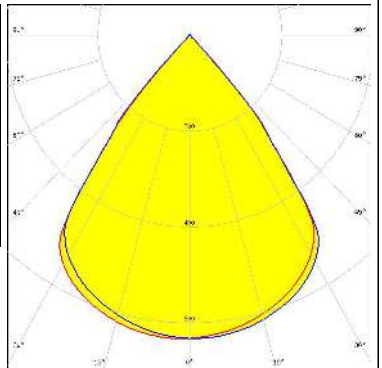
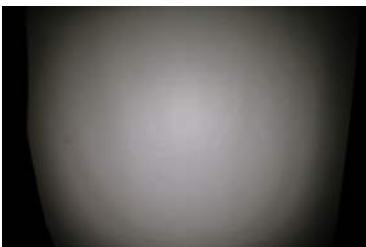
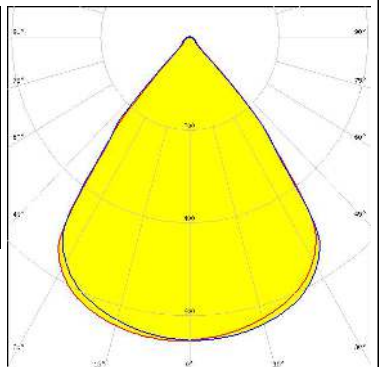

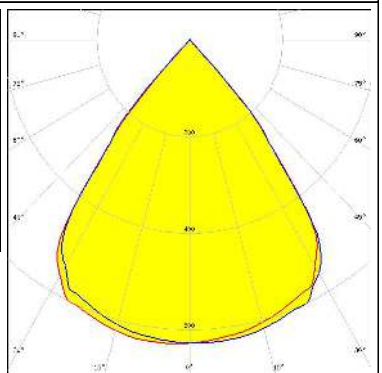

See also our general installation guide: [www.ledil.com/installation\\_guide](http://www.ledil.com/installation_guide)

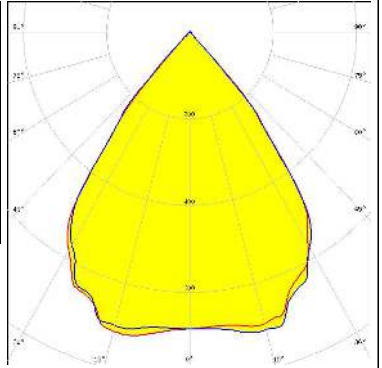
### OPTICAL RESULTS (MEASURED):

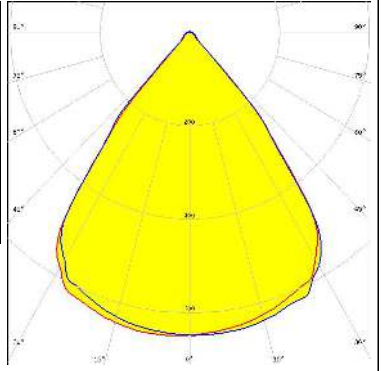

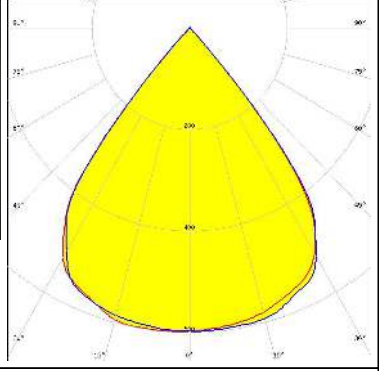

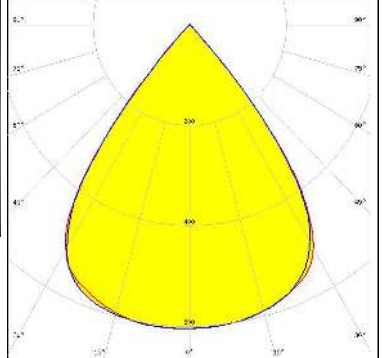

<p><b>AUDAX</b> ELECTRONICS</p> <p>LED LIGHT ENGINE DAISY 112 LEDs 1,140mm x 20mm            FWHM / FWTM 75.0° / 87.0°            Efficiency 94 %            Peak intensity 0.7 cd/m            LEDs/each optic 4            Light colour White            Required components:            C17537_DAISSY-28X1-SHD-MET-MATT</p>		
<p><b>AUDAX</b> ELECTRONICS</p> <p>LED LIGHT ENGINE DAISY 112 LEDs 1,140mm x 20mm            FWHM / FWTM 76.0° / 87.0°            Efficiency 86 %            Peak intensity 0.6 cd/m            LEDs/each optic 4            Light colour White            Required components:            C17481_DAISSY-28X1-SHD-MATT</p>		
<p><b>AUDAX</b> ELECTRONICS</p> <p>LED LIGHT ENGINE DAISY 112 LEDs 1,140mm x 20mm            FWHM / FWTM 76.0° / 87.5°            Efficiency 95 %            Peak intensity 0.7 cd/m            LEDs/each optic 4            Light colour White            Required components:            C17482_DAISSY-28X1-SHD-WHT-MATT</p>		
<p><b>AUDAX</b> ELECTRONICS</p> <p>LED LIGHT ENGINE DAISY 112 LEDs 1,140mm x 20mm            FWHM / FWTM 76.0° / 87.0°            Efficiency 87 %            Peak intensity 0.6 cd/m            LEDs/each optic 4            Light colour White            Required components:            C16585_DAISSY-28X1-SHD</p>		

### OPTICAL RESULTS (MEASURED):

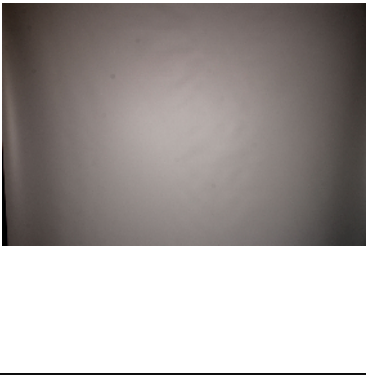
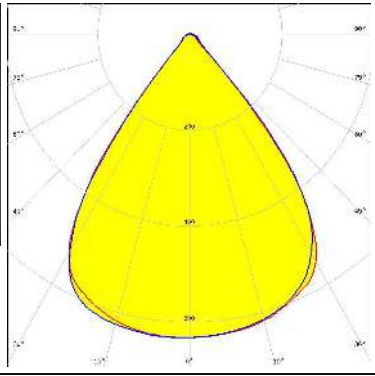

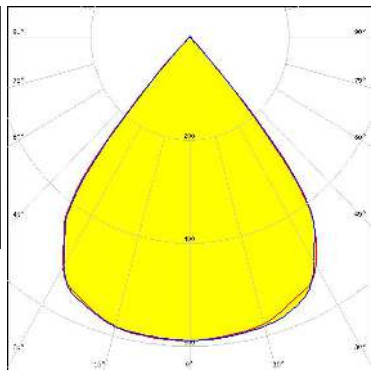

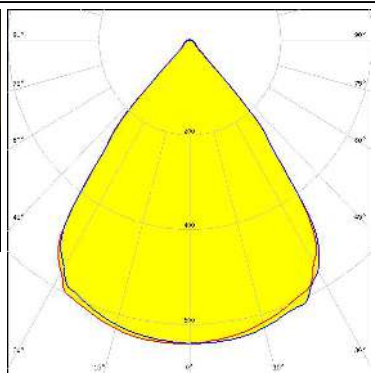
<p><b>AUDAX</b> ELECTRONICS</p> <p>LED LIGHT ENGINE DAISY 112 LEDs 1,140mm x 20mm            FWHM / FWTM 74.0° / 87.0°            Efficiency 96 %            Peak intensity 0.7 cd/m            LEDs/each optic 4            Light colour White            Required components:            C17527_DAISSY-28X1-SHD-MET</p>		
<p><b>AUDAX</b> ELECTRONICS</p> <p>LED LIGHT ENGINE DAISY 112 LEDs 1,140mm x 20mm            FWHM / FWTM 76.0° / 87.5°            Efficiency 95 %            Peak intensity 0.7 cd/m            LEDs/each optic 1            Light colour White            Required components:            C16783_DAISSY-28X1-SHD-WHT</p>		
<p><b>CREE</b> LED</p> <p>LED J Series 2835            FWHM / FWTM 77.0° / 86.0°            Efficiency 87 %            Peak intensity 0.6 cd/m            LEDs/each optic 2            Light colour White            Required components:            C16585_DAISSY-28X1-SHD</p>		
<p><b>Helvar</b></p> <p>LED LDL-iC-562-827-2000lm            FWHM / FWTM 75.0° / 86.0°            Efficiency 83 %            Peak intensity 0.6 cd/m            LEDs/each optic 1            Light colour White            Required components:            C16585_DAISSY-28X1-SHD</p>		

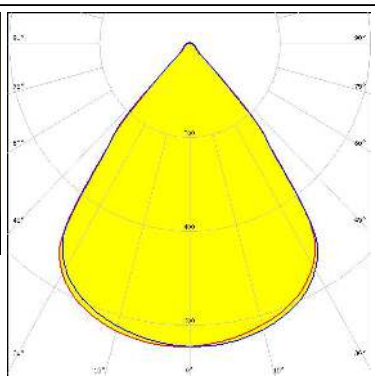



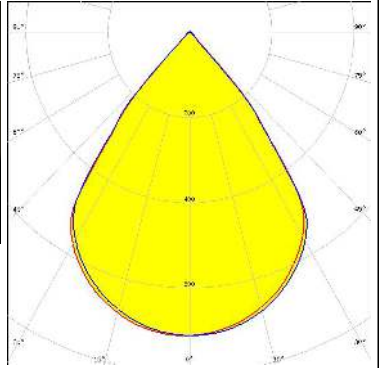
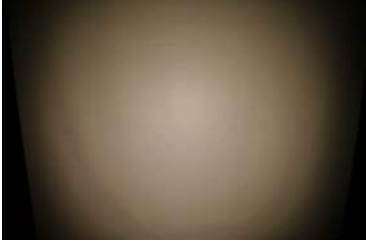
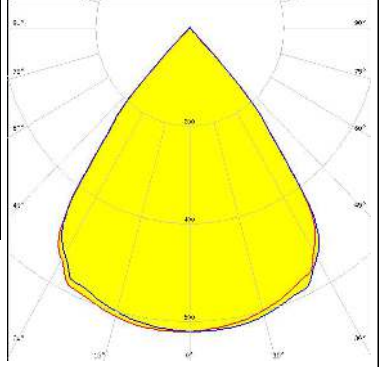

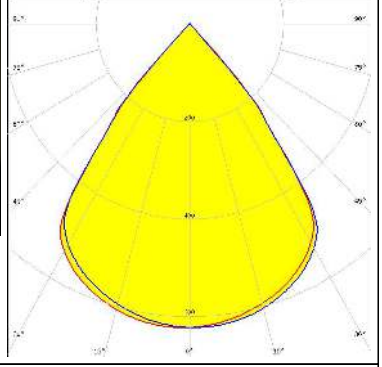
### OPTICAL RESULTS (MEASURED):

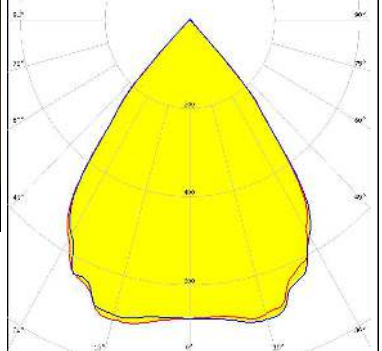
<p><b>Helvar</b></p> <p>LED LDL-iC-562-827-2000lm            FWHM / FWTM 75.0° / 88.0°            Efficiency 92 %            Peak intensity 0.6 cd/lm            LEDs/each optic 1            Light colour White            Required components:            C16783_DAISSY-28X1-SHD-WHT</p>		
<p><b>LUMILEDS</b></p> <p>LED LUXEON 2835 Line            FWHM / FWTM 78.0° / 86.0°            Efficiency 87 %            Peak intensity 0.6 cd/lm            LEDs/each optic 2            Light colour White            Required components:            C16585_DAISSY-28X1-SHD</p>		
<p><b>MST</b> <i>Your solutions</i></p> <p>LED LinLED 1120x28mm 2200lm 8x0 2C 84V Opt G1            FWHM / FWTM 76.5° / 88.5 + 88.0°            Efficiency 94 %            Peak intensity 0.6 cd/lm            LEDs/each optic 2            Light colour White            Required components:            C16783_DAISSY-28X1-SHD-WHT</p>		
<p><b>MST</b> <i>Your solutions</i></p> <p>LED LinLED 1120x28mm 2200lm 8x0 2C 84V Opt G1            FWHM / FWTM 76.0 + 76.5° / 88.0°            Efficiency 94 %            Peak intensity 0.6 cd/lm            LEDs/each optic 2            Light colour White            Required components:            C17482_DAISSY-28X1-SHD-WHT-MATT</p>		

### OPTICAL RESULTS (MEASURED):

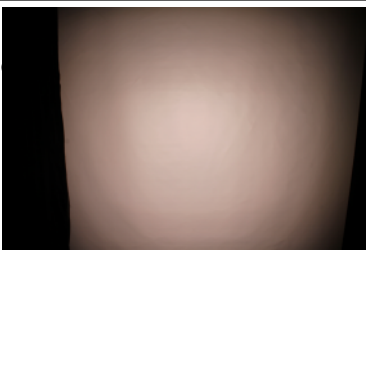
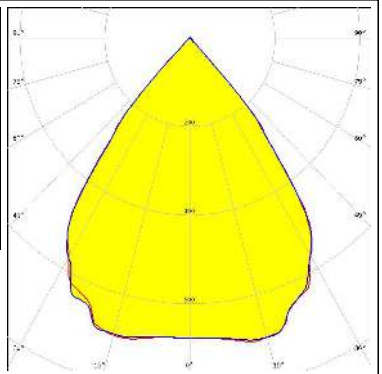
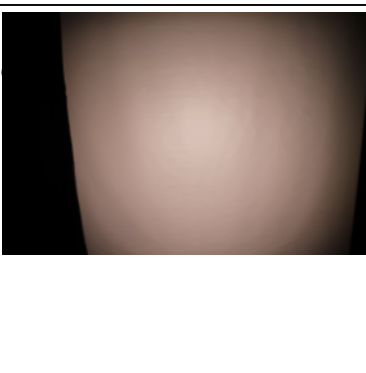
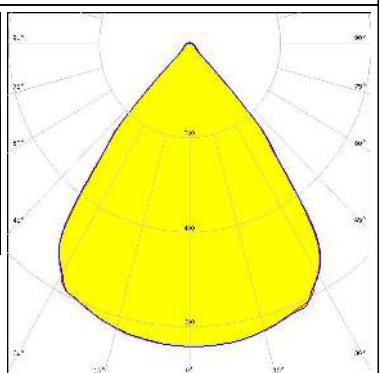

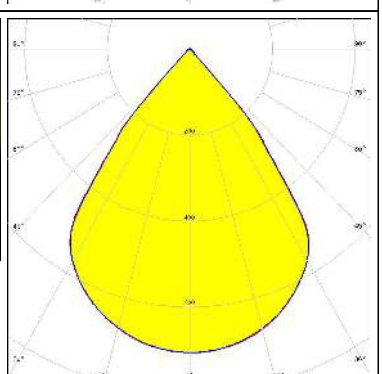
<p><b>MST</b> <i>Your solutions</i></p> <p>LED LinLED 1120x28mm 2200lm 8x0 2C 84V Opt G1            FWHM / FWTM 74.5° / 87.5°            Efficiency 94 %            Peak intensity 0.7 cd/lm            LEDs/each optic 2            Light colour White            Required components:            C17537_DAISSY-28X1-SHD-MET-MATT</p>		
<p><b>MST</b> <i>Your solutions</i></p> <p>LED LinLED 1120x28mm 2200lm 8x0 2C 84V Opt G1            FWHM / FWTM 76.0 + 75.5° / 87.5 + 87.0°            Efficiency 86 %            Peak intensity 0.6 cd/lm            LEDs/each optic 2            Light colour White            Required components:            C16585_DAISSY-28X1-SHD</p>		
<p><b>MST</b> <i>Your solutions</i></p> <p>LED LinLED 1120x28mm 2200lm 8x0 2C 84V Opt G1            FWHM / FWTM 75.5 + 76.0° / 87.5°            Efficiency 85 %            Peak intensity 0.6 cd/lm            LEDs/each optic 2            Light colour White            Required components:            C17481_DAISSY-28X1-SHD-MATT</p>		
<p><b>MST</b> <i>Your solutions</i></p> <p>LED LinLED 1120x28mm 2200lm 8x0 2C 84V Opt G1            FWHM / FWTM 74.5° / 87.5 + 87.0°            Efficiency 95 %            Peak intensity 0.7 cd/lm            LEDs/each optic 2            Light colour White            Required components:            C17527_DAISSY-28X1-SHD-MET</p>		

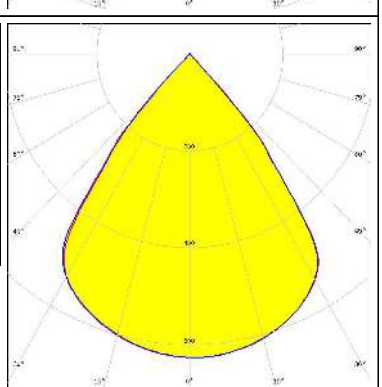
### OPTICAL RESULTS (MEASURED):



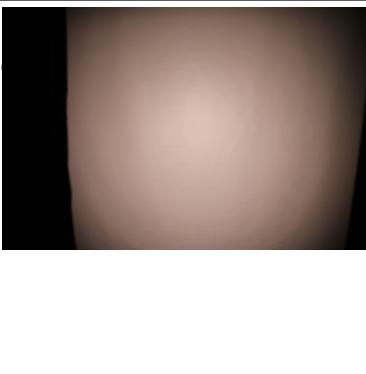
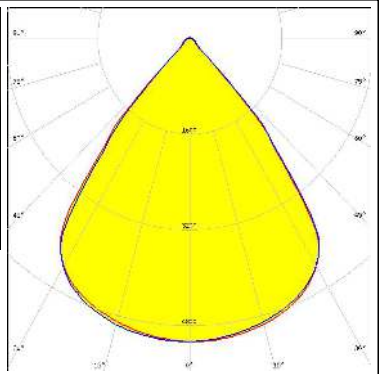
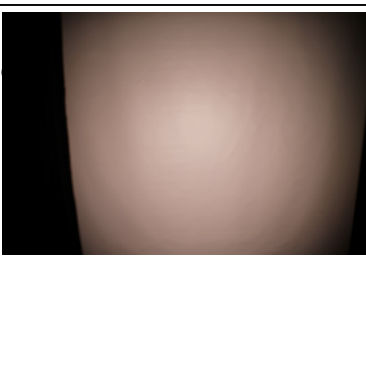
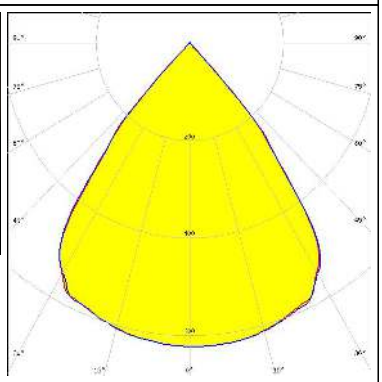

<p><b>MST</b> <i>Your solutions</i></p> <p>LED LinLED 1120x28mm 2x2200lm 827-865 2x2C 84V DAISY</p> <p>FWHM / FWTM 74.5 + 75.5° / 87.5°</p> <p>Efficiency 95 %</p> <p>Peak intensity 0.7 cd/lm</p> <p>LEDs/each optic 4</p> <p>Light colour Tunable White</p> <p>Required components: C17527_DAISSY-28X1-SHD-MET</p>		
<p><b>MST</b> <i>Your solutions</i></p> <p>LED LinLED 1120x28mm 2x2200lm 827-865 2x2C 84V DAISY</p> <p>FWHM / FWTM 76.5 + 77.0° / 88.5°</p> <p>Efficiency 95 %</p> <p>Peak intensity 0.6 cd/lm</p> <p>LEDs/each optic 4</p> <p>Light colour Tunable White</p> <p>Required components: C16783_DAISSY-28X1-SHD-WHT</p>		
<p><b>MST</b> <i>Your solutions</i></p> <p>LED LinLED 1120x28mm 2x2200lm 827-865 2x2C 84V DAISY</p> <p>FWHM / FWTM 75.5° / 88.0 + 87.5°</p> <p>Efficiency 94 %</p> <p>Peak intensity 0.7 cd/lm</p> <p>LEDs/each optic 4</p> <p>Light colour Tunable White</p> <p>Required components: C17537_DAISSY-28X1-SHD-MET-MATT</p>		
<p><b>MST</b> <i>Your solutions</i></p> <p>LED LinLED 1120x28mm 2x2200lm 827-865 2x2C 84V DAISY</p> <p>FWHM / FWTM 76.0 + 76.5° / 87.5°</p> <p>Efficiency 86 %</p> <p>Peak intensity 0.6 cd/lm</p> <p>LEDs/each optic 4</p> <p>Light colour Tunable White</p> <p>Required components: C17481_DAISSY-28X1-SHD-MATT</p>		

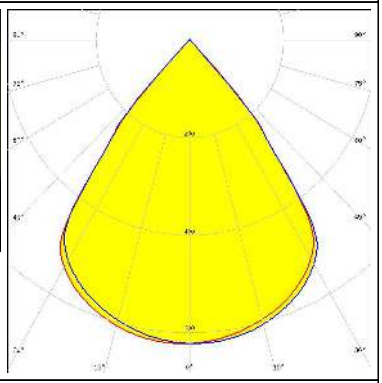
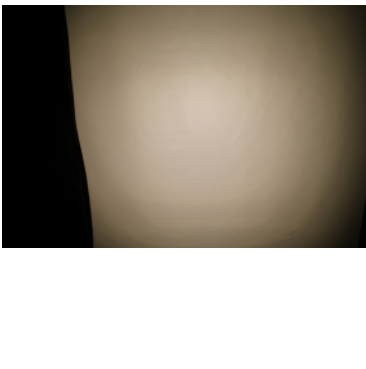
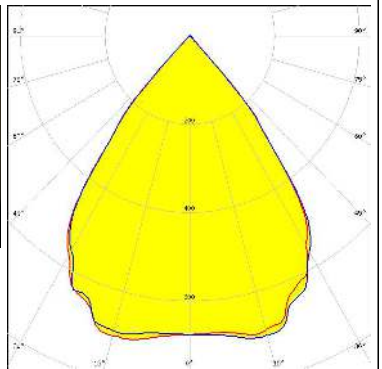

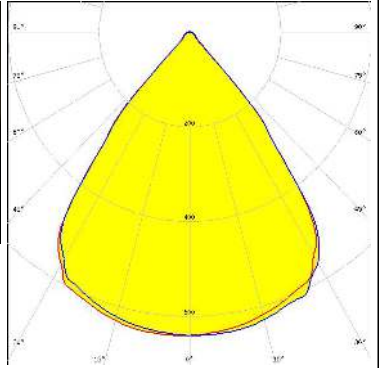

### OPTICAL RESULTS (MEASURED):

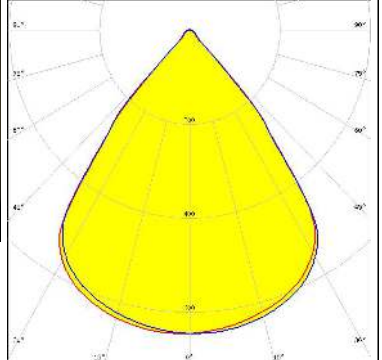
<p><b>MST</b> <i>Your solutions</i></p> <p>LED LinLED 1120x28mm 2x2200lm 827-865 2x2C 84V DAISY</p> <p>FWHM / FWTM 76.5 + 77.0° / 88.5°</p> <p>Efficiency 95 %</p> <p>Peak intensity 0.6 cd/lm</p> <p>LEDs/each optic 4</p> <p>Light colour Tunable White</p> <p>Required components: C17482_DAISSY-28X1-SHD-WHT-MATT</p>		
<p><b>MST</b> <i>Your solutions</i></p> <p>LED LinLED 1120x28mm 2x2200lm 827-865 2x2C 84V DAISY</p> <p>FWHM / FWTM 76.0 + 76.5° / 87.5°</p> <p>Efficiency 87 %</p> <p>Peak intensity 0.6 cd/lm</p> <p>LEDs/each optic 4</p> <p>Light colour Tunable White</p> <p>Required components: C16585_DAISSY-28X1-SHD</p>		
<p><b>MST</b> <i>Your solutions</i></p> <p>LED LinLED 1120x28mm 4400lm 8x0 2C Opt G1</p> <p>FWHM / FWTM 75.5 + 76.0° / 87.5°</p> <p>Efficiency 85 %</p> <p>Peak intensity 0.6 cd/lm</p> <p>LEDs/each optic 4</p> <p>Light colour White</p> <p>Required components: C17481_DAISSY-28X1-SHD-MATT</p>		
<p><b>MST</b> <i>Your solutions</i></p> <p>LED LinLED 1120x28mm 4400lm 8x0 2C Opt G1</p> <p>FWHM / FWTM 74.5° / 87.5 + 87.0°</p> <p>Efficiency 95 %</p> <p>Peak intensity 0.7 cd/lm</p> <p>LEDs/each optic 4</p> <p>Light colour White</p> <p>Required components: C17527_DAISSY-28X1-SHD-MET</p>		

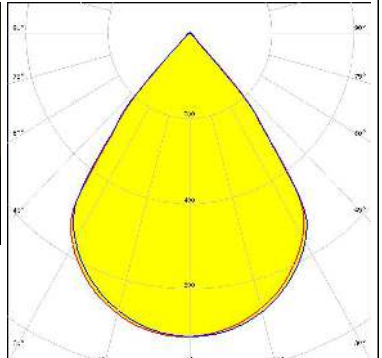
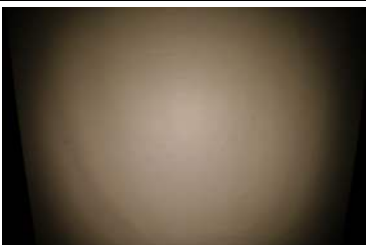
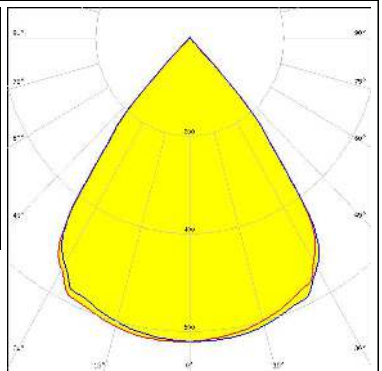

### OPTICAL RESULTS (MEASURED):

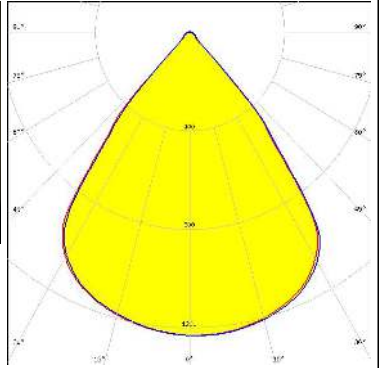
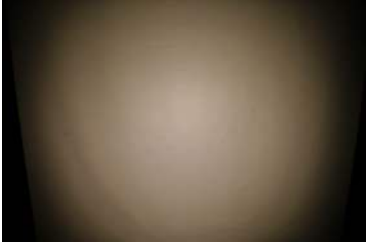
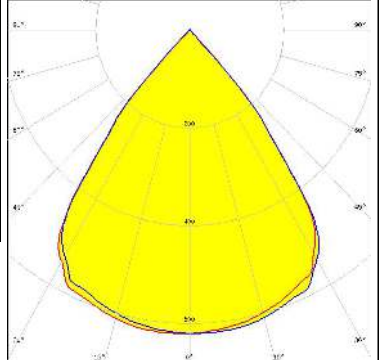
<p><b>MST</b> <i>Your solutions</i></p> <p>LED LinLED 1120x28mm 4400lm 8x0 2C Opt G1            FWHM / FWTM 76.5° / 88.5 + 88.0°            Efficiency 94 %            Peak intensity 0.6 cd/lm            LEDs/each optic 4            Light colour White            Required components:            C16783_DAISSY-28X1-SHD-WHT</p>		
<p><b>MST</b> <i>Your solutions</i></p> <p>LED LinLED 1120x28mm 4400lm 8x0 2C Opt G1            FWHM / FWTM 76.0 + 76.5° / 88.0°            Efficiency 94 %            Peak intensity 0.6 cd/lm            LEDs/each optic 4            Light colour White            Required components:            C17482_DAISSY-28X1-SHD-WHT-MATT</p>		
<p><b>MST</b> <i>Your solutions</i></p> <p>LED LinLED 1120x28mm 4400lm 8x0 2C Opt G1            FWHM / FWTM 74.5° / 87.5°            Efficiency 94 %            Peak intensity 0.7 cd/lm            LEDs/each optic 4            Light colour White            Required components:            C17537_DAISSY-28X1-SHD-MET-MATT</p>		
<p><b>MST</b> <i>Your solutions</i></p> <p>LED LinLED 1120x28mm 4400lm 8x0 2C Opt G1            FWHM / FWTM 76.0 + 75.5° / 87.5 + 87.0°            Efficiency 86 %            Peak intensity 0.6 cd/lm            LEDs/each optic 4            Light colour White            Required components:            C16585_DAISSY-28X1-SHD</p>		

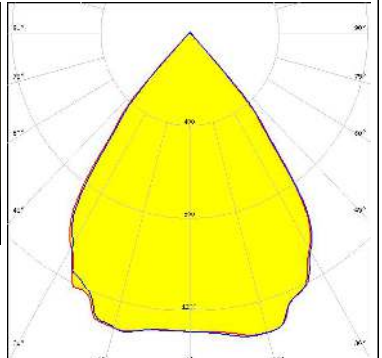
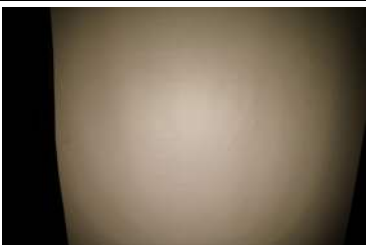
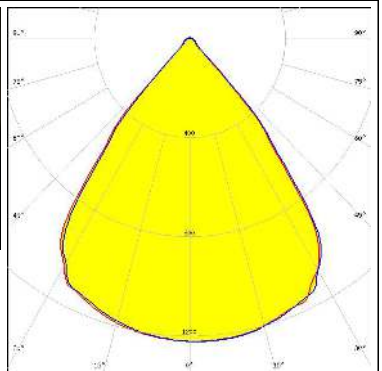
### OPTICAL RESULTS (MEASURED):

<p><b>MST</b> <i>Your solutions</i></p> <p>LED LinLED 1120x28mm 4400lm 8x0 4C Opt G1            FWHM / FWTM 76.0 + 76.5° / 88.0°            Efficiency 94 %            Peak intensity 0.6 cd/lm            LEDs/each optic 4            Light colour White            Required components:            C17482_DAISSY-28X1-SHD-WHT-MATT</p>		
<p><b>MST</b> <i>Your solutions</i></p> <p>LED LinLED 1120x28mm 4400lm 8x0 4C Opt G1            FWHM / FWTM 76.0 + 75.5° / 87.5 + 87.0°            Efficiency 86 %            Peak intensity 0.6 cd/lm            LEDs/each optic 4            Light colour White            Required components:            C16585_DAISSY-28X1-SHD</p>		
<p><b>MST</b> <i>Your solutions</i></p> <p>LED LinLED 1120x28mm 4400lm 8x0 4C Opt G1            FWHM / FWTM 74.5° / 87.5 + 87.0°            Efficiency 95 %            Peak intensity 0.7 cd/lm            LEDs/each optic 4            Light colour White            Required components:            C17527_DAISSY-28X1-SHD-MET</p>		
<p><b>MST</b> <i>Your solutions</i></p> <p>LED LinLED 1120x28mm 4400lm 8x0 4C Opt G1            FWHM / FWTM 76.5° / 88.5 + 88.0°            Efficiency 94 %            Peak intensity 0.6 cd/lm            LEDs/each optic 4            Light colour White            Required components:            C16783_DAISSY-28X1-SHD-WHT</p>		

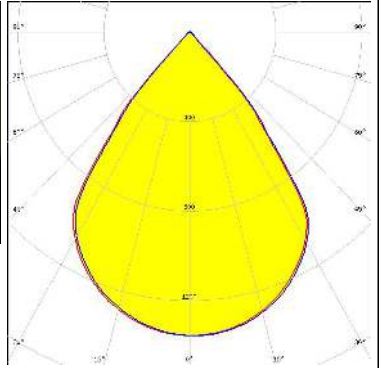
### OPTICAL RESULTS (MEASURED):

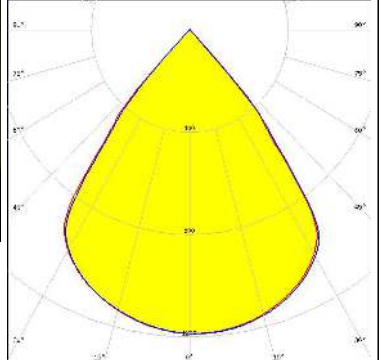
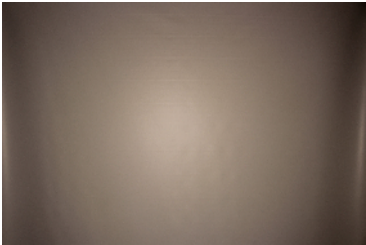
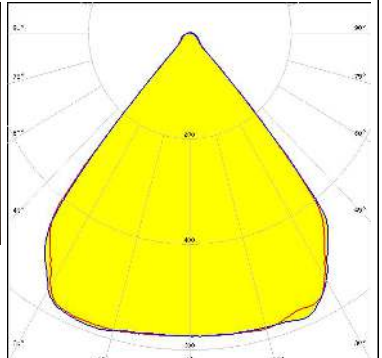
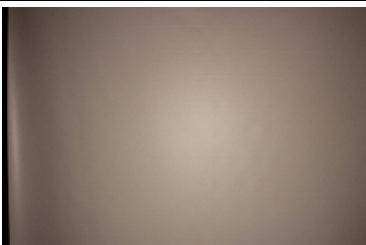
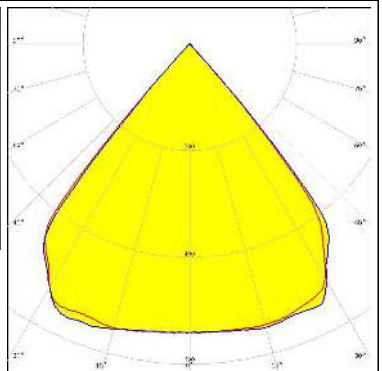
<p><b>MST</b> <i>Your solutions</i></p> <p>LED LinLED 1120x28mm 4400lm 8x0 4C Opt G1            FWHM / FWTM 74.5° / 87.5°            Efficiency 94 %            Peak intensity 0.7 cd/lm            LEDs/each optic 4            Light colour White            Required components:            C17537_DAISSY-28X1-SHD-MET-MATT</p>		
<p><b>MST</b> <i>Your solutions</i></p> <p>LED LinLED 1120x28mm 4400lm 8x0 4C Opt G1            FWHM / FWTM 75.5 + 76.0° / 87.5°            Efficiency 85 %            Peak intensity 0.6 cd/lm            LEDs/each optic 4            Light colour White            Required components:            C17481_DAISSY-28X1-SHD-MATT</p>		
<p><b>NICHIA</b></p> <p>LED NF2W757G-MT (Tunable White)            FWHM / FWTM 80.0° / 86.0°            Efficiency 97 %            Peak intensity 0.6 cd/lm            LEDs/each optic 1            Light colour Tunable White            Required components:            C16783_DAISSY-28X1-SHD-WHT</p>		
<p><b>NICHIA</b></p> <p>LED NF2W757G-MT (Tunable White)            FWHM / FWTM 79.0° / 85.0°            Efficiency 86 %            Peak intensity 0.6 cd/lm            LEDs/each optic 1            Light colour Tunable White            Required components:            C16585_DAISSY-28X1-SHD</p>		



### OPTICAL RESULTS (MEASURED):

#### SAMSUNG

LED LM28xB Series  
 FWHM / FWTM 77.0° / 87.0°  
 Efficiency 94 %  
 Peak intensity 0.6 cd/m  
 LEDs/each optic 2  
 Light colour White  
 Required components:  
 C16783\_DAISY-28X1-SHD-WHT

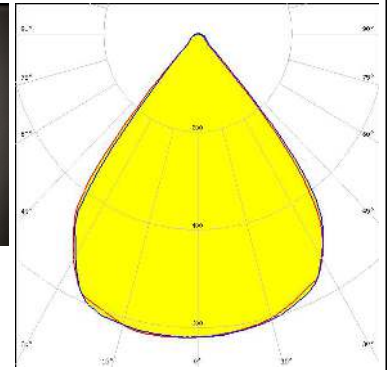
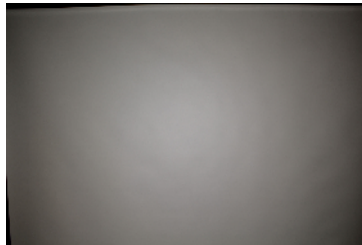

#### SAMSUNG

LED LM28xB Series  
 FWHM / FWTM 78.0° / 86.0°  
 Efficiency 84 %  
 Peak intensity 0.6 cd/m  
 LEDs/each optic 2  
 Light colour White  
 Required components:  
 C16585\_DAISY-28X1-SHD

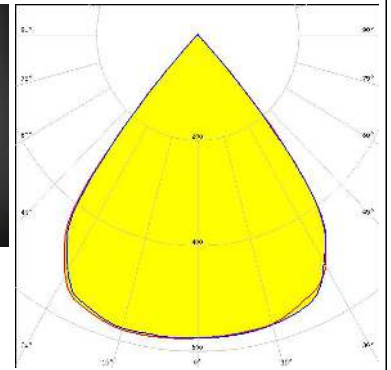

SEOUL SEMICONDUCTOR  
 LED SEOUL DC 3528  
 FWHM / FWTM 78.0° / 86.0°  
 Efficiency 87 %  
 Peak intensity 0.6 cd/m  
 LEDs/each optic 2  
 Light colour White  
 Required components:  
 C16585\_DAISY-28X1-SHD

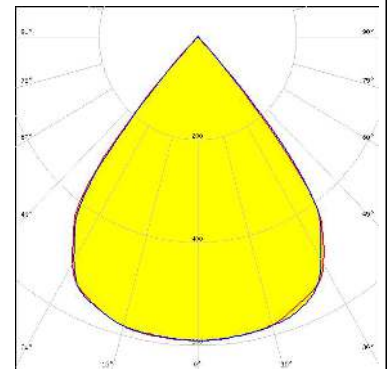

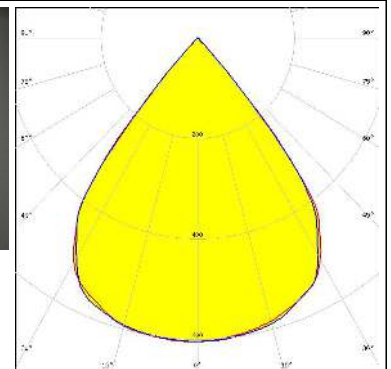

SEOUL SEMICONDUCTOR  
 LED SEOUL DC 3528  
 FWHM / FWTM 77.0° / 86.0°  
 Efficiency 87 %  
 Peak intensity 0.6 cd/m  
 LEDs/each optic 2  
 Light colour White  
 Required components:  
 C16585\_DAISY-28X1-SHD



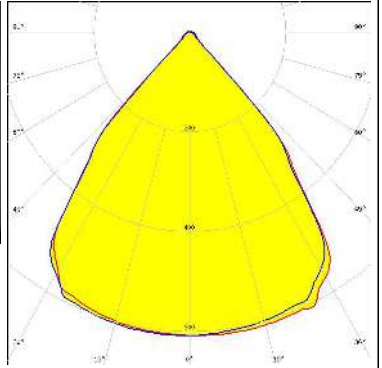

### OPTICAL RESULTS (MEASURED):

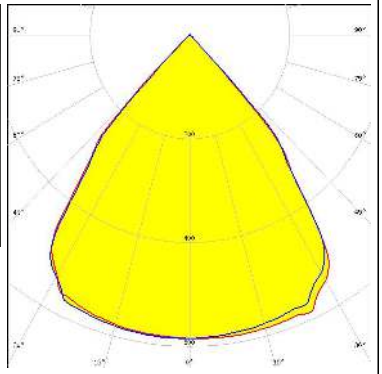
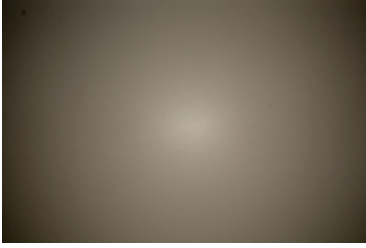
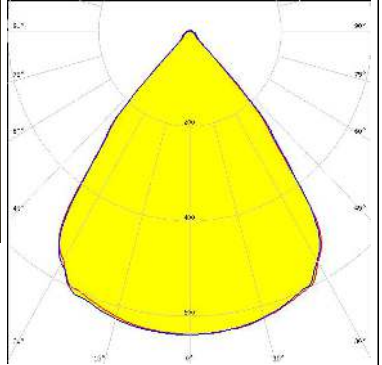
<p><b>TEPCOMP</b> group</p> <p>LED                    PassivePAQ-L-2F35-SSA3-5.4K-840-3-DC            FWHM / FWTM      82.0° / 90.0°            Efficiency            94 %            Peak intensity       0.6 cd/m            LEDs/each optic    4            Light colour         White            Required components:                                     C16783_DAISY-28X1-SHD-WHT</p>		
<p><b>TEPCOMP</b> group</p> <p>LED                    PassivePAQ-L-2F35-SSA3-5.4K-840-3-DC            FWHM / FWTM      81.0° / 90.0°            Efficiency            86 %            Peak intensity       0.6 cd/m            LEDs/each optic    4            Light colour         White            Required components:                                     C16585_DAISY-28X1-SHD</p>		
<p><b>TRIDONIC</b></p> <p>LED                    LLE 24x280mm 750lm 8x0 LVD ADV1            FWHM / FWTM      77.0° / 88.0°            Efficiency            94 %            Peak intensity       0.6 cd/m            LEDs/each optic    1            Light colour         White            Required components:                                     C16783_DAISY-28X1-SHD-WHT</p>		

### OPTICAL RESULTS (SIMULATED):

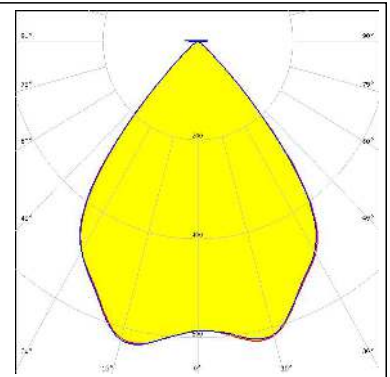
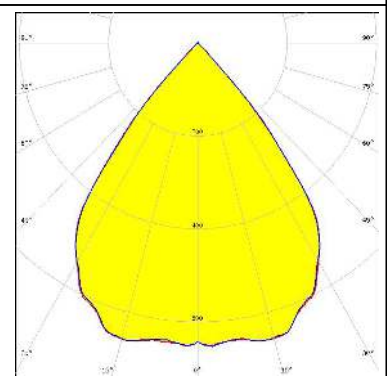
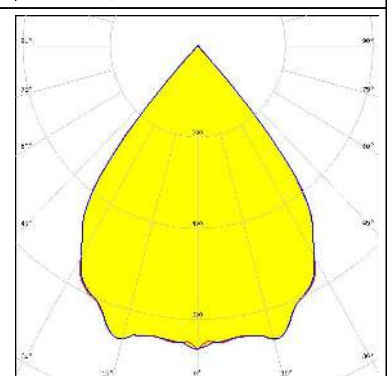
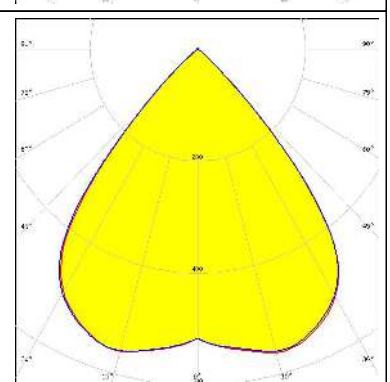
<p><b>CREE</b> LED</p> <p>LED: XD16            FWHM / FWTM: 76.0° / 93.0°            Efficiency: 88 %            Peak intensity: 0.6 cd/lm            LEDs/each optic: 1            Light colour: White            Required components:            C16585_DAISY-28X1-SHD</p>	
<p><b>NICHIA</b></p> <p>LED: NF2W757G-MT (Tunable White)            FWHM / FWTM: 76.0° / 88.0°            Efficiency: 90 %            Peak intensity: 0.7 cd/lm            LEDs/each optic: 4            Light colour: Tunable White            Required components:            C16585_DAISY-28X1-SHD</p>	
<p><b>NICHIA</b></p> <p>LED: NF2W757G-MT (Tunable White)            FWHM / FWTM: 76.0 + 78.0° / 86.0°            Efficiency: 90 %            Peak intensity: 0.7 cd/lm            LEDs/each optic: 2            Light colour: Tunable White            Required components:            C16585_DAISY-28X1-SHD</p>	
<p><b>NICHIA</b></p> <p>LED: NVSxx19B/NVSxx19C            FWHM / FWTM: 79.2° / 94.2°            Efficiency: 87 %            Peak intensity: 0.6 cd/lm            LEDs/each optic: 1            Light colour: White            Required components:            C16585_DAISY-28X1-SHD</p>	

### GENERAL INFORMATION:

NOTE: The typical beam angle will be changed by different color, chip size and chip position tolerance. The typical total beam angle is the full angle measured where the luminous intensity is half of the peak value.

### MATERIALS:

As part of our continuous research and improvement processes, and to ensure the best possible quality and availability of our products, LEDiL reserves the right to change material grades without notice.

### PRODUCT DATA USER AGREEMENT AND DISCLAIMER:

The measured data in the provided downloadable LEDiL Product Datasheets and Mechanical 2D-Drawings is rounded and provided as reference for planning. LEDiL Oy's optical specifications have been verified by conducting performance testing of the products in accordance with the company's quality system. The reported data are averaged results of multiple measurements with typical variation. LEDiL Oy reserves the right to without prior notification make changes and improvements to its products.

LEDiL Oy assumes neither warranty, nor guarantee nor any other liability of any kind for the contents and correctness of the provided data. The provided data has been generated with highest diligence but the provided data may in reality not represent the complete possible variation range of all intrinsic parameters. Therefore, in certain cases a deviation from the provided data could occur.

LEDiL Oy reserves the right to undertake technical changes of its products without further notification which could lead to changes in the provided data. LEDiL Oy assumes no liability of any kind for the possible deviation from any provided data or any other damage resulting from the usage of the provided data.

The user agrees to this disclaimer and user agreement with the download or usage of the provided files.

#### LEDiL Oy

Joensuunkatu 13  
FI-24240 SALO  
Finland

#### LEDiL Inc.

228 West Page Street  
Suite D  
Sycamore IL 60178  
USA

#### Ledil Optics Technology (Shenzhen) Co., Ltd.

# 405 , Block B  
Casic Motor Building  
Shenzhen 518057  
P.R.CHINA

#### Local sales and technical support

[www.ledil.com/  
where\\_to\\_buy](http://www.ledil.com/where_to_buy)

#### Shipping locations

Salo, Finland  
Hong Kong, China

#### Distribution Partners

[www.ledil.com/  
where\\_to\\_buy](http://www.ledil.com/where_to_buy)