

YASMEEN-70-M-C

~26° wide beam. Assembly with holder C compatible with LEDiL HEKLA. Black version.

SPECIFICATION:

Dimensions	Ø 69.9 mm
Height	39.9 mm
ROHS compliant	yes ⓘ



MATERIALS:

Component	Type	Material	Colour	Finish
YASMEEN-70-M	Single lens	PMMA	clear	
YASMEEN-70-HLD-C	Holder C	PC	black	





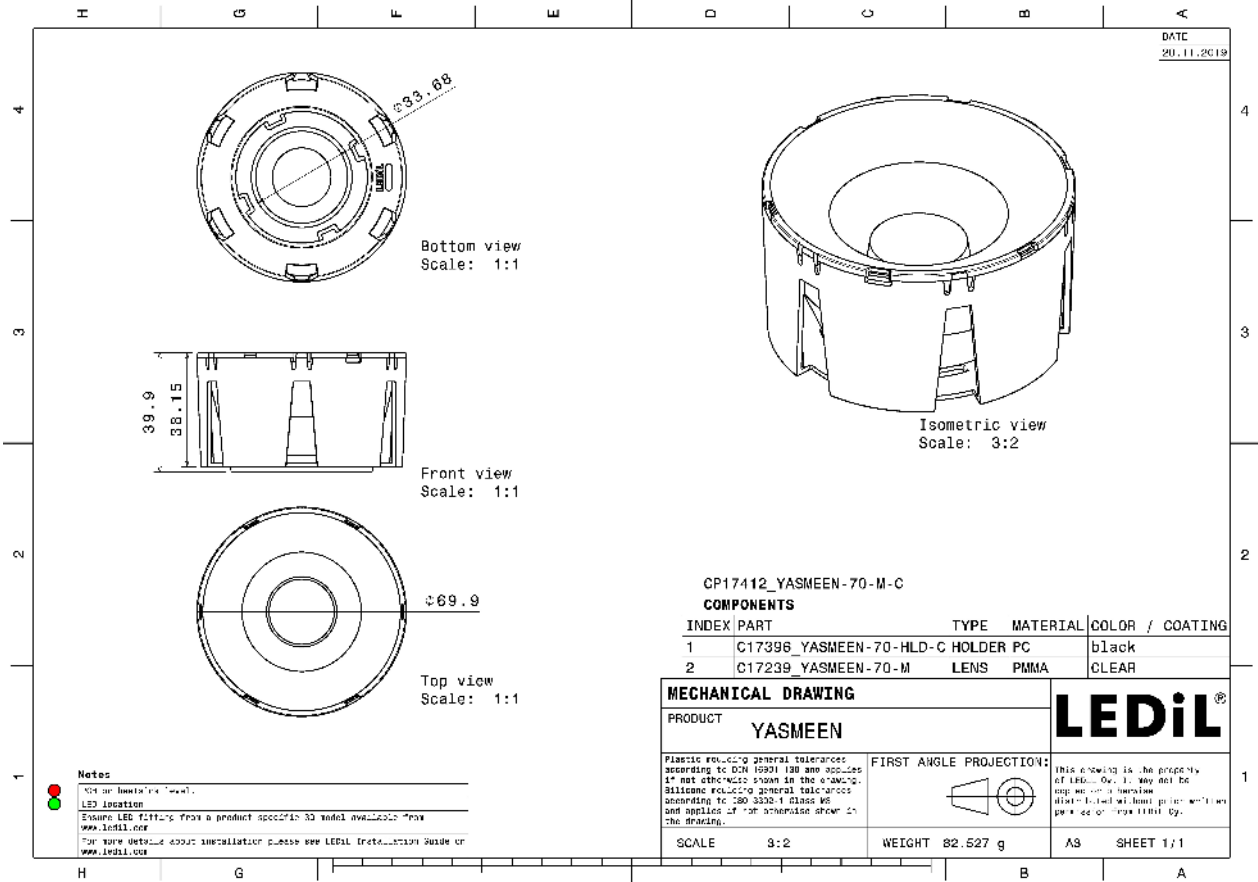

ORDERING INFORMATION:

Component	Type	Qty in box	MOQ	MPQ	Box weight (kg)
CP17412_YASMEEN-70-M-C » Box size: 476 x 273 x 305 mm	Single lens	105	105	15	10.0

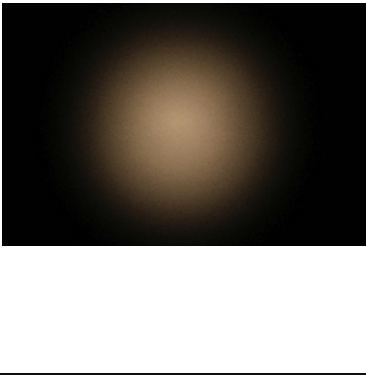
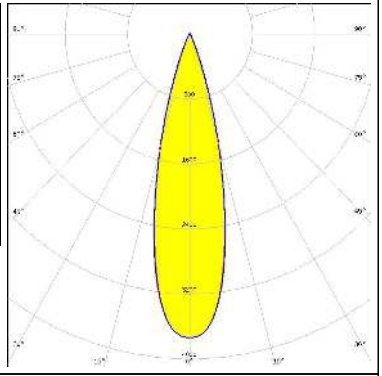

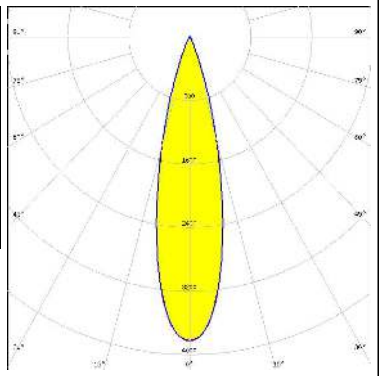

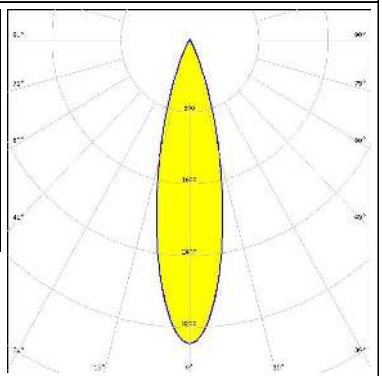

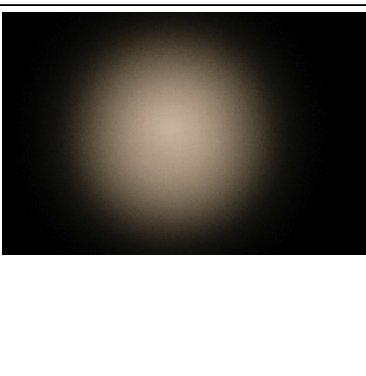
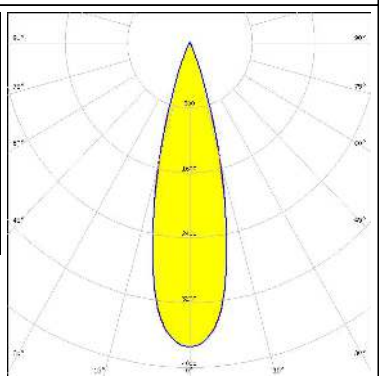



See also our general installation guide: www.ledil.com/installation_guide

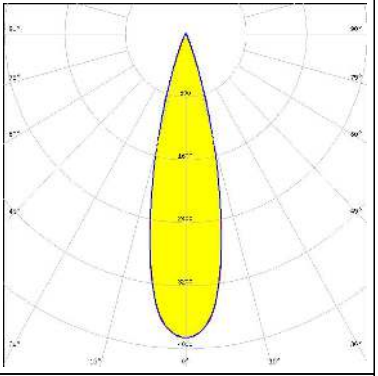

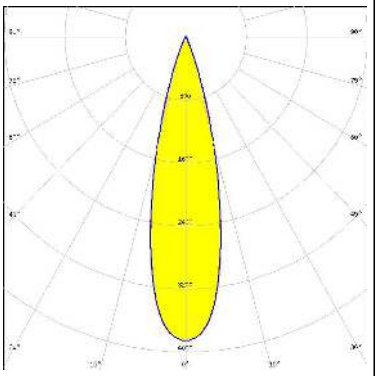

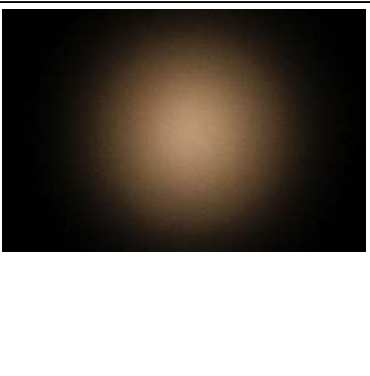
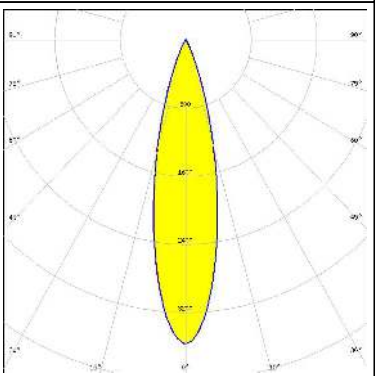

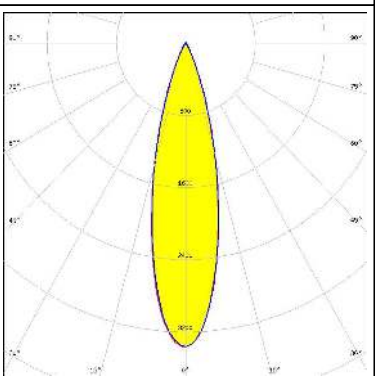

OPTICAL RESULTS (MEASURED):

<p></p> <p>LED V10 Gen 8 FWHM / FWTM 26.0° / 44.0° Efficiency 84 % Peak intensity 3.7 cd/m LEDs/each optic 1 Light colour White Required components: F15255_HEKLA-SOCKET-C</p>		
<p></p> <p>LED V11 HD Gen 8 FWHM / FWTM 25.0° / 44.0° Efficiency 82 % Peak intensity 3.8 cd/m LEDs/each optic 1 Light colour White Required components: Bender Wirth: 633d Hekla</p>		
<p></p> <p>LED V13 Gen 8 FWHM / FWTM 26.0° / 47.0° Efficiency 81 % Peak intensity 3.4 cd/m LEDs/each optic 1 Light colour White Required components: F15859_HEKLA-SOCKET-I</p>		
<p></p> <p>LED V8 Gen 8 FWHM / FWTM 27.0° / 43.0° Efficiency 85 % Peak intensity 3.7 cd/m LEDs/each optic 1 Light colour White Required components: F15253_HEKLA-SOCKET-A</p>		

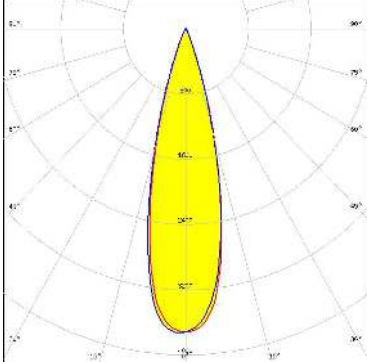
OPTICAL RESULTS (MEASURED):

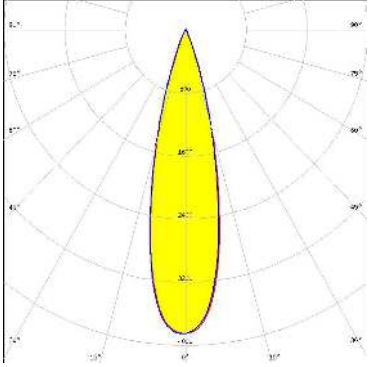
<p></p> <p>LED V9 HD Gen7</p> <p>FWHM / FWTM 26.0° / 42.0°</p> <p>Efficiency 83 %</p> <p>Peak intensity 3.9 cd/m</p> <p>LEDs/each optic 1</p> <p>Light colour White</p> <p>Required components: F15859_HEKLA-SOCKET-I</p>		
<p></p> <p>LED VERO10</p> <p>FWHM / FWTM 26.0° / 42.5°</p> <p>Efficiency 84 %</p> <p>Peak intensity 3.9 cd/m</p> <p>LEDs/each optic 1</p> <p>Light colour White</p> <p>Required components: F15616_HEKLA-SOCKET-F</p>		
<p></p> <p>LED Vesta DTW 13mm (21W)</p> <p>FWHM / FWTM 25.0° / 46.0°</p> <p>Efficiency 81 %</p> <p>Peak intensity 3.6 cd/m</p> <p>LEDs/each optic 1</p> <p>Light colour Tunable White</p> <p>Required components: Bender Wirth: 632b Hekla XL</p>		
<p></p> <p>LED Vesta DTW 15mm (33W)</p> <p>FWHM / FWTM 26.0° / 48.0°</p> <p>Efficiency 81 %</p> <p>Peak intensity 3.4 cd/m</p> <p>LEDs/each optic 1</p> <p>Light colour Tunable White</p> <p>Required components: Bender Wirth: 632b Hekla XL</p>		

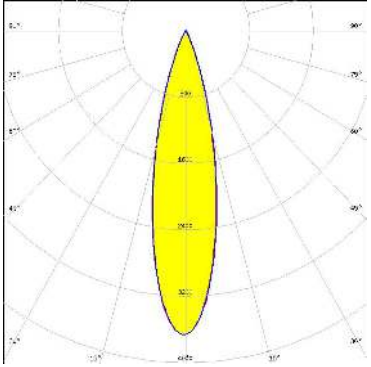
OPTICAL RESULTS (MEASURED):

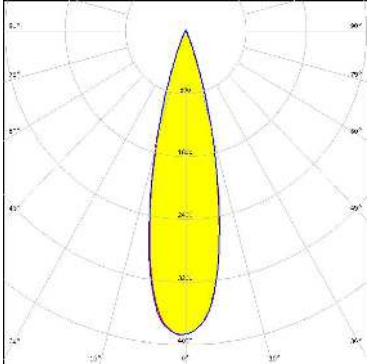
<p></p> <p>LED Vesta DTW 9mm (4W/6W/12W) FWHM / FWTM 27.0° / 43.0° Efficiency 83 % Peak intensity 3.7 cd/lm LEDs/each optic 1 Light colour White Required components: Bender Wirth: 652b Hekla</p>		
<p>CITIZEN</p> <p>LED CLL02x/CLU02x (LES10) FWHM / FWTM 25.0° / 42.0° Efficiency 83 % Peak intensity 3.9 cd/lm LEDs/each optic 1 Light colour White Required components: F17435_HEKLA-G2-C</p>		
<p>CITIZEN</p> <p>LED CLL03x/CLU03x FWHM / FWTM 25.0° / 45.0° Efficiency 82 % Peak intensity 3.7 cd/lm LEDs/each optic 1 Light colour White Required components: F17438_HEKLA-G2-I</p>		
<p></p> <p>LED CMA1516 FWHM / FWTM 26.0° / 42.0° Efficiency 83 % Peak intensity 3.9 cd/lm LEDs/each optic 1 Light colour White Required components: F17436_HEKLA-G2-D</p>		

OPTICAL RESULTS (MEASURED):

CREE LED

LED CMA1825
 FWHM / FWTM 25.0° / 44.0°
 Efficiency 83 %
 Peak intensity 3.8 cd/m
 LEDs/each optic 1
 Light colour White
 Required components:
 F15254_HEKLA-SOCKET-B

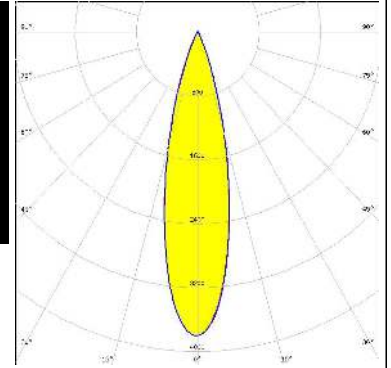

CREE LED

LED CMT14xx
 FWHM / FWTM 26.0° / 42.0°
 Efficiency 83 %
 Peak intensity 3.8 cd/m
 LEDs/each optic 1
 Light colour White
 Required components:
 F17435_HEKLA-G2-C

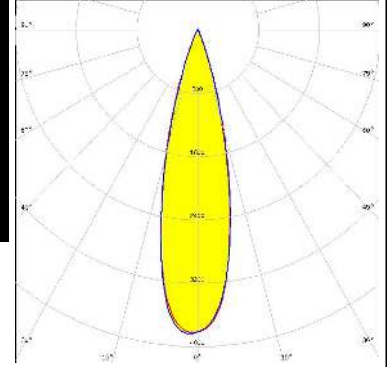

CREE LED

LED CMT19xx
 FWHM / FWTM 24.0° / 45.0°
 Efficiency 81 %
 Peak intensity 3.6 cd/m
 LEDs/each optic 1
 Light colour White
 Required components:
 F17438_HEKLA-G2-I

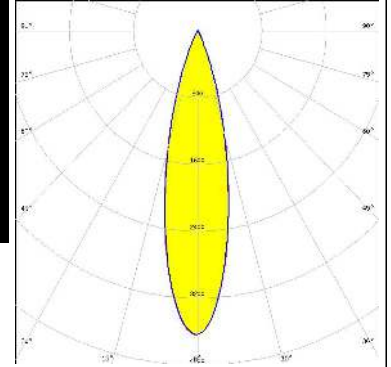





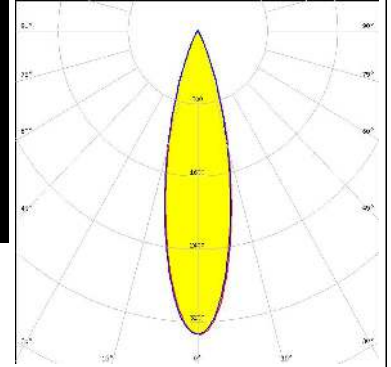

CREE LED

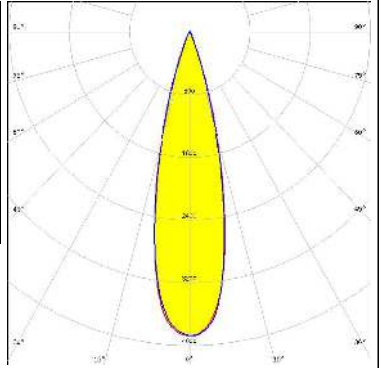
LED CMU15xx
 FWHM / FWTM 26.0° / 47.0°
 Efficiency 79 %
 Peak intensity 3.3 cd/m
 LEDs/each optic 1
 Light colour White
 Required components:
 F17438_HEKLA-G2-I

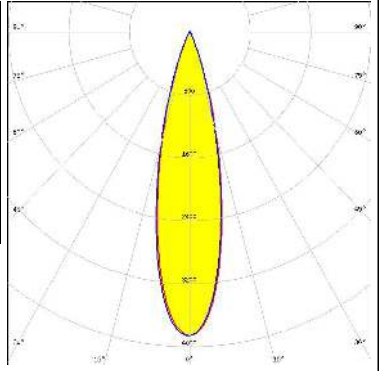

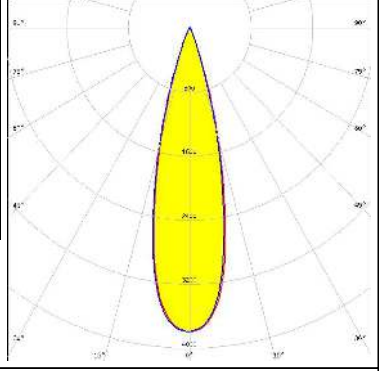
OPTICAL RESULTS (MEASURED):

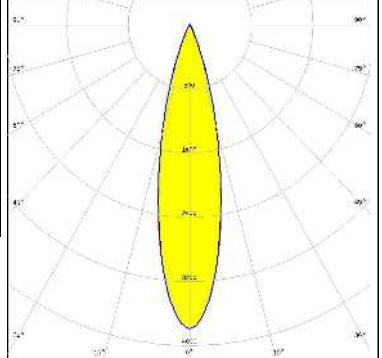
<p>LUMILEDS</p> <p>LED LUXEON CoB 1202/1203</p> <p>FWHM / FWTM 26.0° / 42.0°</p> <p>Efficiency 82 %</p> <p>Peak intensity 3.9 cd/m</p> <p>LEDs/each optic 1</p> <p>Light colour White</p> <p>Required components: F17437_HEKLA-G2-H</p>		
<p>NICHIA</p> <p>LED COB L-Type (LES 11)</p> <p>FWHM / FWTM 24.0° / 43.0°</p> <p>Efficiency 82 %</p> <p>Peak intensity 3.9 cd/m</p> <p>LEDs/each optic 1</p> <p>Light colour White</p> <p>Required components: F17437_HEKLA-G2-H</p>		
<p>NICHIA</p> <p>LED COB L-Type (LES 9)</p> <p>FWHM / FWTM 26.0° / 42.0°</p> <p>Efficiency 82 %</p> <p>Peak intensity 3.8 cd/m</p> <p>LEDs/each optic 1</p> <p>Light colour White</p> <p>Required components: F17437_HEKLA-G2-H</p>		
<p>NICHIA</p> <p>LED COB S-Type (LES 7)</p> <p>FWHM / FWTM 24.0° / 45.0°</p> <p>Efficiency 81 %</p> <p>Peak intensity 3.8 cd/m</p> <p>LEDs/each optic 1</p> <p>Light colour White</p> <p>Required components: F17438_HEKLA-G2-I</p>		

OPTICAL RESULTS (MEASURED):

PHILIPS

LED Fortimo SLM L09 CoB
 FWHM / FWTM 25.0° / 42.0°
 Efficiency 82 %
 Peak intensity 3.9 cd/m
 LEDs/each optic 1
 Light colour White
 Required components:
 F17437_HEKLA-G2-H

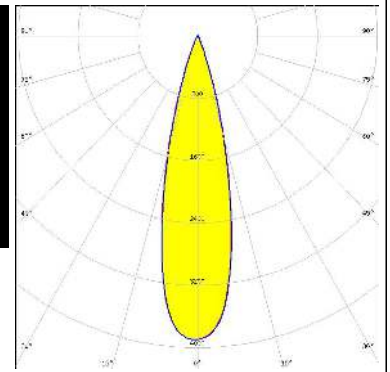

SAMSUNG

LED LC016D / LC019D / LC026D / LC033D
 FWHM / FWTM 26.0° / 47.0°
 Efficiency 81 %
 Peak intensity 3.4 cd/m
 LEDs/each optic 1
 Light colour White
 Required components:
 F17438_HEKLA-G2-I

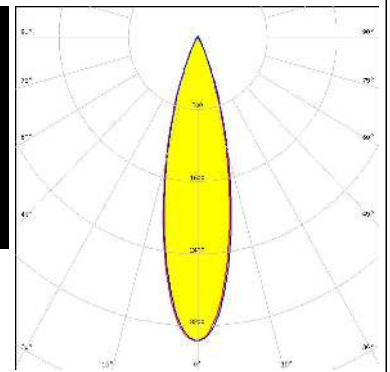

SAMSUNG

LED LC030C/040C G2
 FWHM / FWTM 25.0° / 45.0°
 Efficiency 82 %
 Peak intensity 3.9 cd/m
 LEDs/each optic 1
 Light colour White
 Required components:
 F17438_HEKLA-G2-I

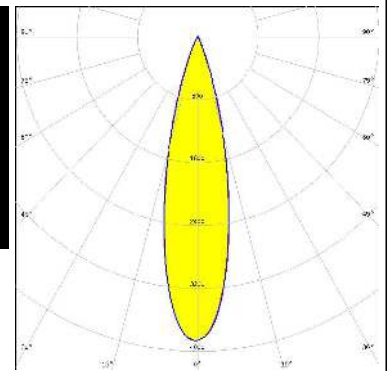
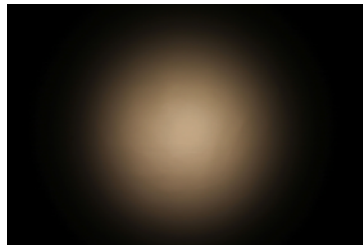

SEUL SEMICONDUCTOR
 LED MJT COB LES 14.5
 FWHM / FWTM 25.0° / 46.0°
 Efficiency 81 %
 Peak intensity 3.5 cd/m
 LEDs/each optic 1
 Light colour White
 Required components:
 F17438_HEKLA-G2-I

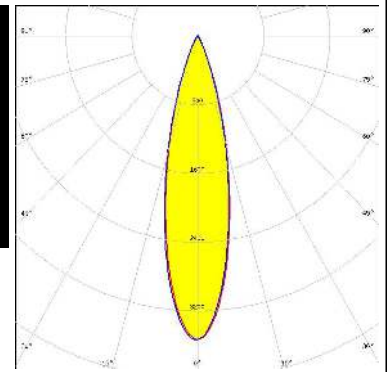
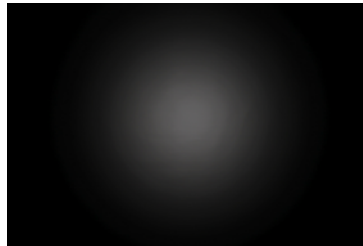

OPTICAL RESULTS (MEASURED):

TRIDONIC

LED SLE G7 LES09
FWHM / FWTM 26.0° / 42.0°
Efficiency 83 %
Peak intensity 3.9 cd/m
LEDs/each optic 1
Light colour White
Required components:
F17435_HEKLA-G2-C

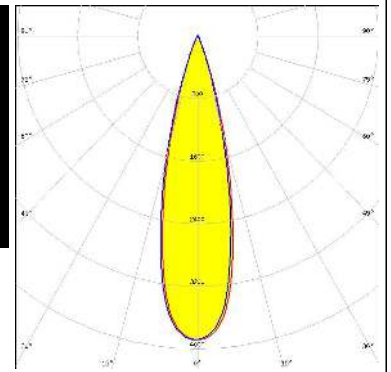





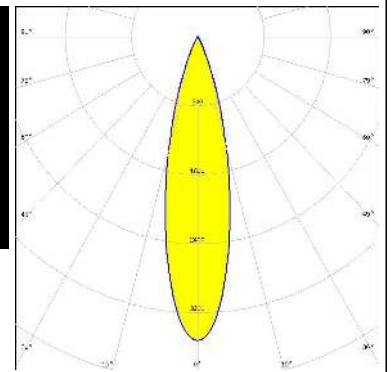

TRIDONIC

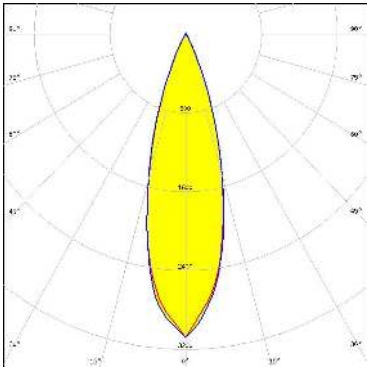
LED SLE G7 LES15
FWHM / FWTM 25.0° / 46.0°
Efficiency 81 %
Peak intensity 3.5 cd/m
LEDs/each optic 1
Light colour White
Required components:
F17438_HEKLA-G2-I

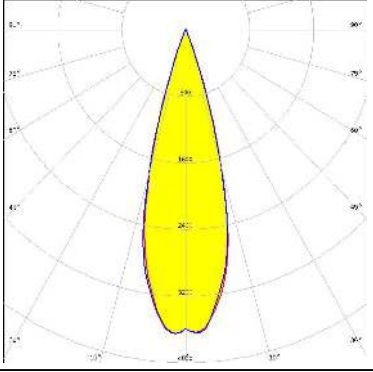

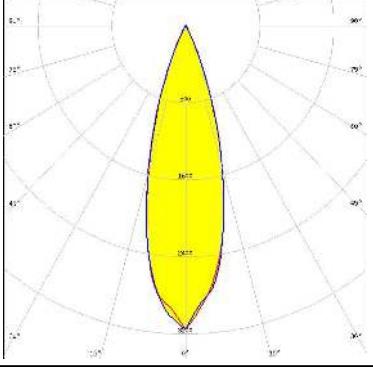
OPTICAL RESULTS (SIMULATED):

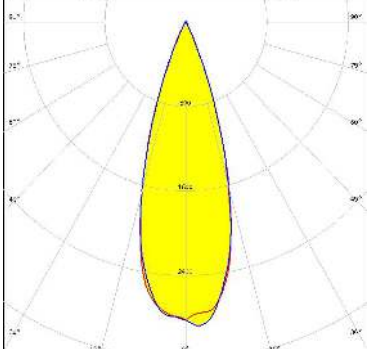
<p></p> <p>LED V13 Gen7 FWHM / FWTM 30.0° / 50.0° Efficiency 86 % Peak intensity 3.1 cd/lm LEDs/each optic 1 Light colour White Required components:</p>	
<p></p> <p>LED V6 HD Gen 7 FWHM / FWTM 30.0° / 42.0° Efficiency 86 % Peak intensity 3.7 cd/lm LEDs/each optic 1 Light colour White Required components: F15255_HEKLA-SOCKET-C</p>	
<p></p> <p>LED Vesta TW 13mm (25W) CSP FWHM / FWTM 30.0° / 50.0° Efficiency 86 % Peak intensity 3.2 cd/lm LEDs/each optic 1 Light colour White Required components: C16142_HEKLA-SOCKET-K</p>	
<p></p> <p>LED Vesta TW 9mm (12W) CSP FWHM / FWTM 32.0° / 50.0° Efficiency 87 % Peak intensity 2.9 cd/lm LEDs/each optic 1 Light colour White Required components: C16142_HEKLA-SOCKET-K</p>	

OPTICAL RESULTS (SIMULATED):

CITIZEN

LED CLU712/713
 FWHM / FWTM 28.0° / 42.0°
 Efficiency 84 %
 Peak intensity 3.8 cd/lm
 LEDs/each optic 1
 Light colour White
 Required components:
 F17438_HEKLA-G2-I

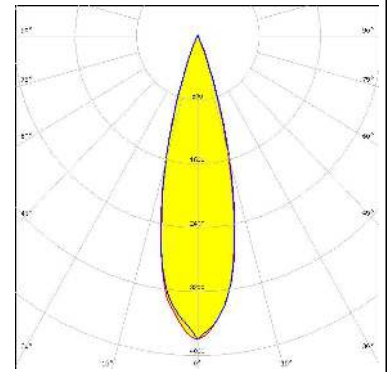

CREE LED

LED CHA0304
 FWHM / FWTM 30.0° / 41.0°
 Efficiency 85 %
 Peak intensity 3.8 cd/lm
 LEDs/each optic 1
 Light colour White
 Required components:
 F17435_HEKLA-G2-C

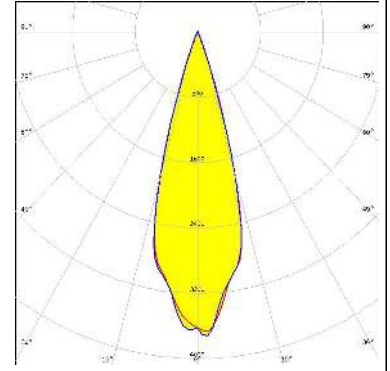

CREE LED

LED CHA0410
 FWHM / FWTM 30.0° / 41.0°
 Efficiency 85 %
 Peak intensity 3.9 cd/lm
 LEDs/each optic 1
 Light colour White
 Required components:
 F17435_HEKLA-G2-C

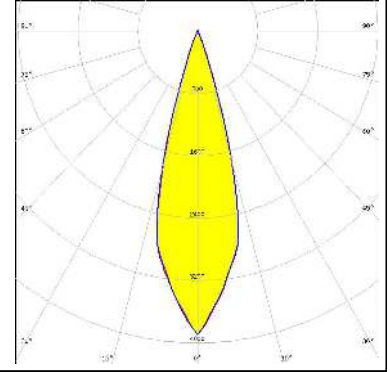

CREE LED

LED CHA0612
 FWHM / FWTM 30.0° / 42.0°
 Efficiency 85 %
 Peak intensity 3.7 cd/lm
 LEDs/each optic 1
 Light colour White
 Required components:
 F17435_HEKLA-G2-C

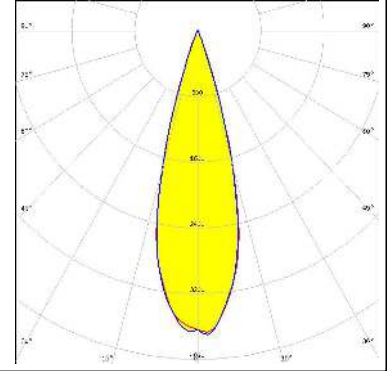

OPTICAL RESULTS (SIMULATED):

<p>CREE ⇄ LED</p> <p>LED: CMU10xx FWHM / FWTM: 27.0° / 44.0° Efficiency: 85 % Peak intensity: 3.9 cd/lm LEDs/each optic: 1 Light colour: White Required components: F17435_HEKLA-G2-C</p>	
<p>CREE ⇄ LED</p> <p>LED: CXA/B 13xx FWHM / FWTM: 30.0° / 43.0° Efficiency: 85 % Peak intensity: 3.6 cd/lm LEDs/each optic: 1 Light colour: White Required components: F17439_HEKLA-G2-J</p>	
<p>CREE ⇄ LED</p> <p>LED: CXA/B 15xx FWHM / FWTM: 28.0° / 42.0° Efficiency: 84 % Peak intensity: 3.8 cd/lm LEDs/each optic: 1 Light colour: White Required components: F17436_HEKLA-G2-D</p>	
<p>CREE ⇄ LED</p> <p>LED: CXA/B 1830 FWHM / FWTM: 26.0° / 46.0° Efficiency: 83 % Peak intensity: 3.6 cd/lm LEDs/each optic: 1 Light colour: White Required components: Bender Wirth: 637b Hekla</p>	

OPTICAL RESULTS (SIMULATED):

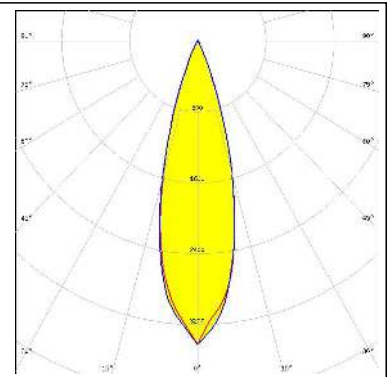
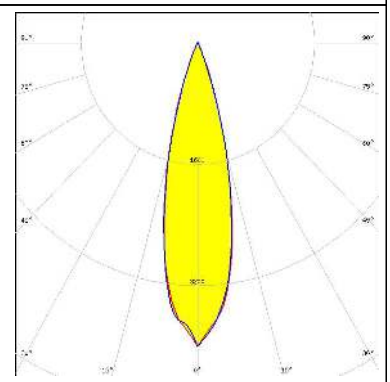
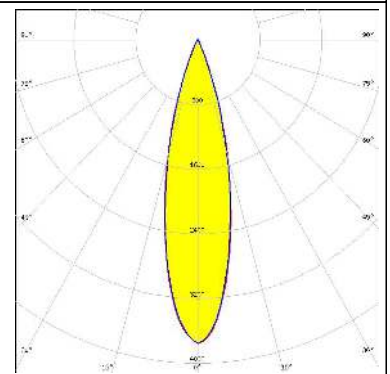
<p>NICHIA</p> <p>LED NVCWJ024Z-V1MT: COB J-Type Tunable White</p> <p>FWHM / FWTM 28.0° / 47.0°</p> <p>Efficiency 85 %</p> <p>Peak intensity 3.4 cd/lm</p> <p>LEDs/each optic 1</p> <p>Light colour White</p> <p>Required components: C16142_HEKLA-SOCKET-K Bender Wirth: 498 Typ L8 HV</p>	
<p>SAMSUNG</p> <p>LED LC003D / LC006D / LC009D / LC013D</p> <p>FWHM / FWTM 26.0° / 43.0°</p> <p>Efficiency 84 %</p> <p>Peak intensity 4 cd/lm</p> <p>LEDs/each optic 1</p> <p>Light colour White</p> <p>Required components: F17435_HEKLA-G2-C</p>	
<p>TRIDONIC</p> <p>LED SLE G7 LES13</p> <p>FWHM / FWTM 26.0° / 46.0°</p> <p>Efficiency 83 %</p> <p>Peak intensity 3.8 cd/lm</p> <p>LEDs/each optic 1</p> <p>Light colour White</p> <p>Required components: F17438_HEKLA-G2-I</p>	

GENERAL INFORMATION:

NOTE: The typical beam angle will be changed by different color, chip size and chip position tolerance. The typical total beam angle is the full angle measured where the luminous intensity is half of the peak value.

Due to use of high power COB's with this product, special attention to proper thermal design is highly recommended. LEDiL has no liability for direct, indirect or consecutive damages arising from the LEDiL products being used outside of the recommended temperature range.

MATERIALS:

As part of our continuous research and improvement processes, and to ensure the best possible quality and availability of our products, LEDiL reserves the right to change material grades without notice.

PRODUCT DATA USER AGREEMENT AND DISCLAIMER:

The measured data in the provided downloadable LEDiL Product Datasheets and Mechanical 2D-Drawings is rounded and provided as reference for planning. LEDiL Oy's optical specifications have been verified by conducting performance testing of the products in accordance with the company's quality system. The reported data are averaged results of multiple measurements with typical variation. LEDiL Oy reserves the right to without prior notification make changes and improvements to its products.

LEDiL Oy assumes neither warranty, nor guarantee nor any other liability of any kind for the contents and correctness of the provided data. The provided data has been generated with highest diligence but the provided data may in reality not represent the complete possible variation range of all intrinsic parameters. Therefore, in certain cases a deviation from the provided data could occur.

LEDiL Oy reserves the right to undertake technical changes of its products without further notification which could lead to changes in the provided data. LEDiL Oy assumes no liability of any kind for the possible deviation from any provided data or any other damage resulting from the usage of the provided data.

The user agrees to this disclaimer and user agreement with the download or usage of the provided files.

LEDiL Oy

Joensuunkatu 13
FI-24240 SALO
Finland

LEDiL Inc.

228 West Page Street
Suite D
Sycamore IL 60178
USA

Ledil Optics Technology (Shenzhen) Co., Ltd.

405 , Block B
Casic Motor Building
Shenzhen 518057
P.R.CHINA

Local sales and technical support

[www.ledil.com/
where_to_buy](http://www.ledil.com/where_to_buy)

Shipping locations

Salo, Finland
Hong Kong, China

Distribution Partners

[www.ledil.com/
where_to_buy](http://www.ledil.com/where_to_buy)