

CLP0212 Open Frame Power Supply

90 - 264Vac input; 12Vdc output; 200W Output Power



Applications

- Telecommunications equipment
- Embedded Computing
- Storage Systems
- Industrial equipment

Description

In a small 2 x 4 inch footprint, the 12Vdc single-output CLP0212 open frame power supply delivers 80 PLUS Gold energy efficiency. With its small size, the CLP series is specifically designed to handle power challenges associated with tight space and low airflow. Offering a leading 18W/in³ power density in a 1U high, fan-less form factor, the CLP series addresses a broad range of applications in new products from communications, computing and data storage original equipment manufacturers (OEMs). It delivers greater than 90 percent typical power efficiency and full load output at +50°C (122°F) with higher temperature operation possible at derated output. The CLP series utilizes a unique design approach at this power level, leveraging zero voltage switching techniques in conjunction with quasi-resonant power factor correction (PFC) circuits. Protection features include overcurrent (OCP), overvoltage (OVP), and overtemperature (OTP).

* UL is a registered trademark of Underwriters Laboratories, Inc.

† CSA is a registered trademark of Canadian Standards Association.

‡ VDE is a trademark of Verband Deutscher Elektrotechniker e.V.

** ISO is a registered trademark of the International Organization of Standards

Features

- Compact size 50.8 mm x 101.6 mm x 36.1 mm (2 in x 4 in x 1.4 in) with density of 18W/in³
- Universal AC Input Range (90 – 264VAC)
- Output voltage of 12V (adjustable ±5%)
- Maximum output current of 16.7A@ 12Vout (200W)
- Standby output of 5V @ 0.25A
- High efficiency with 80 PLUS® Gold Certification
- Full load capability at 50°C and 1m/s (200LFM) airflow with derating at higher temperatures or lower airflows
- Remote ON/OFF
- Output overcurrent protection (non-latching)
- Overtemperature protection
- Output overvoltage protection
- Up to 12ms of holdup time
- Parallellable with current sharing
- Active power factor corrected input
- Conducted EMI - meets CISPR32 (EN55032) and FCC Class A requirements
- Compliant to RoHS II EU Directive 2011/65/EU and amended Directive (EU) 2015/863.
- Compliant to REACH Directive (EC) No 1907/2006
- UL and cUL approved to UL/CSA62368-1, TUV (EN62368-1), CE Mark (for LVD) and CB Report available
- ISO** 9001 and ISO 14001 certified manufacturing facilities

CLP0212 Open Frame Power Supply

90 - 264Vac input; 12Vdc output; 200W Output Power

Absolute Maximum Ratings

Stresses in excess of the absolute maximum ratings can cause permanent damage to the device. These are absolute stress ratings only, functional operation of the device is not implied at these or any other conditions in excess of those given in the operations sections of the data sheet. Exposure to absolute maximum ratings for extended periods can adversely affect the device reliability.

| Parameter | Device | Min | Max | Unit |
|--|------------------|------|------|------|
| Input Voltage - Continuous | All | 90 | 264 | Vac |
| For up to 10 seconds max. | All | 90 | 275 | Vac |
| Input Voltage – Continuous – CATV Powering trapezoidal waveform (Note: Output power is limited to 100W) | All | 75 | 130 | VRMS |
| Operating Ambient Temperature (see Thermal Considerations section) | All | -25 | 70 | °C |
| | CLP0212FPEX5Z01C | -40‡ | 85* | °C |
| | CLP0212FPEX5Z03C | -40‡ | 85* | °C |
| (in sealed enclosure applications with thermally conductive pad to enclosure, P _{o,max} = 110W) | CLP0212FPEX5Z03C | -40 | 55† | °C |
| Storage Temperature | All | -40 | 85 | °C |
| Humidity (non-condensing) | All | 5 | 95 | % |
| Altitude | All | | 5000 | m |

‡ Startup at -40°C is limited to 80% of maximum load (160W) for all versions.

* Unit is capable of operation up to 85°C ambient for brief periods of time provided humidity is kept below 40%. Sustained operation at 85°C when input voltage is above 230VAC and output power loading is at or near the maximum rated value can degrade reliability of the product.

† Ambient temperature outside the sealed enclosure containing the power supply.

Electrical Specifications

| Parameter | Device | Min | Typ | Max | Unit |
|--|--------|------|---------|------|----------------------|
| Operating Input Voltage | All | 90 | 115/230 | 264 | Vac |
| Input Source Frequency | All | 47 | 50/60 | 63 | Hz |
| Input Current (V _{IN} = 90Vac) | All | | | 4 | A _{RMS} |
| Input Power Factor | All | | 0.95 | | |
| Inrush Transient Current (V _{IN} = 264Vac, T _{amb} = 25°C) | All | | | 100 | A Peak |
| Leakage Current to earth ground (V _{IN} = 264Vac) | All | | | 2 | mA |
| Output Voltage Setpoint | All | | 12 | | Vdc |
| Output Voltage Tolerance (due to set point, temperature variations, load and line regulation) | All | -2 | | 2 | % |
| Output Voltage Adjustment Range | All | 11.4 | | 12.6 | Vdc |
| Output Remote Sense Range | All | | | 250 | mVdc |
| Output Load Regulation | All | | | 1.5 | %Vout |
| Output Line Regulation | All | | | 0.5 | %Vout |
| Output Ripple and Noise – measured with 0.1µF ceramic capacitor in parallel with 10µF tantalum capacitor, at 25°C ¹ Peak-to-peak (20MHz Bandwidth) | All | | | 180 | mV p-p |
| Dynamic Load Response – 50% to 75% load transient, 0.1A/µs slew rate Output voltage deviation Settling Time | All | | | 5% | % |
| | All | | | 500 | µs |
| Output Current | All | 0 | | 16.7 | A _{dc} |
| Output Current Limit Inception | All | | 115 | | % I _{o,max} |

¹ Output ripple is 300mV p-p maximum at -40°C. To reduce further, additional external capacitance needed.

CLP0212 Open Frame Power Supply

90 - 264Vac input; 12Vdc output; 200W Output Power

Electrical Specifications (cont.)

| Parameter | Device | Min | Typ | Max | Unit |
|---|------------------|-----|------|------|------|
| Maximum Output Capacitance | All | | | 5000 | μF |
| Standby Output Voltage | CLP0212FPEX5Z01C | | 5 | | Vdc |
| Standby Output Current | CLP0212FPEX5Z01C | | | 0.25 | Adc |
| Efficiency: $V_{IN} = 230\text{Vac}$, 20% load | All | | 86.8 | | % |
| 50% load | All | | 91.1 | | % |
| 100% load | All | | 89.5 | | % |
| $V_{IN} = 115\text{Vac}$, 20% load | All | | 89.2 | | % |
| 50% load | All | | 90.3 | | % |
| 100% load | All | | 87.1 | | % |
| Holdup Time – $V_{IN} = 115\text{Vac}$, 100% load ² | All | | 10 | | ms |
| $V_{IN} = 230\text{Vac}$, 100% load | All | | 10 | | ms |

Isolation Specifications

| Parameter | Device | Min | Max | Unit |
|-------------------------------------|--------|-----|------|------|
| Isolation Voltage – Input to output | All | | 3000 | Vac |
| Input to safety ground | All | | 1500 | Vac |
| Outputs to safety ground | All | | 50 | Vac |

General Specifications

| Parameter | Device | Symbol | Typ. | Unit |
|--|--------|--------|---------|---------------------|
| Calculated Reliability based on Telcordia SR-332 Issue 2: Method 1 Case 3 ($V_{IN}=230\text{Vac}$, $I_o = 16.7\text{A}$, $T_A = 40^\circ\text{C}$, airflow 200LFM, 90% confidence) | All | FIT | 1,011.9 | $10^3/\text{Hours}$ |
| | | MTBF | 988,276 | Hours |
| Weight | All | | 185 | g |
| | | | 6.5 | oz. |

Feature Specifications

| Parameter | Device | Min | Typ | Max | Unit |
|--|--------|------|-----|-----|------|
| On/Off Signal Interface – signal referenced to GND | | | | | |
| Logic Low (Power Supply ON) | | | | | |
| Input Low Current | All | | | 7 | mA |
| Input Low Voltage | All | | | 1 | V |
| Logic High (Power Supply OFF) | | | | | |
| Input High Current | All | | | 600 | μA |
| Input Voltage | All | | | 5.5 | V |
| Delay from ON/OFF being enabled to start of output voltage rise | All | | | 50 | ms |
| Output Voltage Rise Time (from 10 to 90% of final value) | All | | 5 | | ms |
| Delay from Input being applied to standby output being in regulation | All | | 12 | | ms |
| Delay from Input being applied to all outputs being in regulation | All | | 30 | | ms |
| Output Overvoltage Protection (for main output currents above 0.1A) | All | 13.8 | | 18 | Vdc |

² Holdup time is reduced at cold temperatures

CLP0212 Open Frame Power Supply
 90 - 264Vac input; 12Vdc output; 200W Output Power

Feature Specifications (cont.)

| Parameter | Device | Min | Typ | Max | Unit |
|--|--------|-----|-----|-----|------|
| Input Undervoltage lockout ³ | | | | | |
| Turn-on Threshold (100% load) | All | | 86 | | Vac |
| Turn-off Threshold (100% load) | All | | 82 | | Vac |
| DC OK – open collector, High when output available | | | | | |
| Sink Current | All | | | 4 | mA |
| Maximum Collector Voltage | All | | | 12 | V |

Environmental Specifications

| Parameter | Device | Specification |
|---------------------------------------|--------|--|
| Conducted Emissions | All | CISPR32 (EN55032) Class A with 3dB margin |
| Radiated Emissions | All | CISPR32 (EN55032) to comply with system enclosure |
| ESD | All | IEC 61000-4-2, Level 3 |
| Radiated Immunity | All | IEC 61000-4-3, Level 2* |
| Electrical Fast Transient Common Mode | All | IEC 61000-4-4, Level 3 |
| Surge Immunity | All | IEC 61000-4-5, Level 3 |
| Conducted RF Immunity | All | IEC 61000-4-6, Level 3 |
| Voltage Dips | All | EN61000 4.11, Level 3, Class B, C |
| Input Voltage Dips | All | Output stays within regulation for either ½ cycle interruption or 25% dip from nominal line for 1 second |
| Input Harmonics | All | IEC61000-3-2 |
| Shock and Vibration | All | IPC-9592B |

* Radiated immunity is met when the power supply is tested in a suitable enclosure.

³ The undervoltage lockout thresholds vary with output load current level – decreasing as the load goes down

CLP0212 Open Frame Power Supply

90 - 264Vac input; 12Vdc output; 200W Output Power

Characteristic Curves

The following figures provide typical characteristics for CLP0212 power supply

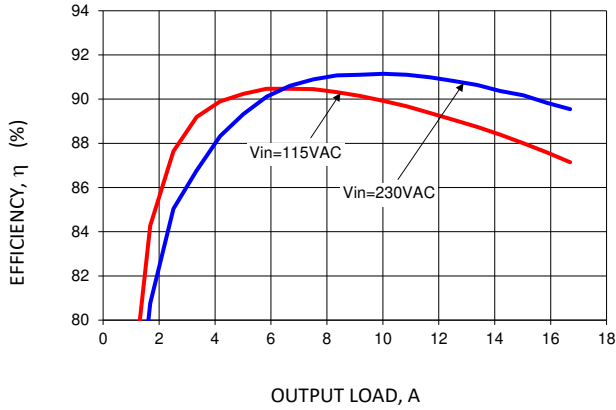

Figure 1. Power Supply Efficiency versus Output Current.

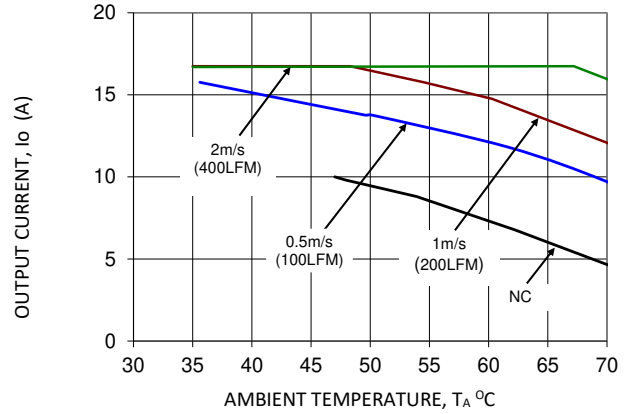

Figure 2. Derating Output Current versus Ambient Temperature and Airflow. Data shown for 115VAC in, at 230VAC in derating is the same or better. For derating at other input voltages, consult the GE Technical representative.

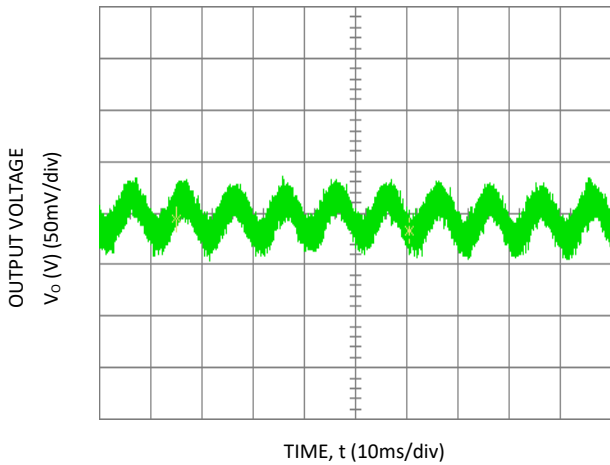

Figure 3. Typical output ripple and noise ($V_{IN} = 230Vac$, 100% load).

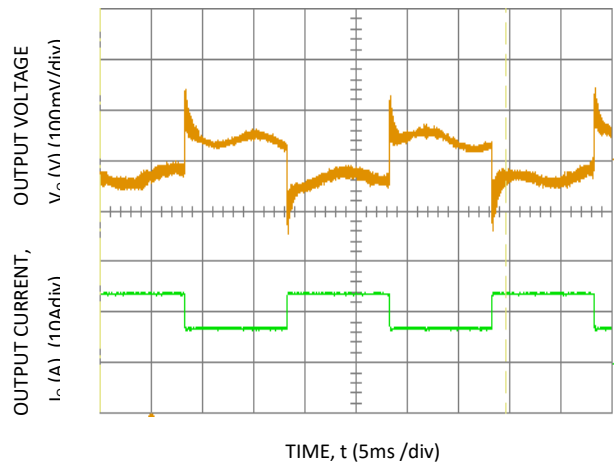

Figure 4. Transient Response to Dynamic Load Change from 50% to 100% at $V_{IN} = 230Vac$.

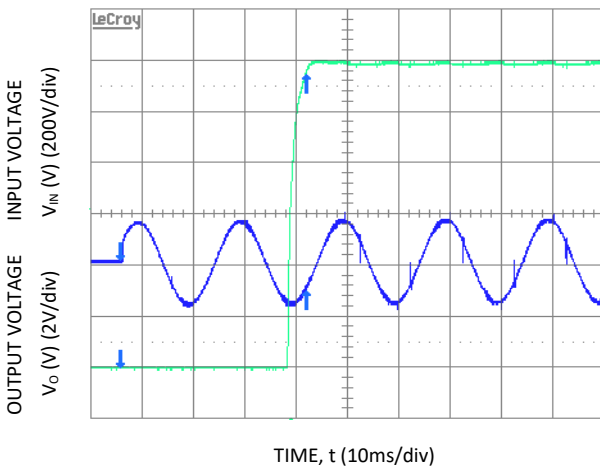

Figure 5. Typical Start-up ($V_{IN} = 115Vac$).

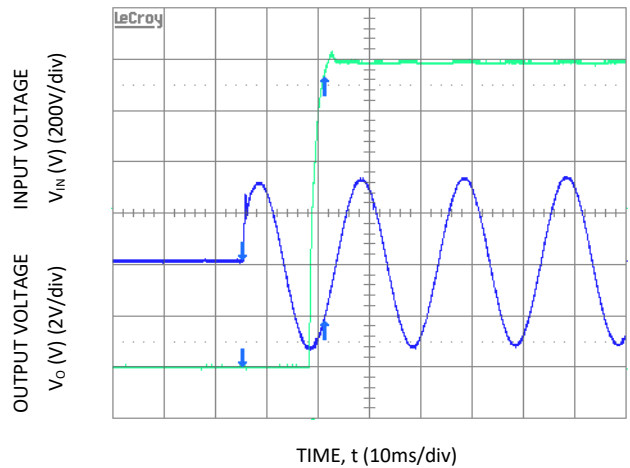

Figure 6. Typical Start-up ($V_{IN} = 230Vac$).

CLP0212 Open Frame Power Supply

90 - 264Vac input; 12Vdc output; 200W Output Power

Characteristic Curves (cont.)

The following figures provide typical characteristics for CLP0212 power supply

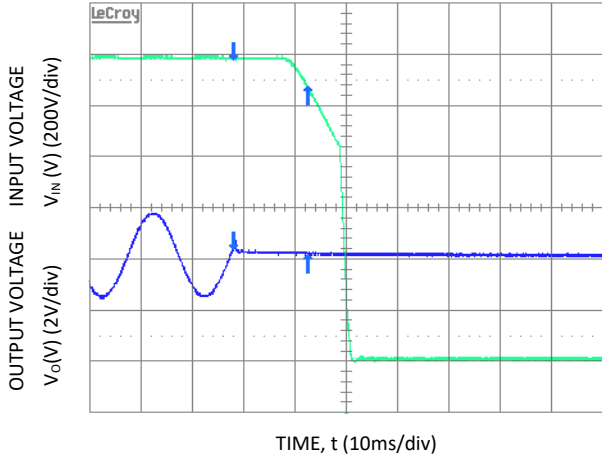

Figure 7. Typical Hold-up waveforms ($V_{in} = 115V$, 100% load).

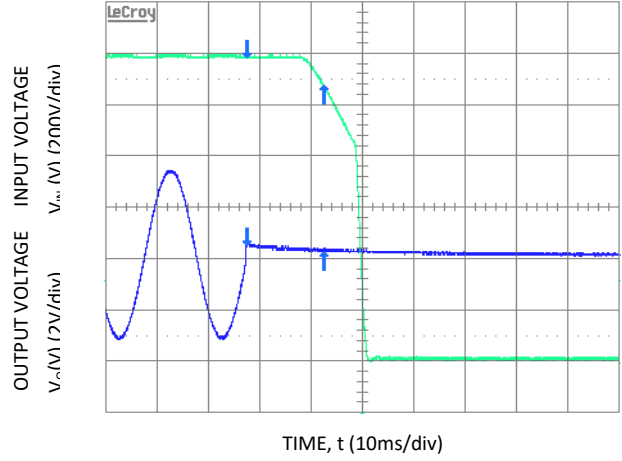

Figure 8. Typical Hold-up waveforms ($V_{in} = 230V$, 100% load).

CLP0212 Open Frame Power Supply

90 - 264Vac input; 12Vdc output; 200W Output Power

Safety Considerations

The CLP0212 power supply is intended for inclusion in other equipment and the installer must ensure that it is in compliance with all the requirements of the end application. This product is only for inclusion by professional installers within other equipment and must not be operated as a stand-alone product. The power supply meets Class 1, IEC62368-1, EN62368-1, with the applicable national deviations which approved by TUV and UL(Recognized Component) C-UL (Canadian Approval by UL).

Feature Descriptions

Standby Power Supply

A standby output in the CLP0212 power supply of 5V, comes on when AC input in the operating range is applied. In the Z02A and Z03A versions of the power supply, the standby output is not accessible.

Remote On/Off

All versions of the CLP0212 power supply except the Z02A and Z03A versions feature a TTL-compatible On/Off control input. The power supply turns ON when the On/Off input goes low, and turns OFF when the input goes high. Note that if the On/Off pin is left unconnected, the power supply main output remains off.

Figure 9 shows the circuit configuration for using the On/Off pin. Either a suitable semiconductor device such as a BJT or FET or a mechanical switch can be used to turn the power supply On and Off. The switch must be capable of handling the On/Off pin current which may be up to 6mA when closed. The switch On voltage drop must also be sufficiently small so that the photo diode inside the power supply is turned ON when the external switch is ON.

Note that the standby output voltage is 5V. If no On/Off control is desired, the On/Off pin can be externally connected to the COM pin and the power supply will automatically turn ON when AC input is within range.

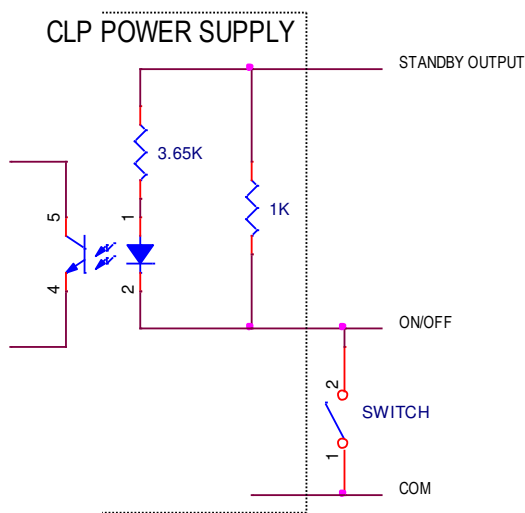

Fig. 9. Schematic showing ON/OFF circuitry.

Output Voltage Adjustment

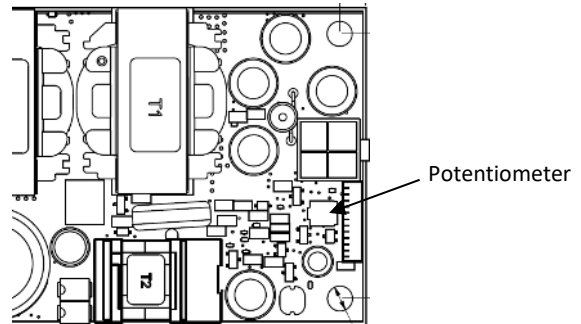

Fig. 10. Diagram showing location of the potentiometer used to adjust the power supply output voltage.

The output voltage can be adjusted between 11.4V and 12.6V using a potentiometer on the power supply. See Fig. 10 for a diagram showing location of the potentiometer.

Remote Sense

The power supply has both positive and negative remote sense connections that can be connected to the positive and negative rails of the main output near the load. Care should be taken in routing the sense lines to ensure that noise is not picked up or that additional filtering elements that affect the stability of the power supply are not used. The power supply will operate without the remote sense connections being made, however if remote sense near the load is not used it is recommended that the remote sense lines be connected directly to the main output terminals.

Overcurrent Protection

To provide protection in a fault condition (output overload), the power supply is equipped with internal current-limiting circuitry and can endure current limiting continuously. At the point of current-limit inception, the unit enters hiccup mode. The power supply operates normally once the output current is brought back into its specified range.

Overvoltage Protection

Overvoltage protection is a feature of the CLP0212 power supply that protects both the load and the power supply from an output overvoltage condition. When an overvoltage occurs, the power supply shuts down and goes into hiccup mode until the overvoltage condition is removed. It is not necessary to recycle the input to restart the power supply when this protection is activated.

Overtemperature Protection

The CLP0212 also features overtemperature protection in order to provide additional protection in a fault condition. The power supply is equipped with a thermal shutdown circuit which detects excessive internal temperatures and shuts the unit down. Once the power supply goes into overtemperature shutdown, it will cool before attempting to restart. The overtemperature protection circuit will typically activate when

CLP0212 Open Frame Power Supply

90 - 264Vac input; 12Vdc output; 200W Output Power

the unit is operated at 200W output with an ambient temperature of 60°C and 1m/s (200LFM) airflow.

Note: Under Natural Convection cooling conditions, the maximum load is restricted to 100W as OTP will be triggered at higher loads.

Input Undervoltage Lockout

At input voltages below the input undervoltage lockout limit, power supply operation is disabled. The power supply will begin to operate at an input voltage above the undervoltage lockout turn-on threshold. Note that the undervoltage lockout limits are load dependent and the power supply turns ON and can operate at much lower input voltage levels when at light or no load.

DC OK

The CLP0212 provides a DC OK signal that indicates when the output has come up and is in regulation. This is an open-collector type signal that goes high when the output is available and within regulation.

Power Good LED

A green LED (located next to HDR3) illuminates when the main output voltage is above 10V.

Paralleling/Load Share

This power supply can be paralleled to provide larger load currents than can be delivered from a single power supply. Up to four power supplies may be paralleled. Paralleling is accomplished by connecting the Current Share signals of multiple power supplies together. At load current levels above 20%, the output currents of multiple power supplies will be within $\pm 5\%$ of the full load value.

If remote sense is used when paralleling is employed, the remote sense connection points should be common to both power supplies.

For applications where redundancy among paralleled power supplies is desired, ORing diodes or other active ORing circuitry needs to be connected in series with each output.

Thermal Considerations

The power supply can be operated in a variety of thermal environments; however sufficient cooling should be provided to ensure reliable operation.

Considerations include ambient temperature, airflow, power supply dissipation and the need for increased reliability. A reduction in the operating temperature of the power supply will result in increased reliability. The thermal data presented here is based on measurements taken in a wind tunnel.

Heat Transfer via Convection

Increased airflow through the power supply enhances the heat transfer via convection. Figure 11 shows the preferred airflow direction. Contact your GE Energy technical representative for derating information in other airflow directions.

CLP0212 Open Frame Power Supply
 90 - 264Vac input; 12Vdc output; 200W Output Power

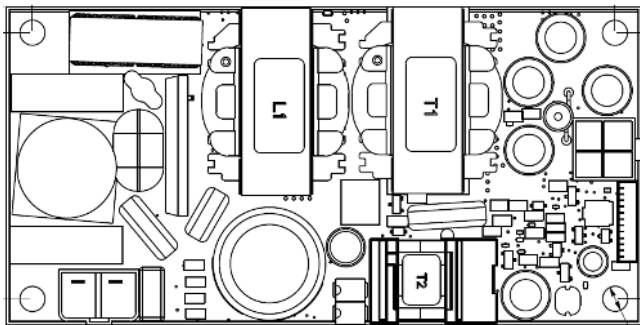

Fig. 11. Preferred airflow direction for cooling.

Operation In a Sealed Enclosure

The CLP0212 power supply can also be operated in a sealed enclosure provided proper means for removing heat from the power supply are used. Figure 12 shows an arrangement where a thermally conductive pad is used to transfer heat from the bottom of the power supply into the enclosure. Under such conditions, the power supply is capable of reduced power operation as shown in Table 1. Note that the Ambient Temperature shown in Table 1 is that outside the sealed enclosure, the CLP0212 may see higher ambient temperatures.

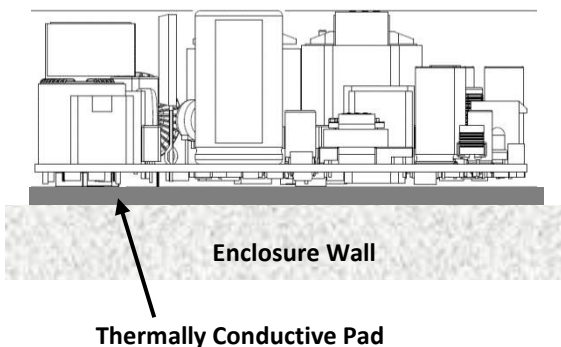

Fig. 12. Example arrangement of the CLP0212 for sealed enclosure applications.

Table 1. Output Power Capability when the CLP0212 is operated in a sealed enclosure with thermal pad for conduction cooling.

| Ambient Temperature (°C) | Max. Output Power (W) |
|--|-----------------------|
| 25 | 170 |
| 40 | 150 |
| 55 | 110 |
| 55 (CATV Powering Input Voltage Waveform) | 100 |

CLP0212 Open Frame Power Supply

90 - 264Vac input; 12Vdc output; 200W Output Power

Mechanical Outline (CLP0212FPEX5Z01C)

Dimensions are in millimeters.
 Tolerances: x.x mm ± 0.5mm [unless otherwise indicated]
 x.xx mm ± 0.25mm

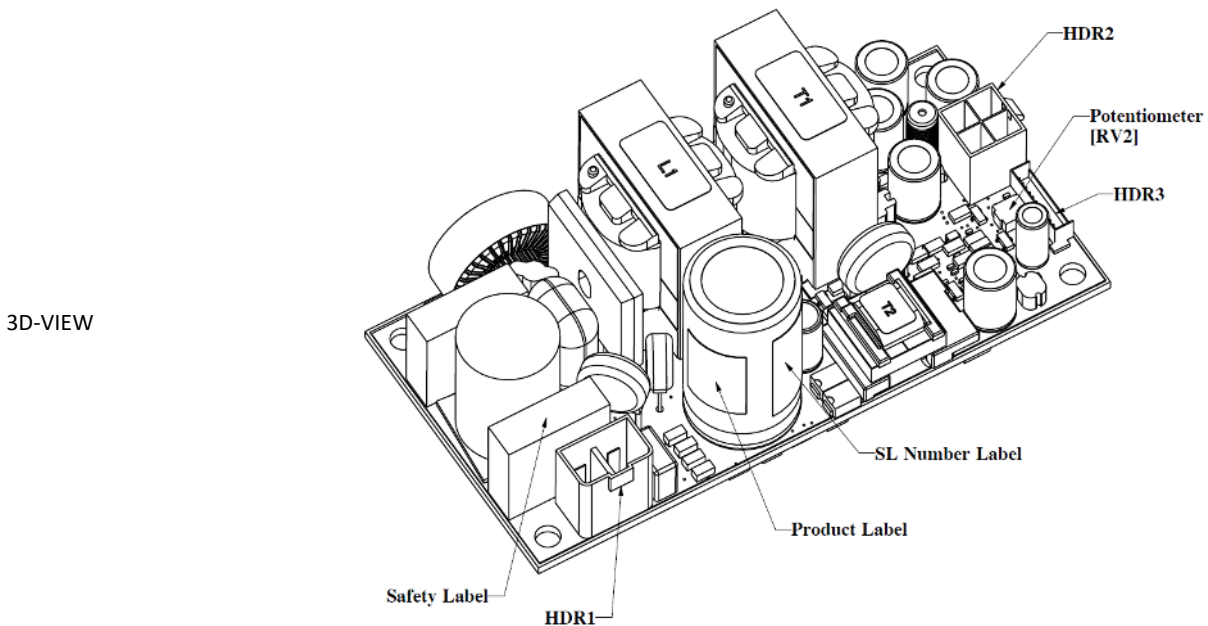
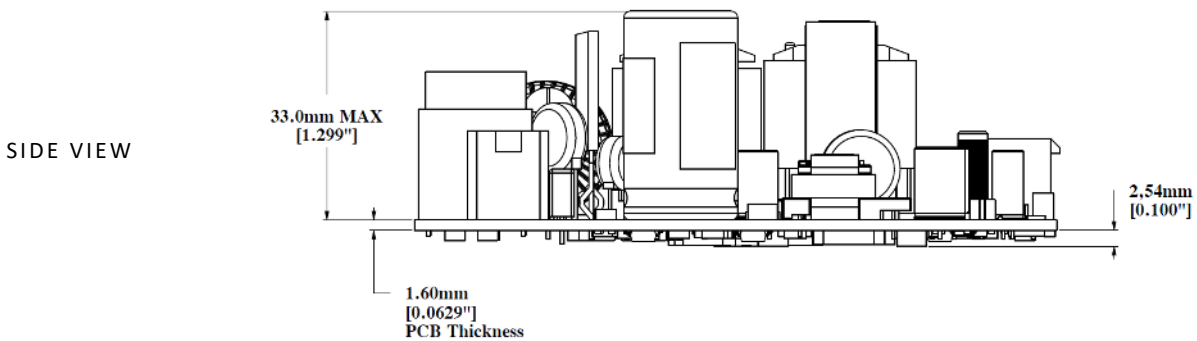
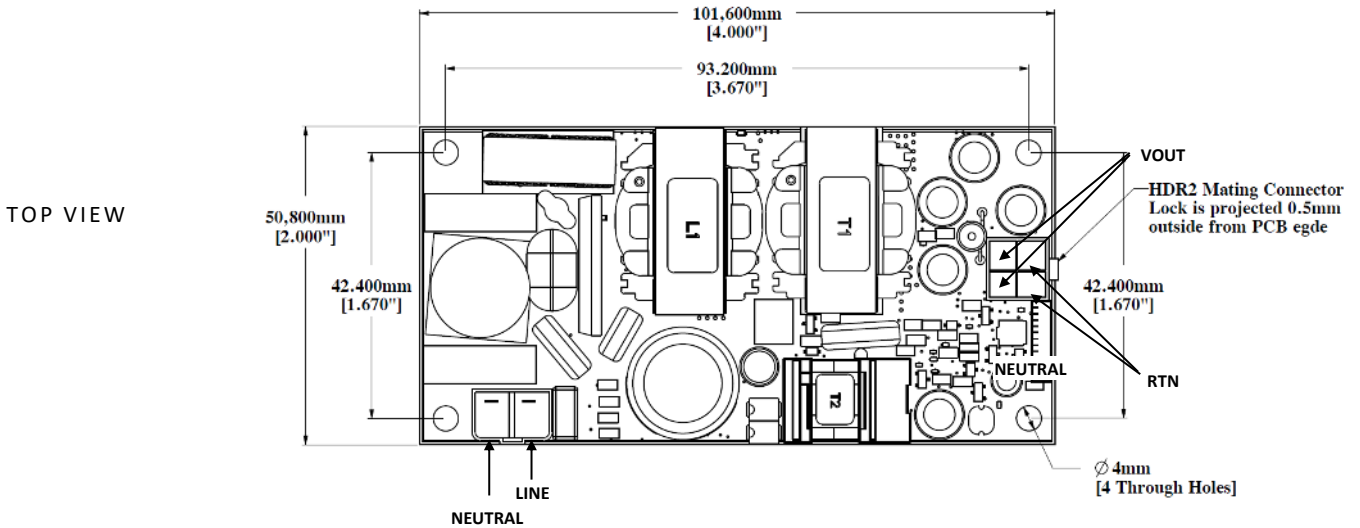

CLP0212 Open Frame Power Supply

90 - 264Vac input; 12Vdc output; 200W Output Power

Mechanical Outline - CLP0212FPEX5Z03C

Dimensions are in millimeters.
 Tolerances: x.x mm ± 0.5mm [unless otherwise indicated]
 x.xx mm ± 0.25mm

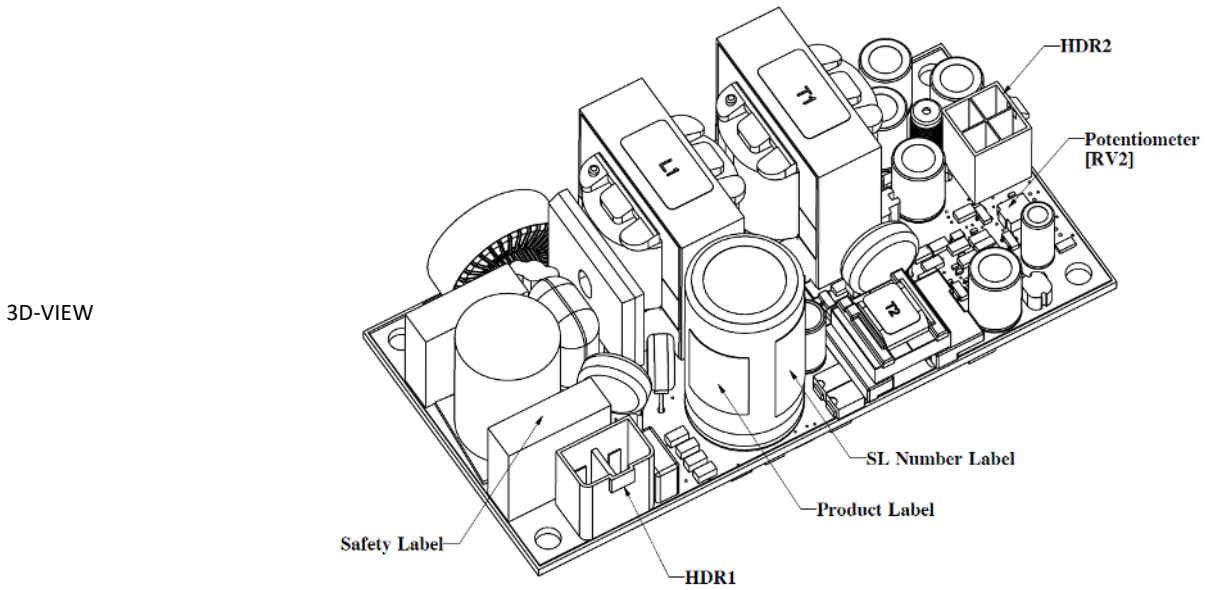
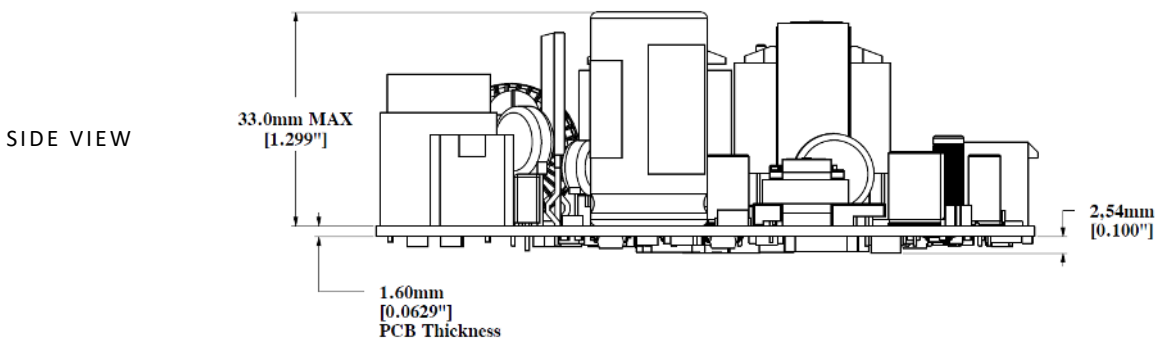
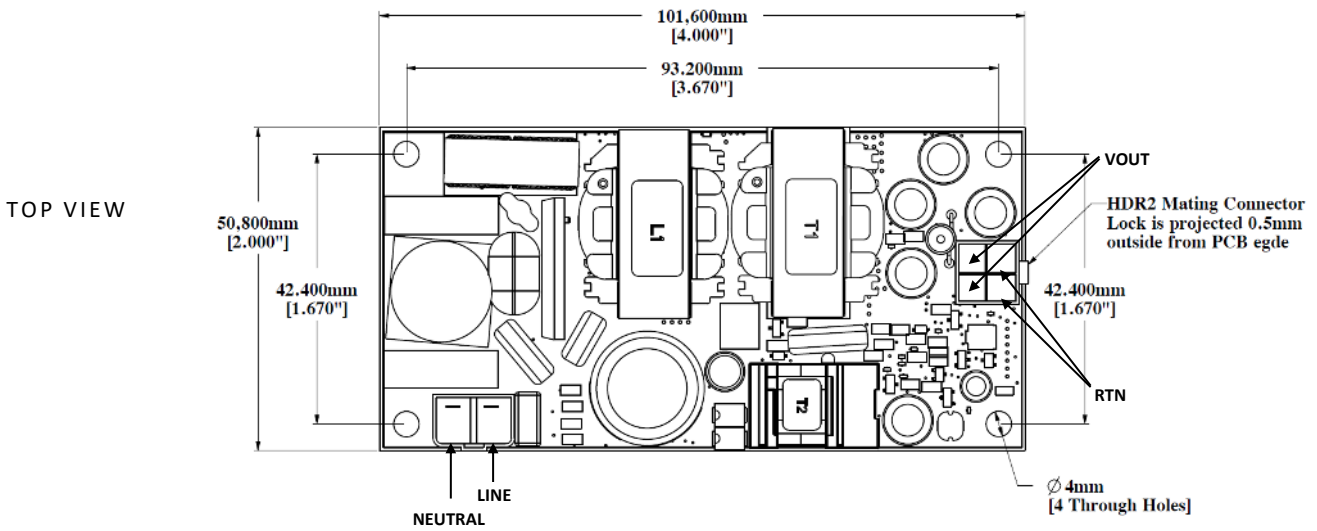

CLP0212 Open Frame Power Supply

90 - 264Vac input; 12Vdc output; 200W Output Power

Connector Information

| Connector | Connector on Power Supply | Mating Connector |
|----------------------------|-------------------------------------|-------------------------------------|
| AC Input Connector (HDR1) | 5-1376382-1 from Tyco or equivalent | 1376388-1 from Tyco or equivalent |
| DC Output Connector (HDR2) | 39-28-1043 from Molex or equivalent | 39-01-2040 from Molex or equivalent |
| Signal Connector** (HDR3) | 53047-0810 from Molex or equivalent | 51021-0800 from Molex or equivalent |

Pinout Information

| AC Input Connector (HDR1) | | DC Output Connector (HDR2) | | Signal Connector ** (HDR3) | |
|---------------------------|---------|----------------------------|-----|----------------------------|---------------------|
| Pin 1 | Line | Pin 1 | VO | Pin 1 | Current Sense |
| Pin 2 | Neutral | Pin 2 | VO | Pin 2 | +S (Remote Sense +) |
| | | Pin 3 | RTN | Pin 3 | -S (Remote Sense -) |
| | | Pin 4 | RTN | Pin 4 | Remote On/Off |
| | | | | Pin 5 | DC-OK (Output OK) |
| | | | | Pin 6 | COM (Output Return) |
| | | | | Pin 7 | COM (Output Return) |
| | | | | Pin 8 | Standby Output |

** Note: Signal Connector HD3 is not present in Z03C version.

CLP0212 Open Frame Power Supply

90 - 264Vac input; 12Vdc output; 200W Output Power

Ordering Information

Please contact your GE Sales Representative for pricing, availability and optional features.

Table 2. Device Codes

| Device Code | Input Voltage Range | Output Voltage | Output Current | On/Off Control | Standby Supply | Temperature Range | Comcode |
|------------------|---------------------|----------------|----------------|----------------|----------------|-------------------|-----------|
| CLP0212FPEX5Z01C | 90 – 264Vac | 12.0Vdc | 16.7A | Negative Logic | 5V@0.25A | -40 to 70°C | 150038518 |
| CLP0212FPEX5Z03C | 90 – 264Vac | 12.0Vdc | 16.7A | Absent | Not accessible | -40 to 70°C | 150038520 |

Contact Us

For more information, call us at

USA/Canada:

+1 888 546 3243, or +1 972 244 9288

Asia-Pacific:

+86-21-53899666

Europe, Middle-East and Africa:

+49.89.878067-280

Go.ABB/Industrial

