

Features

- 3-State output
- 3V and 5V input compatible
- Clocking speeds up to 10 MHz
- 20ns Switching/delay time
- 2A Peak drive
- Low, matched output impedance — 5Ω
- Low quiescent current — 2.5mA
- Wide operating voltage — 4.5V-16V

Applications

- Parallel bus line drivers
- EPROM and PROM programming
- Motor controls
- Charge pumps
- Sampling circuits
- Pin drivers
- Bridge circuits

Ordering Information

Part No.	Package	Tape & Reel	Outline #
EL7232CN	PDIP-8	-	MDP0031
EL7232CS	SO-8	-	MDP0027
EL7232CS-T7	SO-8	7 in	MDP0027
EL7232CS-T13	SO-8	13 in	MDP0027

General Description

The EL7232C 3-state drivers are particularly well suited for ATE and microprocessor based applications. The low quiescent power dissipation makes this part attractive in battery applications. The 2A peak drive capability, makes the EL7232C an excellent choice when driving high speed capacitive lines, as well. The input circuitry provides level shifting from TTL levels to the supply rails. The EL7232C is available in 8-pin PDIP and 8-lead SO packages.

Connection Diagrams

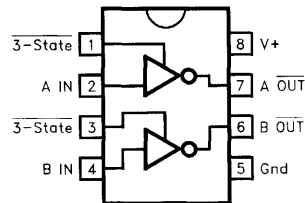

Manufactured under U.S. Patent Nos. 5,334,883, #5,341,047

Absolute Maximum Ratings ($T_A = 25^\circ\text{C}$)

Supply (V+ to Gnd)	16.5V	Operating Junction Temperature	125°C
Input Pins	-0.3V to +0.3V above V+	Power Dissipation	
Combined Peak Output Current	4A	SOIC	570mW
Storage Temperature Range	-65°C to +150°C	PDIP	1050mW
Ambient Operating Temperature	-40°C to +85°C		

Important Note:

All parameters having Min/Max specifications are guaranteed. Typ values are for information purposes only. Unless otherwise noted, all tests are at the specified temperature and are pulsed tests, therefore: $T_J = T_C = T_A$

DC Electrical Characteristics

$T_A = 25^\circ\text{C}$, $V = 15\text{V}$ unless otherwise specified

Parameter	Description	Test Conditions	Min	Typ	Max	Units	
Input	V_{IH}	Logic "1" Input Voltage	2.4			V	
	I_{IH}	Logic "1" Input Current	@V+	0.1	10	μA	
	V_{IL}	Logic "0" Input Voltage			0.8	V	
	I_{IL}	Logic "0" Input Current	@0V		0.1	10	μA
	V_{HVS}	Input Hysteresis			0.3	V	
Output	R_{OH}	Pull-Up Resistance	$I_{OUT} = -100\text{mA}$	3	6	Ω	
	R_{OL}	Pull-Down Resistance	$I_{OUT} = +100\text{mA}$	4	6	Ω	
	I_{OFF}	3-State Output Leakage	$V_{OUT} = V+$ $V_{OUT} = 0\text{V}$	0.2		10	μA
	I_{PK}	Peak Output Current	Source Sink		2.0 2.0		A
	I_{DC}	Continuous Output Current	Source/Sink	100			mA
Power Supply	I_S	Power Supply Current	Inputs High		1	2.5	mA
	V_S	Operating Voltage		4.5		16	V

AC Electrical Characteristics

$T_A = 25^\circ\text{C}$, $V = 15\text{V}$ unless otherwise specified

Parameter	Description	Test Conditions	Min	Typ	Max	Units	
Switching Characteristics	t_R	Rise Time	$C_L = 500\text{pF}$ $C_L = 1000\text{pF}$	7.5 10		ns	
	t_F	Fall Time	$C_L = 500\text{pF}$ $C_L = 1000\text{pF}$	10 13	20	ns	
	t_{D-ON}	Turn-On Delay Time			18	25	ns
	t_{D-OFF}	Turn-Off Delay Time			20	25	ns

Truth Table

3-State	Input	Output
1	0	1
1	1	0
0	0	Open
0	1	Open

EL7232C

2-Ch, High-Speed, High-Current Line Driver w/3-State

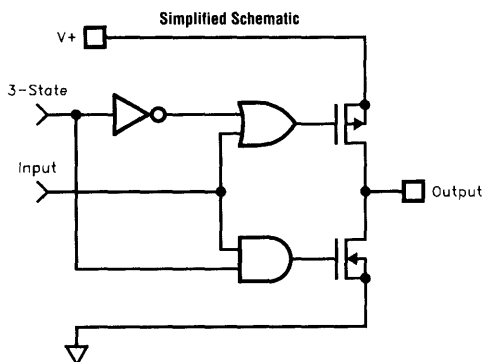
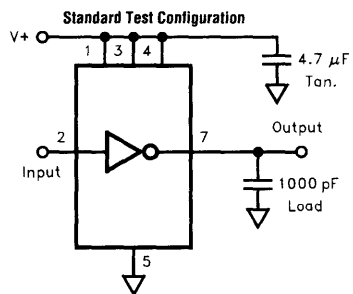
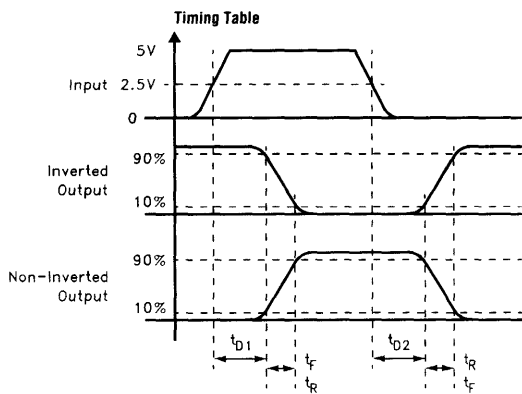

2-Ch, High-Speed, High-Current Line Driver w/3-State

Typical Performance Curves

Max Power/Derating Curves

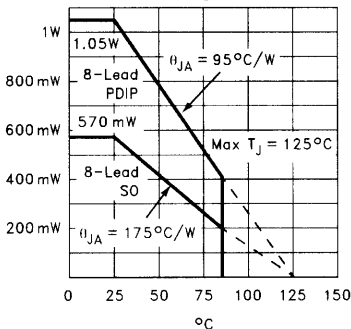

Switch Threshold vs Supply Voltage

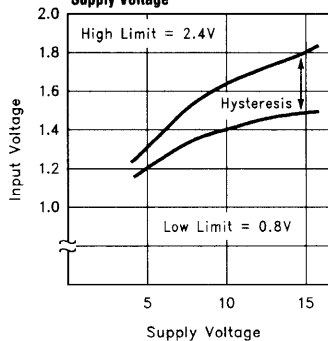

Input Current vs Voltage

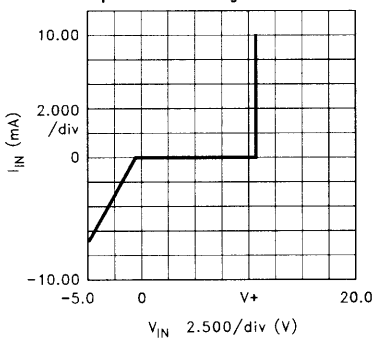

Peak Drive vs Supply Voltage

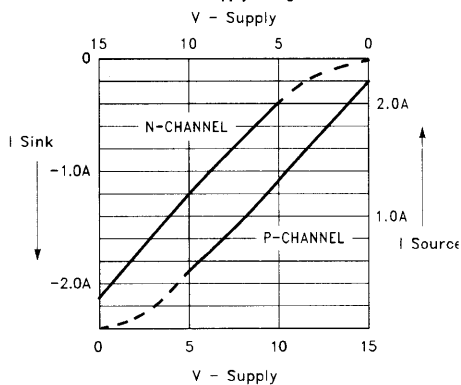

Quiescent Supply Current

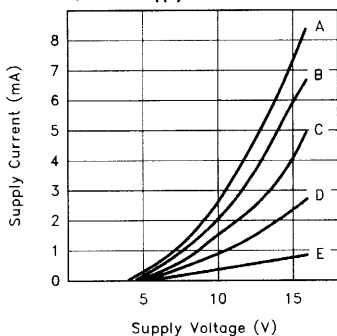

- CASE:
- A ALL INPUTS GND
 - B 3 INPUTS GND
 - C 2 INPUTS GND
 - D 1 INPUTS GND
 - E ALL INPUTS V+

"ON" Resistance vs Supply Voltage

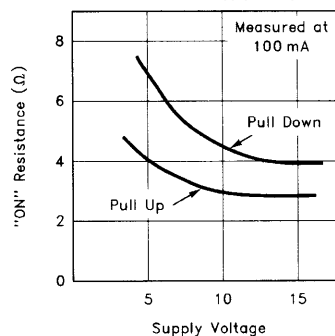

EL7232C

2-Ch, High-Speed, High-Current Line Driver w/3-State

