



MTA 156

TE Internal #: 640643-7

PCB Connector Covers, 7 Position, .156 in [3.96 mm] Centerline, Polyester, Standard Product Profile, Dust Cap, -55 – 105 °C [-67 – 221 °F], MTA 156

[View on TE.com >](#)

Connectors > PCB Connectors > PCB Connector Accessories > PCB Protection & Strain Relief > PCB Connector Covers



Number of Positions: 7

Centerline (Pitch): 3.96 mm [.156 in]

Primary Product Material: Polyester

Product Profile: Standard

Connector Cover Type: Dust Cap

Features

Product Type Features

Product Profile	Standard
Connector Cover Type	Dust Cap

Configuration Features

Number of Positions	7
---------------------	---

Body Features

Primary Product Color	Natural
Primary Product Material	Polyester

Housing Features

Centerline (Pitch)	3.96 mm [.156 in]
--------------------	-------------------

Usage Conditions

Compatible With IDC Installation Type Connector	Feed Thru
Operating Temperature Range	-55 – 105 °C [-67 – 221 °F]

Industry Standards

--	--



UL Flammability Rating	UL 94V-0
------------------------	----------

Product Compliance



[For compliance documentation, visit the product page on TE.com>](#)

EU RoHS Directive 2011/65/EU	Compliant
EU ELV Directive 2000/53/EC	Compliant
China RoHS 2 Directive MIIT Order No 32, 2016	No Restricted Materials Above Threshold
EU REACH Regulation (EC) No. 1907/2006	Current ECHA Candidate List: JUNE 2023 (235) Candidate List Declared Against: JAN 2023 (233) Does not contain REACH SVHC
Halogen Content	Not Low Halogen - contains Br or Cl > 900 ppm.
Solder Process Capability	Not applicable for solder process capability

Product Compliance Disclaimer

This information is provided based on reasonable inquiry of our suppliers and represents our current actual knowledge based on the information they provided. This information is subject to change. The part numbers that TE has identified as EU RoHS compliant have a maximum concentration of 0.1% by weight in homogenous materials for lead, hexavalent chromium, mercury, PBB, PBDE, DBP, BBP, DEHP, DIBP, and 0.01% for cadmium, or qualify for an exemption to these limits as defined in the Annexes of Directive 2011/65/EU (RoHS2). Finished electrical and electronic equipment products will be CE marked as required by Directive 2011/65/EU. Components may not be CE marked. Additionally, the part numbers that TE has identified as EU ELV compliant have a maximum concentration of 0.1% by weight in homogenous materials for lead, hexavalent chromium, and mercury, and 0.01% for cadmium, or qualify for an exemption to these limits as defined in the Annexes of Directive 2000/53/EC (ELV). Regarding the REACH Regulation, the information TE provides on SVHC in articles for this part number is based on the latest European Chemicals Agency (ECHA) 'Guidance on requirements for substances in articles' posted at this URL: <https://echa.europa.eu/guidance-documents/guidance-on-reach>

Compatible Parts

 <p>TE Part # CAT-103156-WBHSM Receptacle Housing: Wire-to-Board, with Mating Alignment, SL156</p>	 <p>TE Part # 640251-7 07P SL156 HSG W/O LCK RAMP</p>	 <p>TE Part # 3-640429-7 07P MTA156 CONN ASSY 24AWG WHT</p>	 <p>TE Part # 640383-7 07P MTA156 HDR ASSY STR SQ SN</p>
---	---	--	---

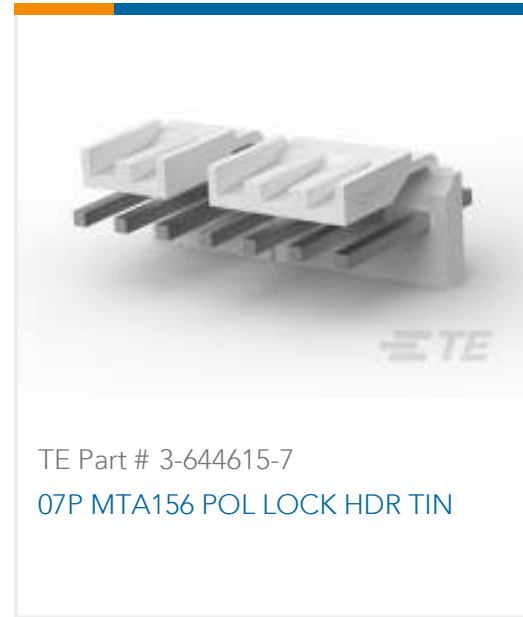

Also in the Series | **MTA 156**

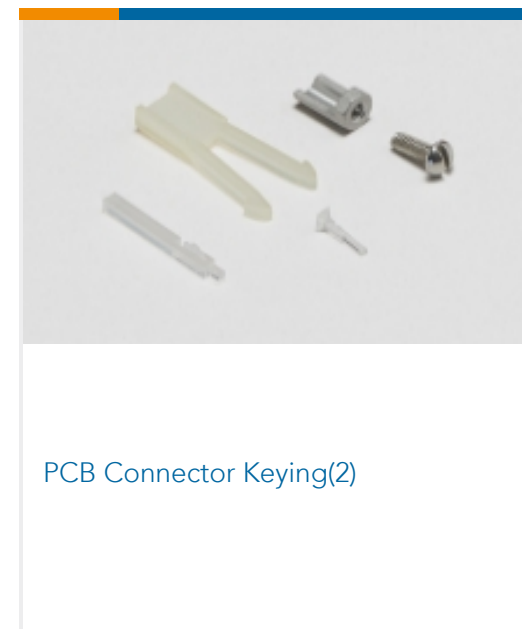
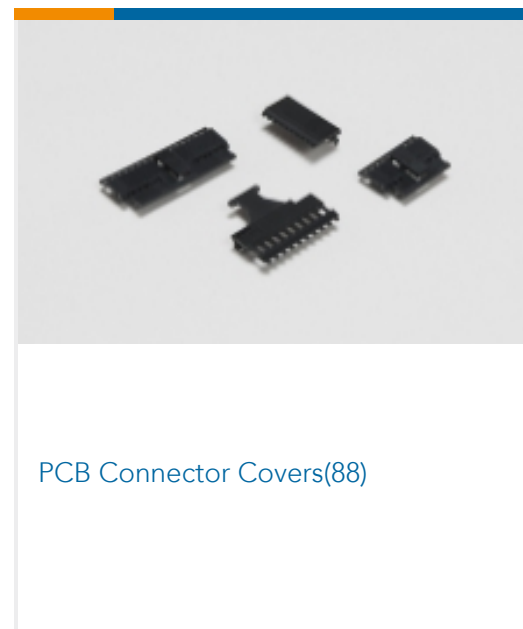
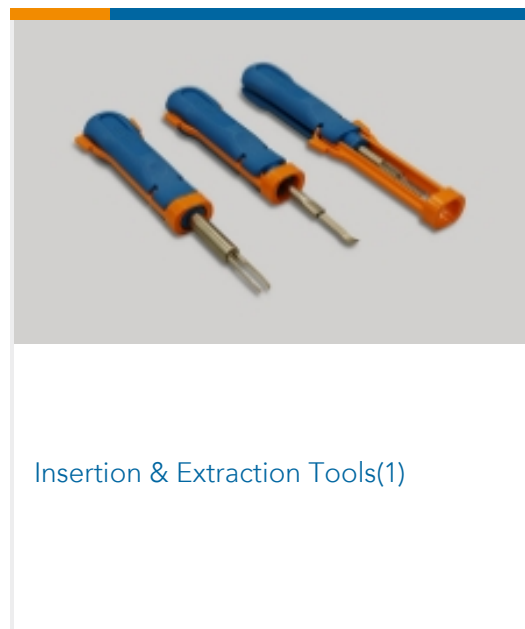

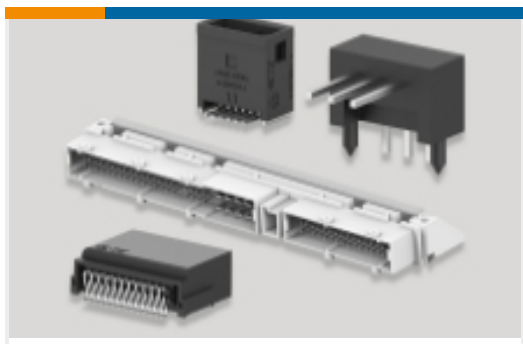

PCB Headers & Receptacles(316)

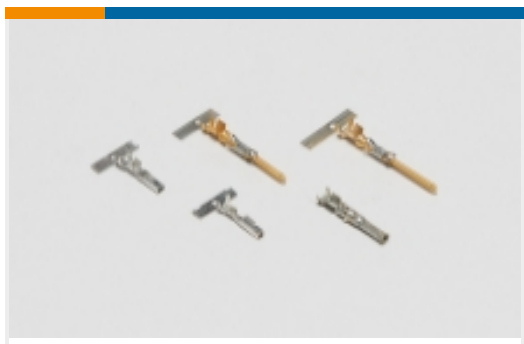

Power Contacts(3)



Rectangular Power Connectors(697)

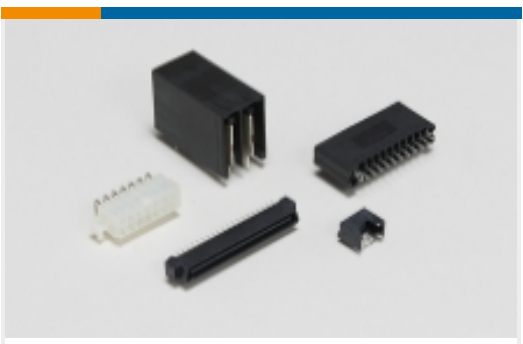

Standard Rectangular Connectors(340)



Wire-to-Board Connector Contacts(3)

Customers Also Bought

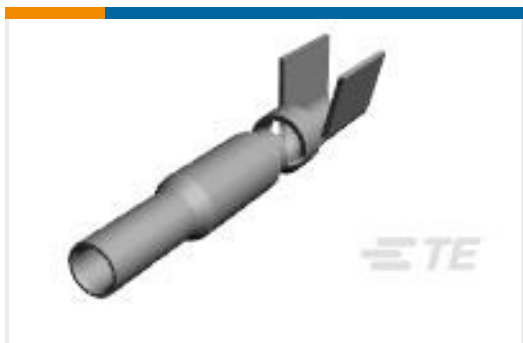

TE Part #770247-3
UMNL II SOK PTPPHBZ LP 12-10



TE Part #770026-1
04P UMNLII IN-LINE CAP HSG KIT

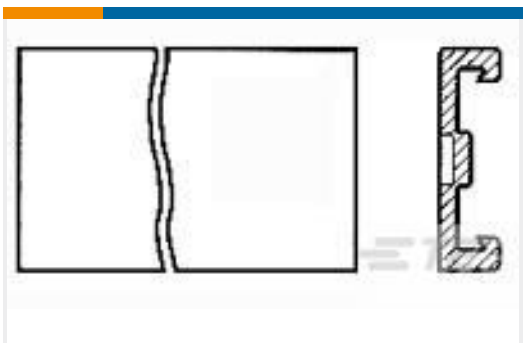

TE Part #640643-5
05P MTA156 COVER F/T



TE Part #640643-6
06P MTA156 COVER F/T

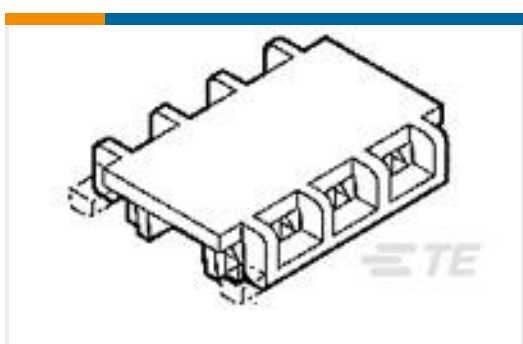

TE Part #643071-2
02P MTA156 FD-THRU COVER



TE Part #3-640600-2
02P MTA156 CONN ASSY 20AWG LF

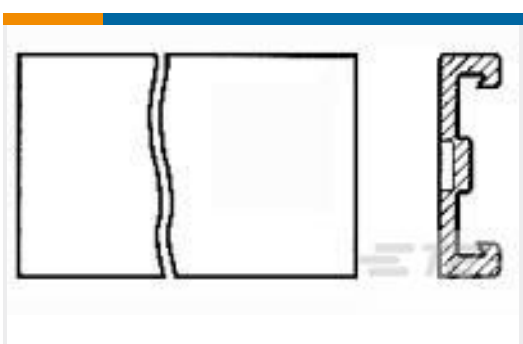

TE Part #640643-8
08P MTA156 COVER F/T

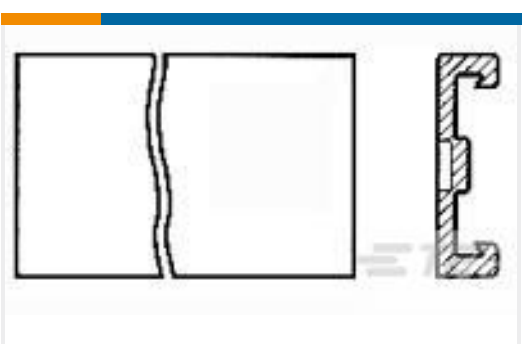

TE Part #640643-3
03P MTA156 COVER F/T



TE Part #770246-3
UMNL II PIN PTPPHBZ LP 12-10



TE Part #3-644466-3
03P MTA156 CONN ASSY 20AWG YEL

Documents



Product Drawings

07P MTA156 COVER F/T

English

CAD Files

3D PDF

3D

Customer View Model

[ENG_CVM_CVM_640643-7_N.2d_dxf.zip](#)

English

Customer View Model

[ENG_CVM_CVM_640643-7_N.3d_igs.zip](#)

English

Customer View Model

[ENG_CVM_CVM_640643-7_N.3d_stp.zip](#)

English

Customer View Model

[ENG_CVM_640643-7_R.3d_igs.zip](#)

English

Customer View Model

[ENG_CVM_640643-7_R.3d_stp.zip](#)

English

Customer View Model

[ENG_CVM_640643-7_R.2d_dxf.zip](#)

English

3D PDF

English

By downloading the CAD file I accept and agree to the [Terms and Conditions](#) of use.

Product Specifications

Application Specification

Japanese

Application Specification

English

MTA 156 Ribbon Cable Connector Assemblies (English And Spanish)

English

MTA 156 Ribbon Cable Connector Assemblies (English And Spanish)

Japanese