

CPDQR5V0HE-HF

RoHS Device
Halogen Free



Features

- Bi-directional ESD protection
- IEC 61000-4-5 (surge) ; IPP=8A
- IEC 61000-4-2 (ESD) ; ±30KV(contact)
- Low clamping voltage
- Low leakage current
- High surge current

Mechanical data

- Case: 0402/SOD-923F Standard package, molded plastic.
- Terminals: Gold plated, solderable per MIL-STD-750, method 2026.
- Mounting position: Any.
- Weight: 0.001 grams(approx.).

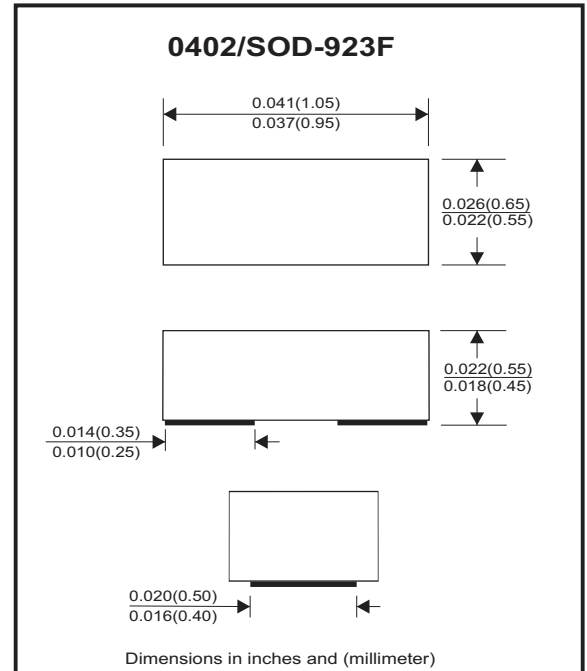

Circuit Diagram



Maximum Rating and Electrical Characteristics (at TA=25°C unless otherwise noted)

Parameter	Conditions	Symbol	Min	Typ	Max	Unit
Reverse stand-Off voltage		VRWM			5	V
Diode breakdown voltage	IR = 1mA	VBD	5.5	7.0		V
Leakage current	VR = 5V	IL		0.1	1.0	uA
Junction capacitance	VR = 0V, f = 1MHz	CT		15	20	pF
ESD capability	IEC 61000-4-2(air)	ESD			30	kV
	IEC 61000-4-2(contact)	ESD			30	kV
Clamping Voltage	IPP = 1 A, tp=8/20us	Vc			11	V
	IPP = 8 A, tp=8/20us	Vc			16	V
Peak pulse power	TP=8/20us	PPP			128	W
Operating temperature range		Tj	-40		+125	°C
Storage temperature range		TSTG	-55		+150	°C

RATING AND CHARACTERISTIC CURVES (CPDQR5V0HE-HF)

Fig.1- 8/20us Peak Pulse Current Wave Form Acc. IEC61000-4-5

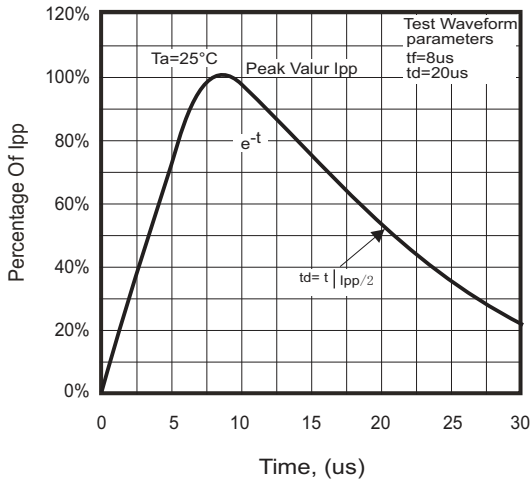

Fig.2 - Typical Capacitance Between Terminals Characteristics

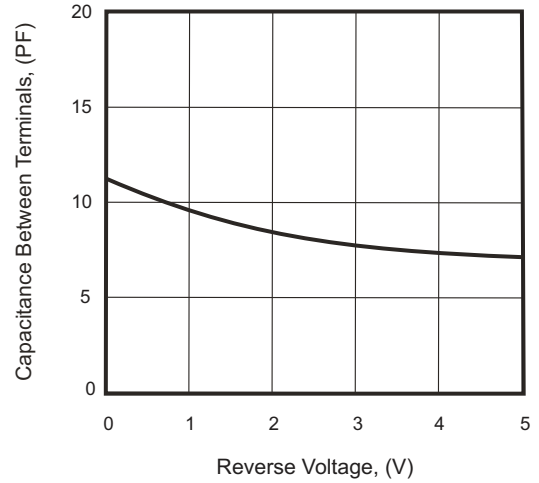

Fig.3 - Clamping Voltage Vs. Peak Pulse Current

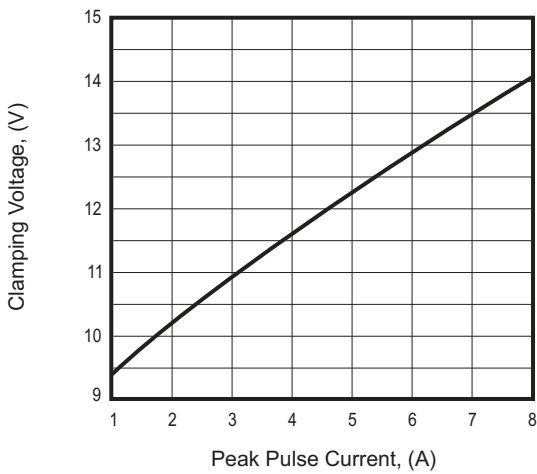
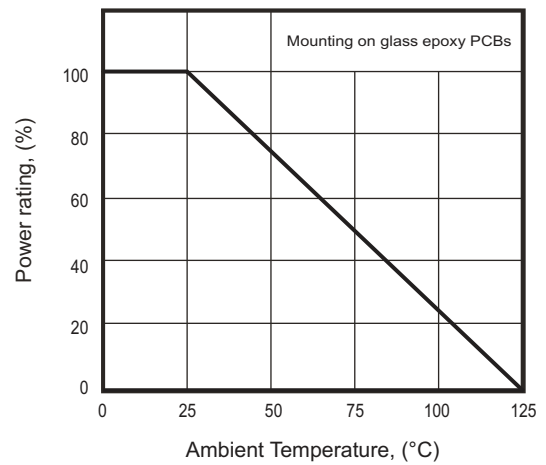
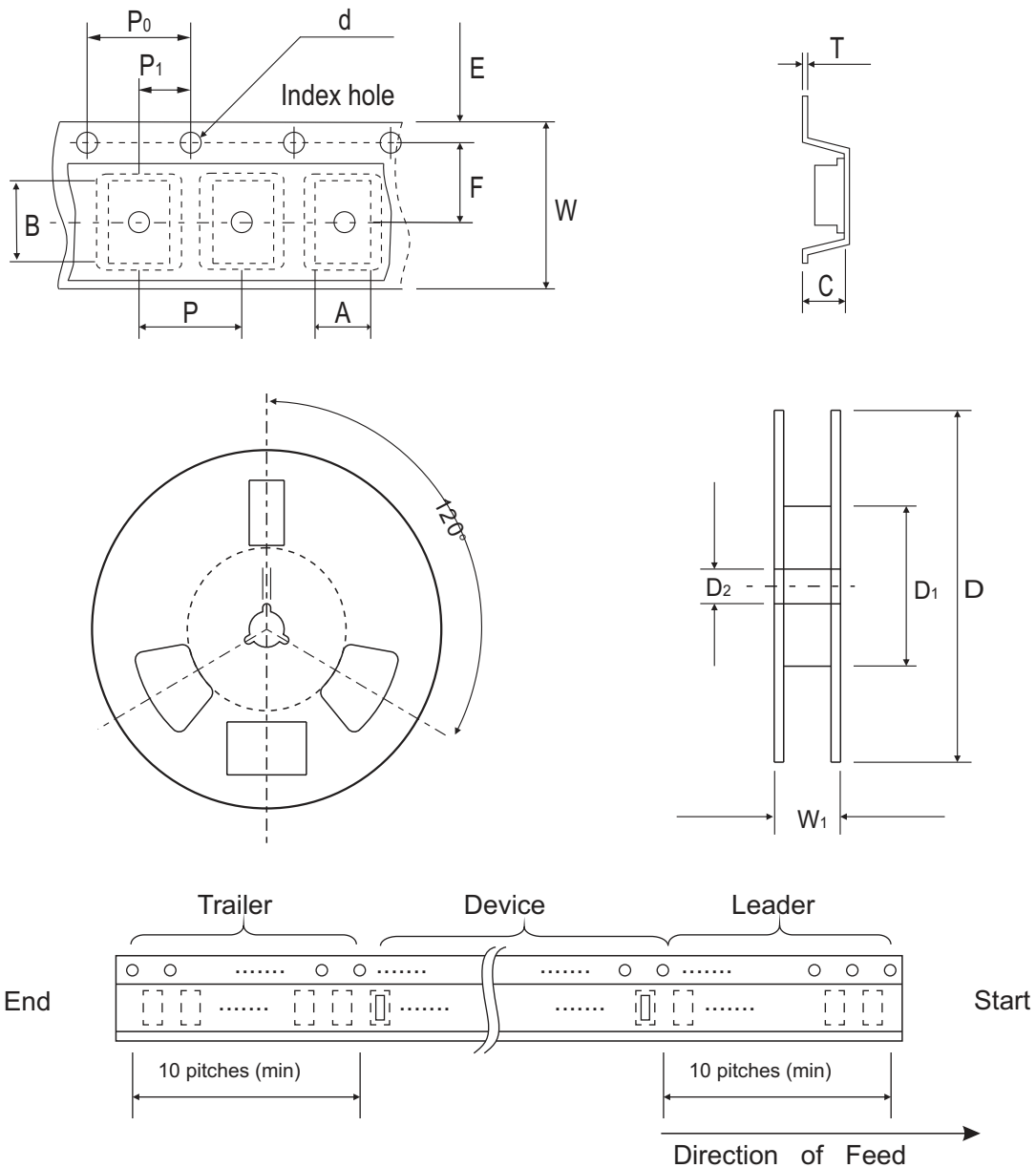

Fig. 4 - Power Rating Derating Curve



Reel Taping Specification



0402/ SOD-923F	SYMBOL	A	B	C	d	D	D ₁	D ₂
	(mm)	0.75 ± 0.10	1.15 ± 0.10	0.60 ± 0.10	1.55 ± 0.10	178 ± 1	60.0 MIN.	13.0 ± 0.20
	(inch)	0.026 ± 0.004	0.045 ± 0.004	0.024 ± 0.004	0.061 ± 0.004	7.008 ± 0.04	2.362 MIN.	0.512 ± 0.008

0402/ SOD-923F	SYMBOL	E	F	P	P ₀	P ₁	T	W	W ₁
	(mm)	1.75 ± 0.10	3.50 ± 0.05	4.00 ± 0.10	4.00 ± 0.10	2.00 ± 0.10	0.22 ± 0.05	8.00 ± 0.20	13.5 MAX.
	(inch)	0.069 ± 0.004	0.138 ± 0.002	0.157 ± 0.004	0.157 ± 0.004	0.079 ± 0.004	0.009 ± 0.002	0.315 ± 0.008	0.531 MAX.

Marking Code

Part Number	Marking Code
CPDQR5V0HE-HF	E5



Suggested PAD Layout

SIZE	0402/SOD-923F	
	(mm)	(inch)
A	0.750	0.030
B	0.500	0.020
C	0.700	0.028
D	1.250	0.049
E	0.250	0.010

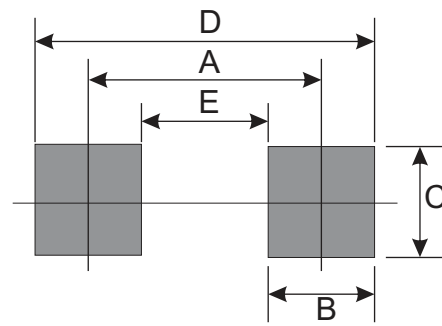

Standard Packaging

Case Type	Qty Per Reel	Reel Size
	(Pcs)	(inch)
0402/SOD-923F	5,000	7