

P-Channel Enhancement Mode Power MOSFET

Description

The RM4953 uses advanced trench technology to provide excellent $R_{DS(ON)}$, low gate charge and operation with gate voltages as low as 4.5V. This device is suitable for use as a load switch or in PWM applications.

General Features

- $V_{DS} = -30V, I_D = -5.1A$
 $R_{DS(ON)} < 90m\Omega @ V_{GS} = -4.5V$
 $R_{DS(ON)} < 55m\Omega @ V_{GS} = -10V$
- High Power and current handling capability
- Lead free product is acquired
- Surface Mount Package

Application

- PWM applications
- Load switch
- Power management
- Halogen-free
- P/N suffix V means AEC-Q101 qualified, e.g:RM4953V

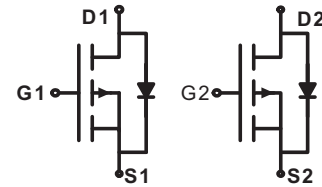

Schematic diagram

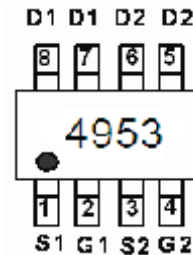

Marking and pin assignment

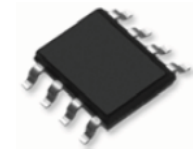

SOP-8 top view

Package Marking and Ordering Information

| Device Marking | Device | Device Package | Reel Size | Tape width | Quantity |
|----------------|--------|----------------|-----------|------------|------------|
| 4953 | RM4953 | SOP-8 | Ø330mm | 12mm | 2500 units |

Absolute Maximum Ratings ($T_A=25^\circ C$ unless otherwise noted)

| Parameter | Symbol | Limit | Unit |
|--|----------------|------------|------------|
| Drain-Source Voltage | V_{DS} | -30 | V |
| Gate-Source Voltage | V_{GS} | ± 20 | V |
| Drain Current-Continuous | I_D | -5.1 | A |
| Drain Current-Pulsed ^(Note 1) | I_{DM} | -20 | A |
| Maximum Power Dissipation | P_D | 2.5 | W |
| Operating Junction and Storage Temperature Range | T_J, T_{STG} | -55 To 150 | $^\circ C$ |

Thermal Characteristic

| | | | |
|---|-----------------|----|--------------|
| Thermal Resistance, Junction-to-Ambient ^(Note 2) | $R_{\theta JA}$ | 50 | $^\circ C/W$ |
|---|-----------------|----|--------------|

Electrical Characteristics ($T_A=25^\circ C$ unless otherwise noted)

| Parameter | Symbol | Condition | Min | Typ | Max | Unit |
|---------------------------------|------------|----------------------------|-----|-----|-----|---------|
| Off Characteristics | | | | | | |
| Drain-Source Breakdown Voltage | BV_{DSS} | $V_{GS}=0V, I_D=-250\mu A$ | -30 | -33 | - | V |
| Zero Gate Voltage Drain Current | I_{DSS} | $V_{DS}=-24V, V_{GS}=0V$ | - | - | -1 | μA |

| | | | | | | |
|--|--------------|---|----|------|-----------|------------|
| Gate-Body Leakage Current | I_{GSS} | $V_{GS}=\pm 20V, V_{DS}=0V$ | - | - | ± 100 | nA |
| On Characteristics ^(Note 3) | | | | | | |
| Gate Threshold Voltage | $V_{GS(th)}$ | $V_{DS}=V_{GS}, I_D=-250\mu A$ | -1 | -1.6 | -3 | V |
| Drain-Source On-State Resistance | $R_{DS(ON)}$ | $V_{GS}=-10V, I_D=-5.1A$ | - | 43 | 55 | m Ω |
| | | $V_{GS}=-4.5V, I_D=-4.2A$ | - | 62 | 90 | m Ω |
| Forward Transconductance | g_{FS} | $V_{DS}=-15V, I_D=-4.5A$ | 4 | 7 | - | S |
| Dynamic Characteristics ^(Note4) | | | | | | |
| Input Capacitance | C_{ISS} | $V_{DS}=-15V, V_{GS}=0V,$ $F=1.0MHz$ | - | 520 | - | PF |
| Output Capacitance | C_{OSS} | | - | 130 | - | PF |
| Reverse Transfer Capacitance | C_{RSS} | | - | 70 | - | PF |
| Switching Characteristics ^(Note 4) | | | | | | |
| Turn-on Delay Time | $t_{d(on)}$ | $V_{DD}=-15V, I_D=-1A,$ $V_{GS}=-10V, R_{GEN}=6\Omega$ | - | 7 | - | nS |
| Turn-on Rise Time | t_r | | - | 13 | - | nS |
| Turn-Off Delay Time | $t_{d(off)}$ | | - | 14 | - | nS |
| Turn-Off Fall Time | t_f | | - | 9 | - | nS |
| Total Gate Charge | Q_g | $V_{DS}=-15V, I_D=-5.1A, V_{GS}=-10V$ | - | 11 | - | nC |
| Gate-Source Charge | Q_{gs} | | - | 2.2 | - | nC |
| Gate-Drain Charge | Q_{gd} | | - | 3 | - | nC |
| Drain-Source Diode Characteristics | | | | | | |
| Diode Forward Voltage ^(Note 3) | V_{SD} | $V_{GS}=0V, I_S=-5.1A$ | - | - | -1.2 | V |

Notes:

1. Repetitive Rating: Pulse width limited by maximum junction temperature.
2. Surface Mounted on FR4 Board, $t \leq 10$ sec.
3. Pulse Test: Pulse Width $\leq 300\mu s$, Duty Cycle $\leq 2\%$.
4. Guaranteed by design, not subject to production

RATING AND CHARACTERISTICS CURVES (RM4953)

Typical Electrical and Thermal Characteristics

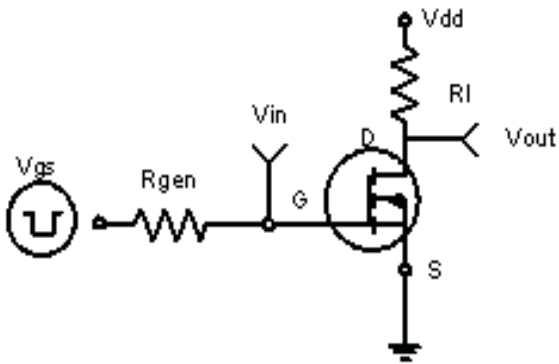

Figure 1: Switching Test Circuit

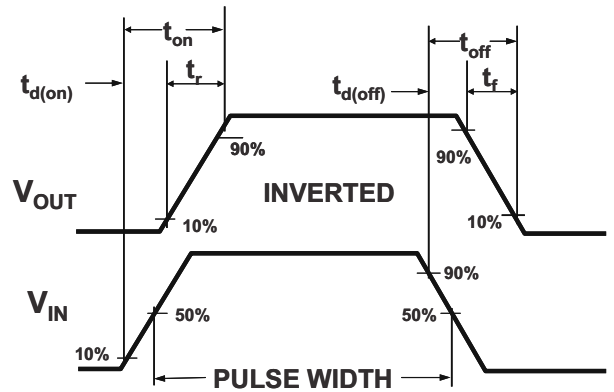

Figure 2: Switching Waveforms

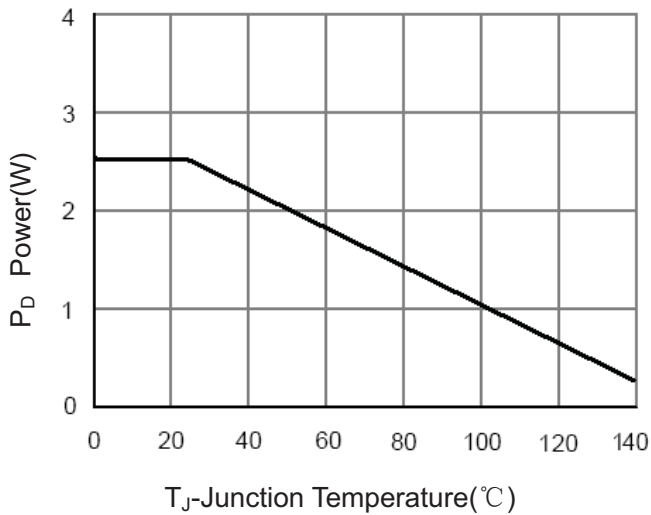

Figure 3 Power Dissipation

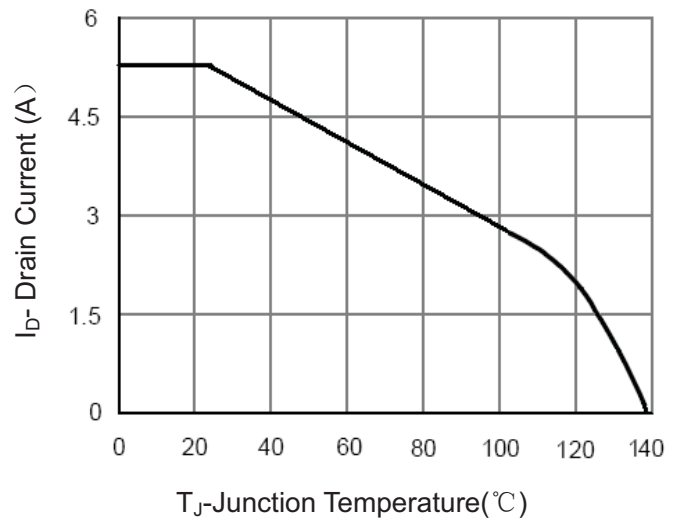

Figure 4 Drain Current

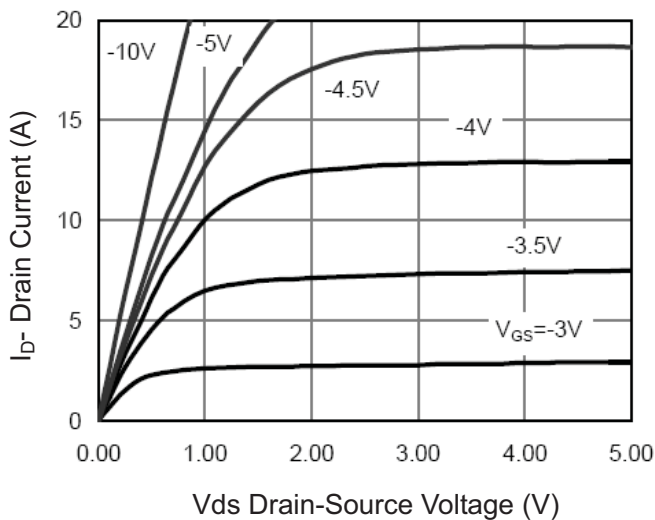

Figure 5 Output Characteristics

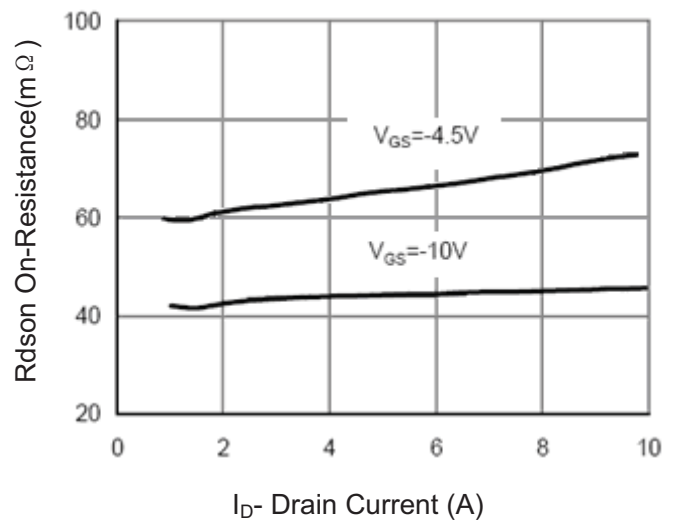
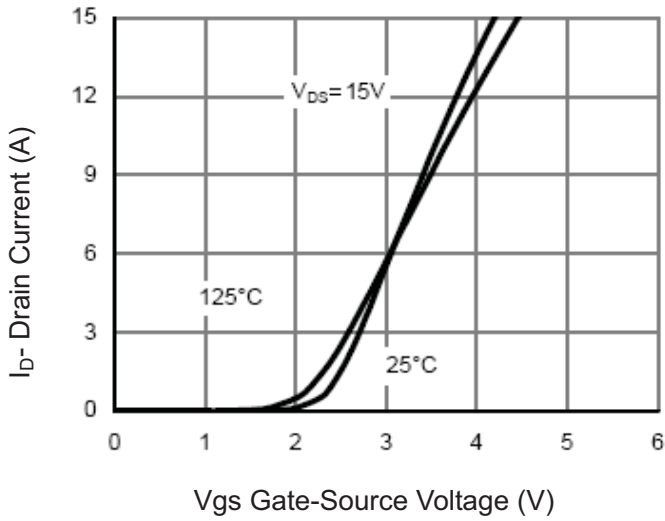
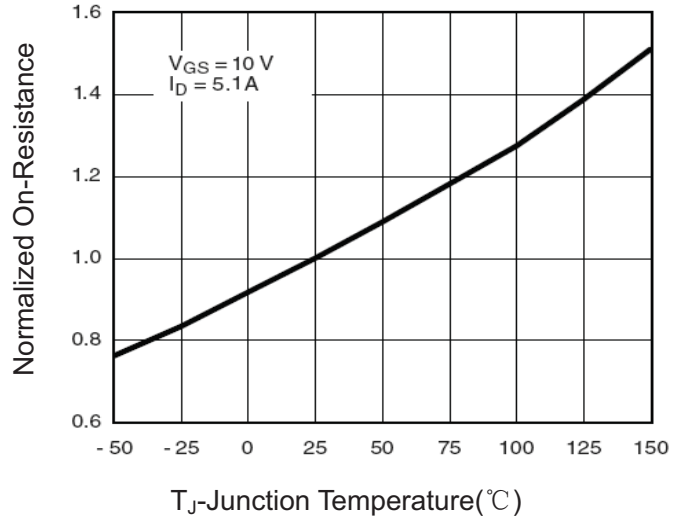

Figure 6 Drain-Source On-Resistance

RATING AND CHARACTERISTICS CURVES (RM4953)



Vgs Gate-Source Voltage (V)
Figure 7 Transfer Characteristics



T_J -Junction Temperature(°C)
Figure 8 Drain-Source On-Resistance

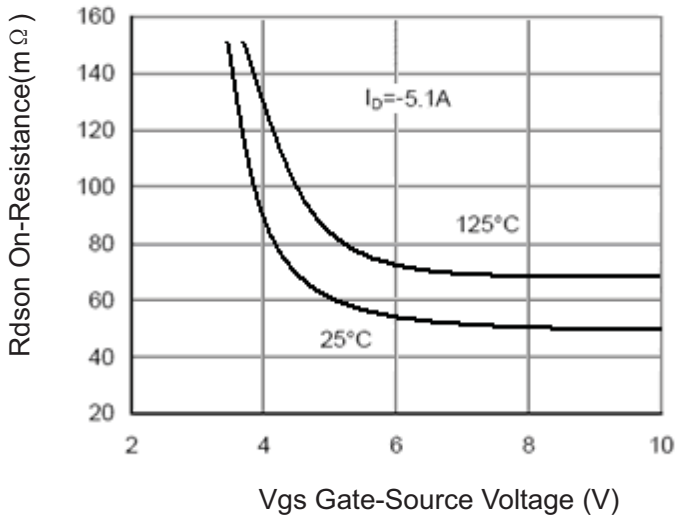

Vgs Gate-Source Voltage (V)
Figure 9 Rdson vs Vgs

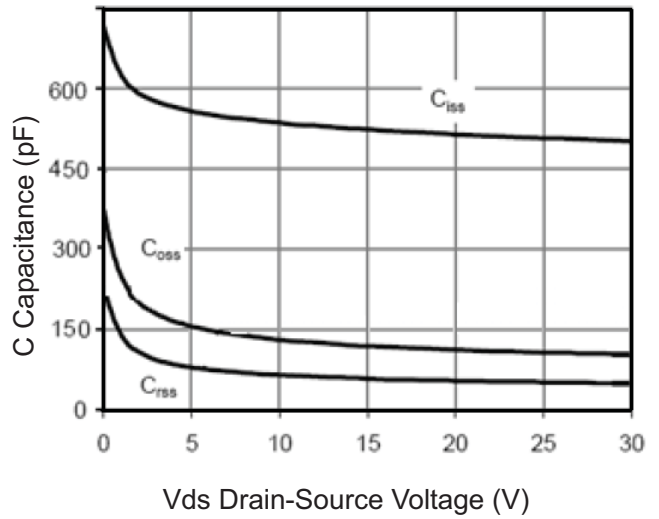

Vds Drain-Source Voltage (V)
Figure 10 Capacitance vs Vds

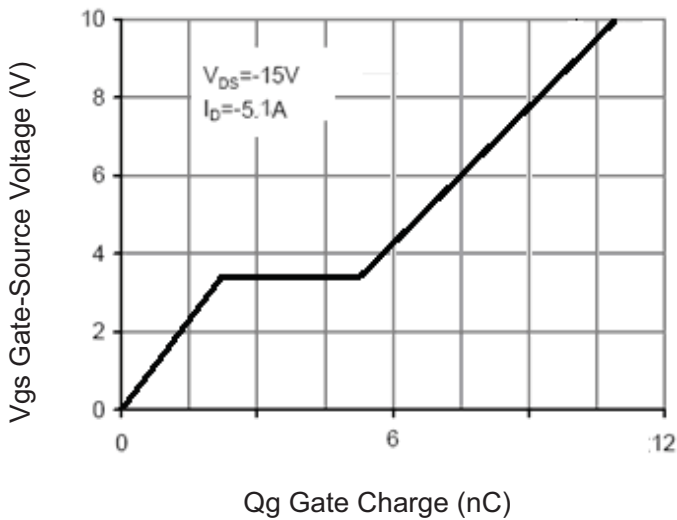

Qg Gate Charge (nC)
Figure 11 Gate Charge

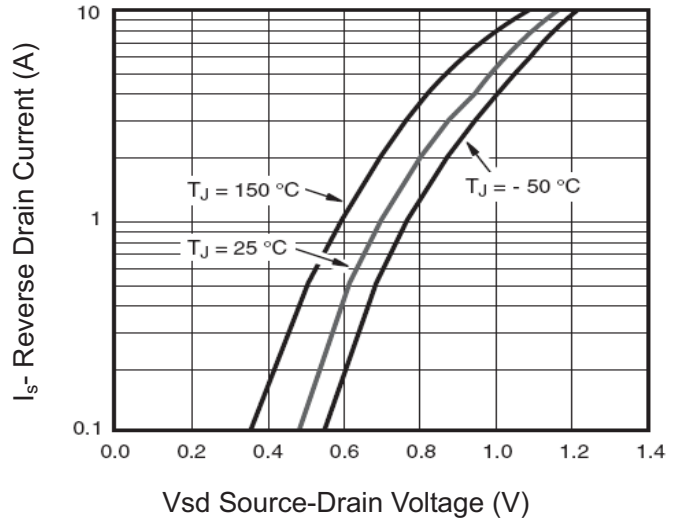

Vsd Source-Drain Voltage (V)
Figure 12 Source- Drain Diode Forward

RATING AND CHARACTERISTICS CURVES (RM4953)

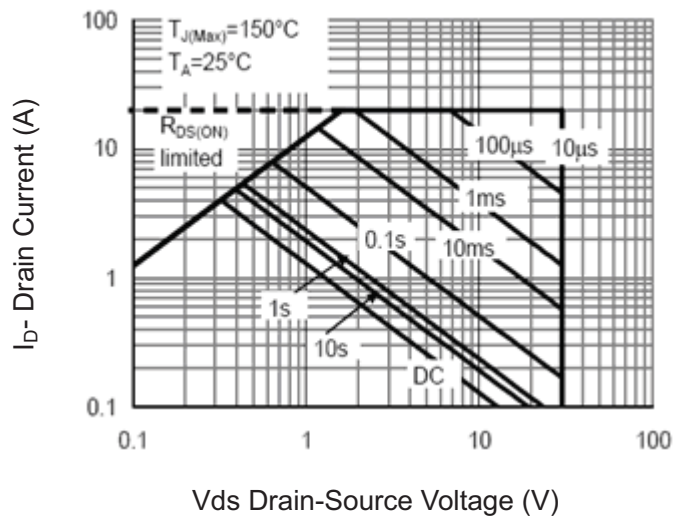

Figure 13 Safe Operation Area

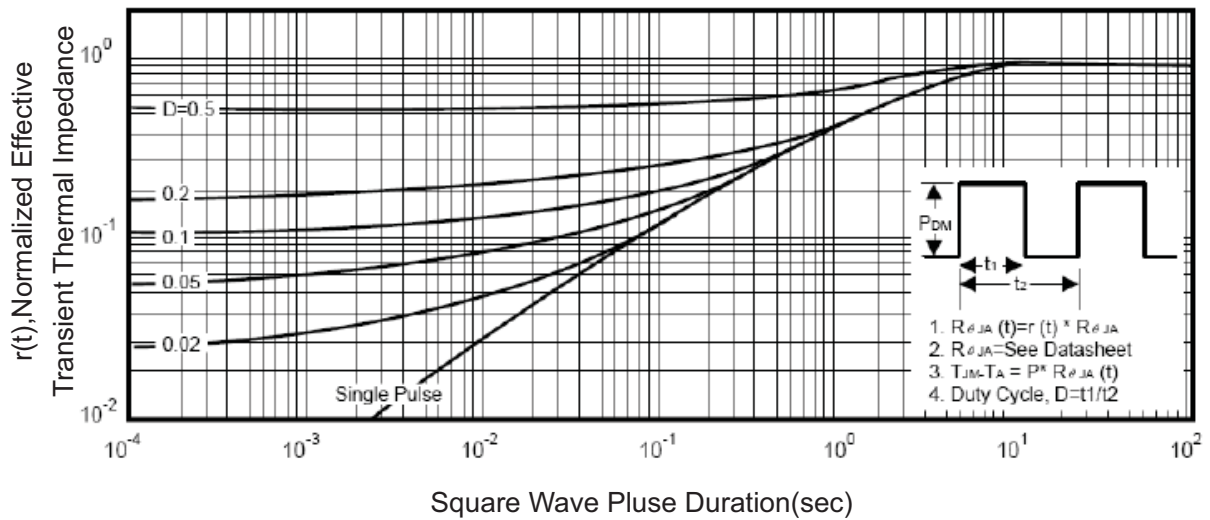
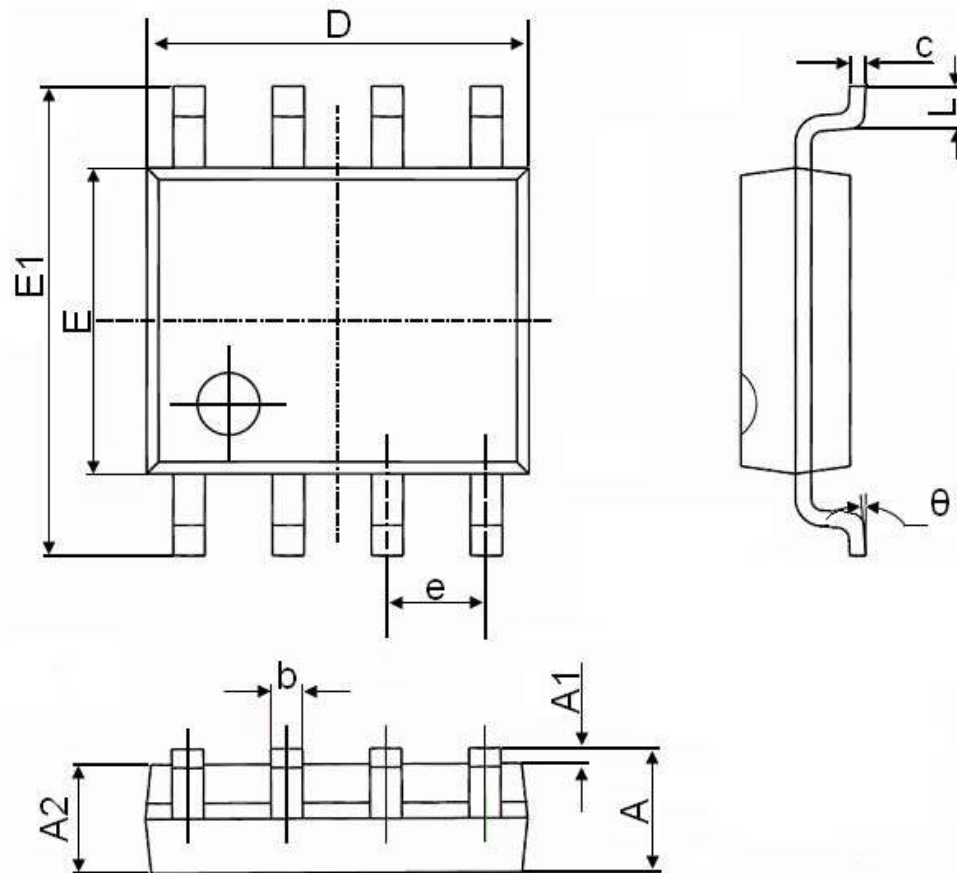

Figure 14 Normalized Maximum Transient Thermal Impedance

SOP-8 Package Information



| Symbol | Dimensions In Millimeters | | Dimensions In Inches | |
|----------|---------------------------|-------|----------------------|-------|
| | Min. | Max. | Min. | Max. |
| A | 1.350 | 1.750 | 0.053 | 0.069 |
| A1 | 0.100 | 0.250 | 0.004 | 0.010 |
| A2 | 1.350 | 1.550 | 0.053 | 0.061 |
| b | 0.330 | 0.510 | 0.013 | 0.020 |
| c | 0.170 | 0.250 | 0.006 | 0.010 |
| D | 4.700 | 5.100 | 0.185 | 0.200 |
| E | 3.800 | 4.000 | 0.150 | 0.157 |
| E1 | 5.800 | 6.200 | 0.228 | 0.244 |
| e | 1.270(BSC) | | 0.050(BSC) | |
| L | 0.400 | 1.270 | 0.016 | 0.050 |
| θ | 0° | 8° | 0° | 8° |

DISCLAIMER NOTICE

Rectron Inc reserves the right to make changes without notice to any product specification herein, to make corrections, modifications, enhancements or other changes. Rectron Inc or anyone on its behalf assumes no responsibility or liability for any errors or inaccuracies. Data sheet specifications and its information contained are intended to provide a product description only. "Typical" parameters which may be included on RECTRON data sheets and/ or specifications can and do vary in different applications and actual performance may vary over time. Rectron Inc does not assume any liability arising out of the application or use of any product or circuit.

Rectron products are not designed, intended or authorized for use in medical, life-saving implant or other applications intended for life-sustaining or other related applications where a failure or malfunction of component or circuitry may directly or indirectly cause injury or threaten a life without expressed written approval of Rectron Inc. Customers using or selling Rectron components for use in such applications do so at their own risk and shall agree to fully indemnify Rectron Inc and its subsidiaries harmless against all claims, damages and expenditures.