

1.5A Single Flash LED Driver IC in a TDFN Package

General Description

The SKY81279 is a high-efficiency, 1.5A high-current boost converter with a programmable constant current sink. It is an ideal power solution for LED photo flash applications in all single-cell Li-ion powered products.

The SKY81279 maintains output current regulation by switching the internal high-side and low-side switch transistors. The transistor switches are pulse-width modulated at a fixed frequency of 2.0MHz. The high switching frequency allows the use of a small external inductor and output capacitor.

Skyworks' proprietary AS²Cwire™ (Advanced Simple Serial Control) serial digital interface is used to enable, disable, configure, and program the operation of the SKY81279. Using the AS²Cwire interface, the LED flash and movie-mode currents can be programmed to different levels. The SKY81279 includes a separate Flash Enable input to initiate the flash operation and a Flash Inhibit pin to quickly reduce the flash current to movie-mode levels during high battery demand.

The SKY81279 contains a thermal management system to protect the device in the event of output short circuit. Built-in circuitry prevents excessive inrush current during start-up. The shutdown feature reduces quiescent current to less than 1.0µA.

The SKY81279 is available in a a Pb-free, 14-pin 2mm x 3mm TDFN package.

Features

- Input Voltage Range: 2.7V to 5.5V
- Single Channel Flash Output
- Up to 1.5A Regulated Output Current
- Up to 88% Efficiency
- 2.0 MHz Switching Frequency
- Separate Flash Enable
- Single Resistor Sets Flash and Movie Mode Current
- AS²Cwire Single Wire Programming:
 - Flash Current Ratio
 - Movie Mode Current
 - Output Enable Control
- True Load Disconnect
- Soft-Start and Input Current Limit
- Over-Voltage, Open and Shorted LED, Short-Circuit, and Over-Temperature Protection
- -40°C to +85°C Temperature Range
- 14-pin 2mm x 3mm TDFN package

Applications

- LED Photo Flash/Torch
- Camera Enabled Mobile Devices
- Cellphones/Smartphones
- Digital Still Cameras (DSCs)
- Multimedia Mobile Phones

Typical Application

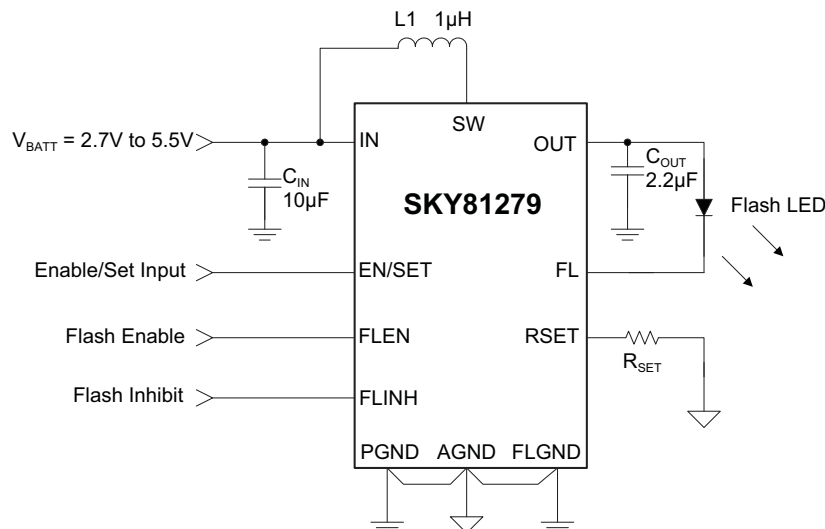

1.5A Single Flash LED Driver IC in a TDFN Package**Pin Descriptions**

Pin #	Symbol	Description
2	EN/SET	Enable and Serial Control input. EN/SET is the AS ² Cwire addressing and programming input to adjust the Movie-mode and Flash-mode current levels.
4	FLEN	Flash Enable pin. A low-to-high transition on the FLEN pin initiates a flash pulse, and a high-to-low transition on the FLEN pin terminates a flash pulse.
1,5	AGND	Analog Ground pin. Connect AGND to PGND and FLGND at a single point as close to the IC as possible.
7	PGND	Power Ground. Connect PGND to the same single point as AGND located as close to the IC as possible.
14	RSET	Flash Current Set pin. Connect a resistor from RSET to AGND to program the desired flash current for the current sink FL.
6	IN	Flash Output Boost Converter Power input. Connect IN to the input power source. Connect a 10 μ F or larger ceramic capacitor from IN to PGND and locate as close as possible to the IC package for optimum performance.
10	SW	Boost Converter Switching node. Connect a 1 μ H inductor between SW and IN.
3	FL	LED Flash Current Sink pin. Connect the cathode of Flash LED to FL.
13	FLGND	Flash Ground pin. Connect FLGND to PGND and AGND at a single point as close to the IC as possible.
11	FLINH	Flash Inhibit pin. FLINH is an active HIGH control input with an internal 200k Ω resistor to AGND. A low-to-high transition on the FLINH pin reduces FL sink current to the maximum (default) Movie-mode current level.
8	OUT	Power output of the boost converter. Connect a 2.2 μ F or larger ceramic capacitor from OUT to PGND as close as possible to the IC. Connect OUT to the anode of the Flash LED.
9, 12	NC	No connect
EP	EP	Exposed paddle (bottom). Connect EP to PGND as close as possible to the IC.

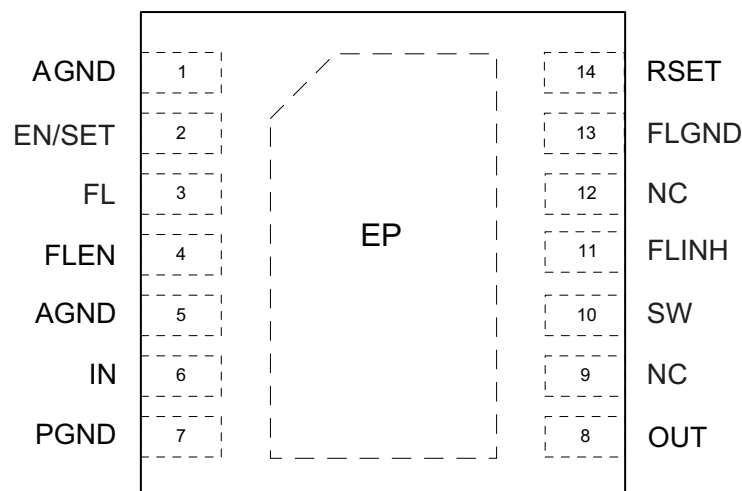
Pin Configuration**TDFN 2mm \times 3mm
(Top View)**

1.5A Single Flash LED Driver IC in a TDFN Package**Absolute Maximum Ratings¹**

Symbol	Description	Value	Units
IN, OUT, SW	Maximum Rating	-0.3 to 6.0	V
EN/SET, FLEN, FLINH, RSET, FL	Maximum Rating	-0.3 to $V_{IN} + 0.3$	
T_J	Operating Junction Temperature Range	-40 to 150	°C
T_S	Storage Temperature Range	-65 to 150	
T_{LEAD}	Maximum Soldering Temperature (at Leads, 10 sec)	300	

Thermal Information²

Symbol	Description	Value	Units
θ_{JA}	Thermal Resistance ³	54	°C/W
P_D	Maximum Power Dissipation ⁴	2.1	W

1. Stresses above those listed in Absolute Maximum Ratings may cause permanent damage to the device. Functional operation at conditions other than the operating conditions specified is not implied.

2. Based on long-term current density limitation.

3. Mounted on an FR4 board.

4. Derate 18.5 mW/°C above 25°C

1.5A Single Flash LED Driver IC in a TDFN Package

Electrical Characteristics

$V_{IN} = 3.6V$; $C_{IN} = 10\mu F$; $C_{OUT} = 2.2\mu F$; $R_{SET} = 162k\Omega$; $L = 1\mu H$; $T_A = -40^\circ C$ to $85^\circ C$ unless otherwise noted. Typical values are at $T_A = 25^\circ C$.

Symbol	Description	Conditions	Min	Typ	Max	Units
Power Supply – Switching Flash Driver						
V_{IN}	Input Voltage Range		2.7		5.5	V
V_{UVLO}	Input under Voltage Lockout	V_{IN} rising		2.4		
$V_{OUT(MAX)}$	Maximum Output Voltage				5.5	
$I_{IN(Q)}$	Supply Current	EN/SET = FLEN = IN, Set FL Load = 1.0A		1.4		mA
		EN/SET = IN, FLEN = AGND		0.7		
$I_{SHDN(MAX)}$	Input Shutdown Current	EN/SET, FLEN = AGND			1.0	μA
$I_{FL(ACC)}$	Flash Current Accuracy	$I_{FL} = 1.0A$	-8		+8	%
I_{LIM}	Boost current Limit	SKY81279-11	2.52	3.15	3.78	A
$I_{MM(LOAD)}$	Total Output Current, Movie Mode	Movie mode current set to 100%, $I_{FL} = 1.0A$		143		mA
$I_{MM(ACC)}$	Movie Mode Current Accuracy	$I_{MM} = 143mA$	-10		+10	%
$I_{FL/I_{MM}}$	Flash to Movie Mode Ratio			7		
F_{OSC}	Switching Frequency	$T_A = 25^\circ C$	1.5	2.0	2.5	MHz
T_{SD}	Over-Temperature Shutdown Threshold			140		$^\circ C$
$T_{SD(HYS)}$	Over-Temperature Shutdown Hysteresis			15		
EN/SET, FLEN						
$V_{EN/SET(H)}$, $V_{FLEN(H)}$, $V_{FLINH(H)}$	EN/SET, FLEN, FLINH Input High Threshold		1.4			V
$V_{EN/SET(L)}$, $V_{FLEN(L)}$, $V_{FLINH(L)}$	EN/SET, FLEN, FLINH Input Low Threshold				0.4	
$I_{EN/SET}$, I_{FLEN}	EN/SET, FLEN Input Leakage Current	$V_{EN/SET}$, $V_{FLEN} = IN = 5V$	-1		1	μA
$R_{IN(FLINH)}$	FLINH Input Resistance to AGND			200		k Ω
$t_{EN/SET(LO)}$	EN/SET Serial Interface Low Time		0.3		12	μs
$t_{EN/SET(HI-MIN)}$	Minimum EN/SET High Time			50		ns
$t_{EN/SET(HI-MAX)}$	Maximum EN/SET High Time				12	μs
$t_{EN/SET(OFF)}$	EN/SET Off Timeout time				500	
$t_{EN/SET(LAT)}$	EN/SET Latch Timeout Time				500	
$t_{FLEN(ON)}$	FLEN On Delay Time	EN/SET = AGND		40		
$t_{FLEN(OFF)}$	FLEN Off Delay Time	EN/SET = AGND		10		
t_{FLINH_ON}	FLINH ON Delay Time			93		
Auto Disable Function¹						
$V_{LED(DETECT)}$	Shorted LED Detection Voltage	$V_{IN} = 3V$, $I_{LED} = 2.4mA$	1.7			V

1. Guaranteed by design.

1.5A Single Flash LED Driver IC in a TDFN Package

Typical Characteristics

Flash Mode Efficiency vs. Input Voltage

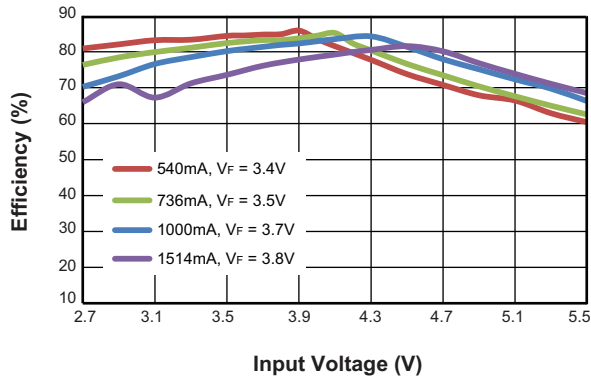

Movie Mode Efficiency vs. Input Voltage

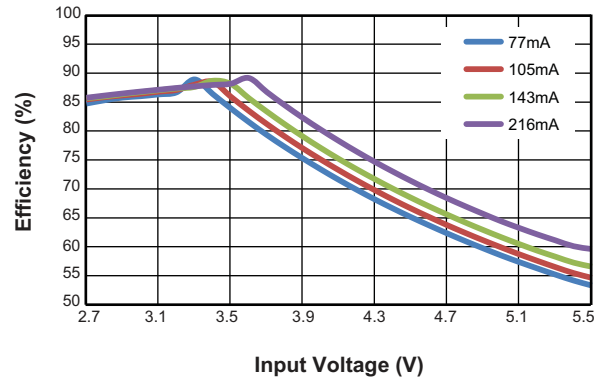

Flash Mode Accuracy vs. Temperature
(I_{FL} = 1.5A, V_{IN} = 3.6V, L = 1μH)

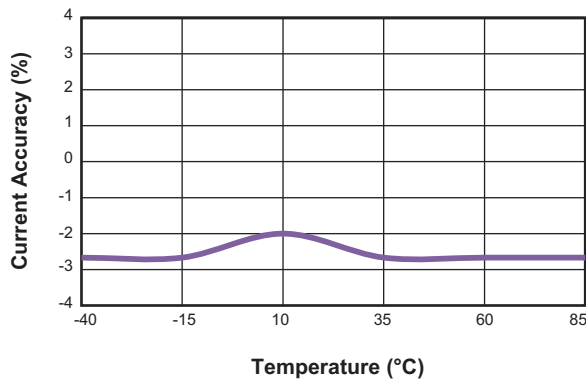

Movie Mode Accuracy vs. Temperature
(I_{FL} = 216mA, V_{IN} = 3.6V, L = 1μH)

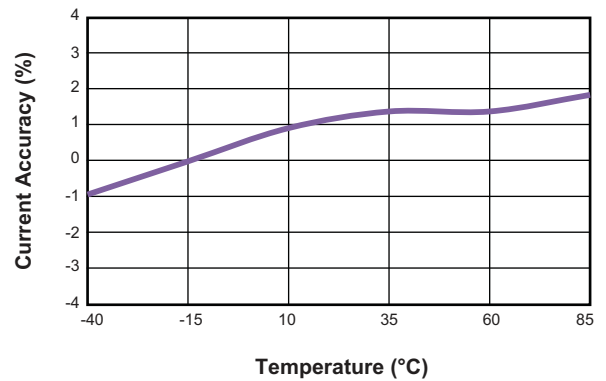

EN/SET Latch Timeout vs. Input Voltage

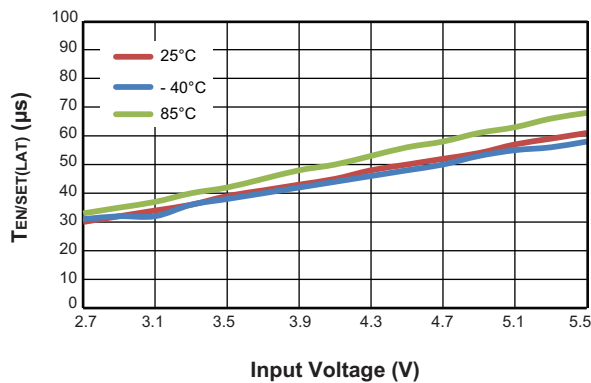

Flash On-Time Delay vs. Input Voltage
(I_{FL} = 1.5A, C_{OUT} = 2.2μH, L = 1μH)

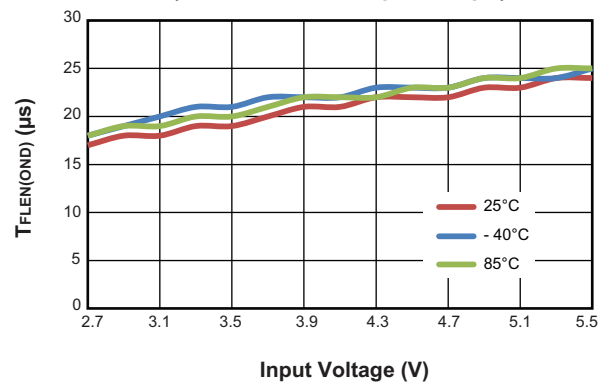

Typical Characteristics

EN/SET Off Timeout vs. Input Voltage

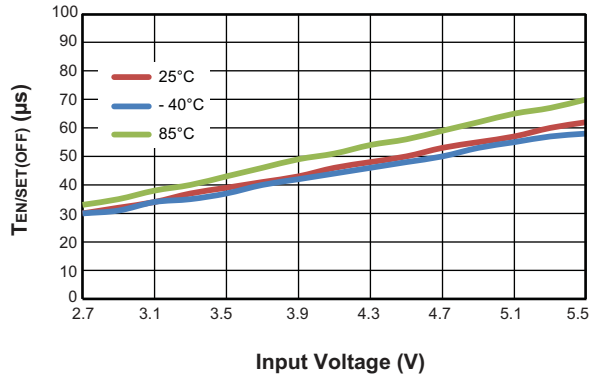

EN/SET, FLEN High Threshold Voltage vs. Input Voltage

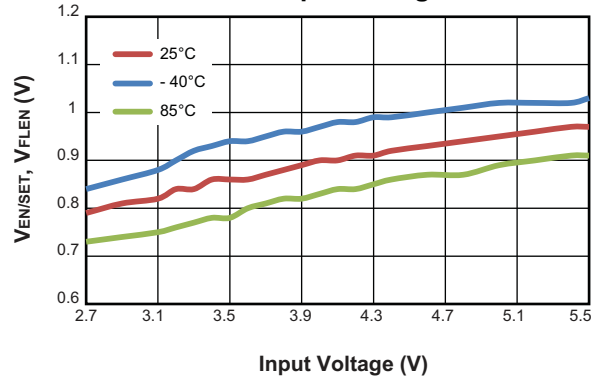

EN/SET, FLEN Low Threshold Voltage vs. Input Voltage

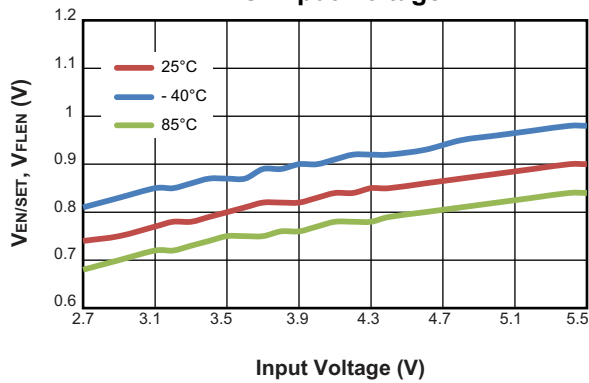

Boost Switching Frequency vs. Input Voltage (T_A = 25°C, L = 1µH)

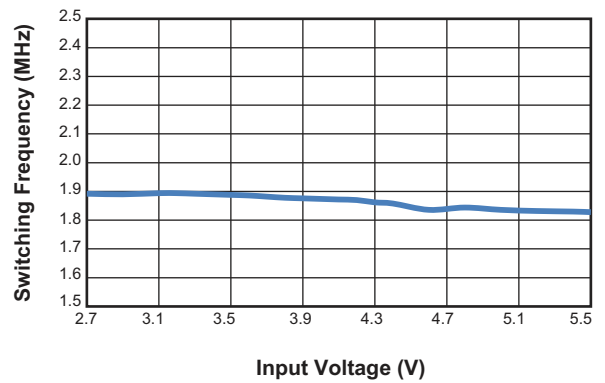

Supply Current vs. Input Voltage (V_{FEN/SET} = V_{FLEN} = V_{IN}, I_{FL} = 0mA, Non-Switching)

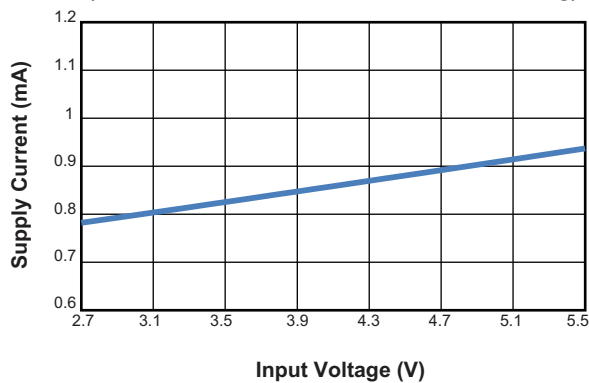

1.5A Single Flash LED Driver IC in a TDFN Package

Typical Characteristics

Movie Mode Transistion Characteristic

($I_{FL} = 11\text{mA to } 216\text{mA}$, $C_{OUT} = 2.2\mu\text{F}$, $V_{IN} = 3.6\text{V}$, $L = 1\mu\text{H}$)

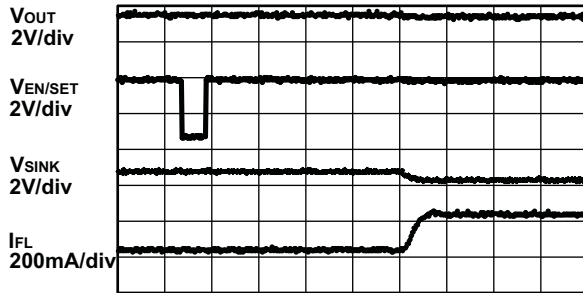

Time (20 $\mu\text{s/div}$)

Flash Mode Ripple

($I_{FL} = 1.5\text{A}$, $C_{OUT} = 2.2\mu\text{F}$, $V_{IN} = 3.6\text{V}$, $L = 1\mu\text{H}$)

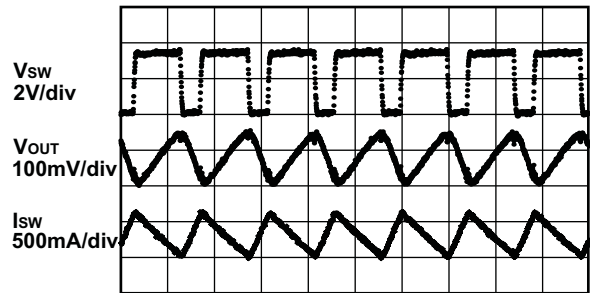

Time (400ns/div)

Movie Mode Ripple

($I_{MM} = 214\text{mA}$, $C_{OUT} = 2.2\mu\text{F}$, $V_{IN} = 3.3\text{V}$, $L = 1\mu\text{H}$)

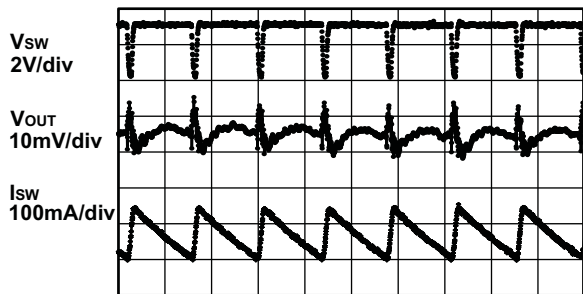

Time (400ns/div)

Flash Turn On Characteristic

($I_{FL} = 1.5\text{A}$, $C_{OUT} = 2.2\mu\text{F}$, $V_{IN} = 3.6\text{V}$, $L = 1\mu\text{H}$)

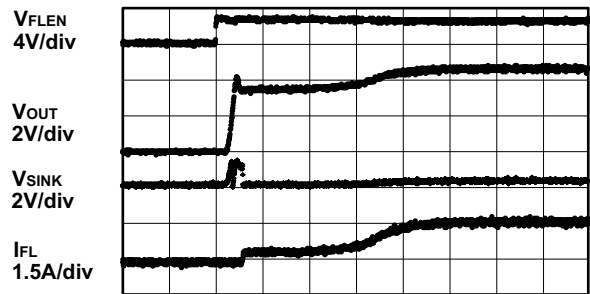

Time (40 $\mu\text{s/div}$)

Movie Turn On Characteristic

($I_{MM} = 171\text{mA}$, $C_{OUT} = 2.2\mu\text{F}$, $V_{IN} = 3.6\text{V}$, $L = 1\mu\text{H}$)

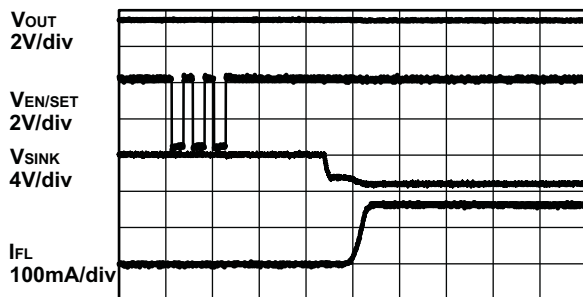

Time (20 $\mu\text{s/div}$)

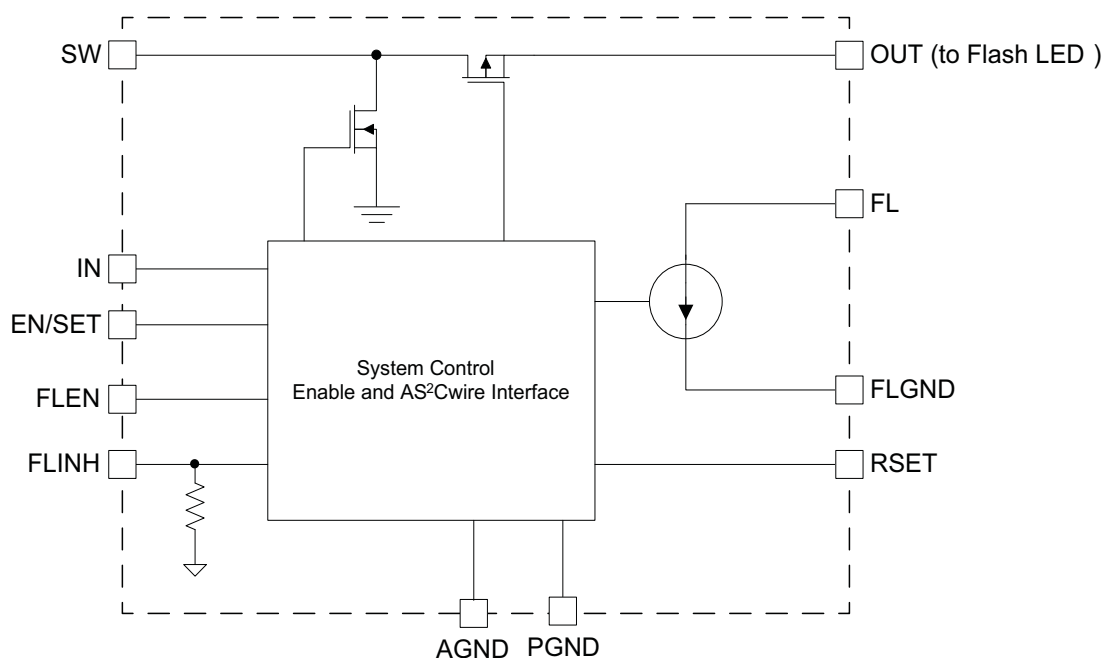
*1.5A Single Flash LED Driver IC in a TDFN Package***Functional Block Diagram****Functional Description**

The SKY81279 is a boost converter with a current regulated output to drive high current white LED used in camera flash applications. The SKY81279 has a constant current sink channel to accurately regulate the current flow through a high current, high intensity white Flash LED. The SKY81279 has two basic operating modes; a Flash mode controlled by the FLEN pin and the Movie/Torch light mode controlled through the AS²Cwire interface.

Flash Mode

A flash pulse is initiated by strobing the FLEN input pin low-to-high. The maximum flash current in the SKY81279 is set by an external resistor, R_{SET} , which sets the flash current and the maximum Movie-Mode current. In mobile GSM systems where the phone remains in constant contact with the base station by regular communication, a FLINH pin is provided to prevent both the camera flash and PA transmission pulses from occurring simultaneously. This avoids potential dips to the Li-ion battery voltage below the system's shutdown. During a flash event, strobing the FLINH pin low-to-high reduces the LED current to the default Movie-Mode current level

for the duration of FLINH. Strobing FLINH high-to-low instructs the SKY81279 to revert the flash LED current to its maximum level, assuming that the FLEN pin is still active (HIGH).

Movie (Torch) Mode

The Movie/Torch mode current level is programmed by the SKY81279 AS²Cwire interface. The Movie-mode current level can be adjusted to one of 16 values using a logarithmic scale, where each code level is 1dB below the previous code. The maximum Movie mode current is fixed at 1/7 fraction of the maximum programmed flash current set by the R_{SET} resistor. The manual FLEN signal has priority over Movie-mode operation.

Movie mode operation is controlled entirely by the AS²Cwire interface via the EN/SET pin. The FLEN signal will override Movie-mode SKY81279 operation when toggled to a logic high level. The part will not reenter Movie mode when FLEN is brought low. To reenter Movie mode after a flash event, the part must be cycled off and back on to reset the Movie mode and reprogrammed via the AS²Cwire interface to the desired Movie mode operation.

1.5A Single Flash LED Driver IC in a TDFN Package**Over-Voltage Protection**

The SKY81279 boost converter output voltage is limited by internal overvoltage protection circuitry to prevent damage to the device. During an over-voltage protection condition, the output voltage will rise to 5.5V (max). The OVP circuit disables the boost converter to prevent the output voltage from rising above 5.5V. Once the OVP condition is removed, normal boost operation will resume.

Open Flash LED Protection

The SKY81279 has an open flash LED protection. The output voltage will climb to the OVP voltage in the event of open flash LED, and both the boost converter and the current sink will immediately be shut down and latched off. Once removing the open flash LED condition and re-enabling or re-powering, the SKY81279 can resume normal work.

Short Circuit Protection

The short circuit protection of SKY81279 includes protections for three kinds of short faults: flash LED short, VOUT to GND short and FL to GND short.

When the fault of flash LED short occurs, the SKY81279 is equipped with an auto-disable feature for the flash LED channel. After the IC is enabled and system commences start-up, a test current of 2-3mA (typical) is forced through the sink channel. The channel will be disabled if the voltage of the SINK pin does not drop to the predetermined threshold. This feature is very convenient for disabling the current sink in the event of flash LED short-circuit fault. This small test current is added to the set output current in both Flash and Movie mode conditions.

When the event of short VOUT to GND happens, a limited current of about 3A will flow from VIN to GND and last for several microseconds, then both the boost converter and current sink will be latched off. The SKY81279 can work again once removing the short VOUT to GND condition and re-enabling or re-powering.

When the event of short FL to GND happens and lasts for several microseconds, with FL voltage lower than a certain level, the boost converter and the current sink will all be latched off. The SKY81279 can resume work once removing the short FL to GND condition and re-enabling or re-powering.

Over-Temperature Protection

The SKY81279 has internal thermal protection circuitry to disable the device when the internal power dissipation exceeds the preset thermal limit. The junction over-temperature threshold is typically 140°C. During Flash or Movie-mode operation, should an environmental condition, flash current sink or the boost converter cause the internal die temperature to rise above 140°C, the boost converter will be shut down and latched off. The SKY81279 will resume normal operation once removing the over-temperature fault and re-enabling or re-powering.

Application Information**Flash Mode LED Current**

Flash sink current can be programmed up to a maximum of 1.5A. The maximum flash current is set by the R_{SET} resistor. For the desired flash current, the resistor value can be calculated using the following equation:

$$I_{FL} = \frac{162k\Omega \cdot A}{R_{SET}}$$

A flash event is initiated by asserting the FLEN pin. A flash event is automatically terminated when FLEN is de-asserted. Any time that the FLINH pin is asserted, the default Movie-mode current level will appear at FL channel. The default Movie mode current level will be maintained on FL as long as the FLINH and FLEN pins are asserted. In addition to setting the flash current via R_{SET} , the flash current can be changed after FLEN is asserted by programming the Movie mode current register with 16 different steps.

AS²Cwire Control of Movie Mode Operation

In the SKY81279, the control of the Movie mode operation is managed by the AS²Cwire interface. AS²Cwire relies on the number of rising edges of the EN/SET pin to address and load internal data registers. Referring to Table 1:

- Address 0 controls the Movie mode (MM) current level as a percentage of the maximum Movie mode current level.
- The last column in Table 1 shows the default values for each of the address registers.

1.5A Single Flash LED Driver IC in a TDFN Package

AS²Cwire Serial Interface

AS²Cwire latches data or address after the EN/SET pin has been held high for longer than t_{LAT} (500 μ s). Address or data are differentiated by the number of EN/SET rising edges. Since the data registers are 4 bits each, the differentiating number of pulses is 2⁴ or 16, so that Address 0 is signified by 17 rising edges and Address 3 by 20 rising edges. Data is inclusively applied to any number of rising edges between 1 and 16. A typical write protocol is a burst of EN/SET rising edges which signify a particular address, followed by a pause with EN/SET held high for the prescribed t_{LAT} timeout period, a burst of rising edges signifying data, and a t_{LAT} timeout for the data registers. Once an address is set, multiple writes to the corresponding data register are allowed. Address 0 is the default address on the first rising edge after the SKY81279 has been disabled.

When EN/SET is transitioned from high to low and held low longer than t_{OFF} (500 μ s), the SKY81279 enters into the Shutdown mode and draws less than 1 μ A from the input supply. All data and addresses are cleared (reset to 0) during shutdown. AS²Cwire addressing allows for control of the Movie-mode output current and the ratio of Movie-mode current to flash current. If there are no programmed write instructions applied to the EN/SET pin prior to the assertion of the FLEN pin, and the device is enabled, all registers will be loaded with their default values shown in Table 1. In the event that the number of rising edges applied to the EN/SET pin is less than 17, the internal state machine will interpret instruction to program the output currents to the desired current level for Movie-mode operation.

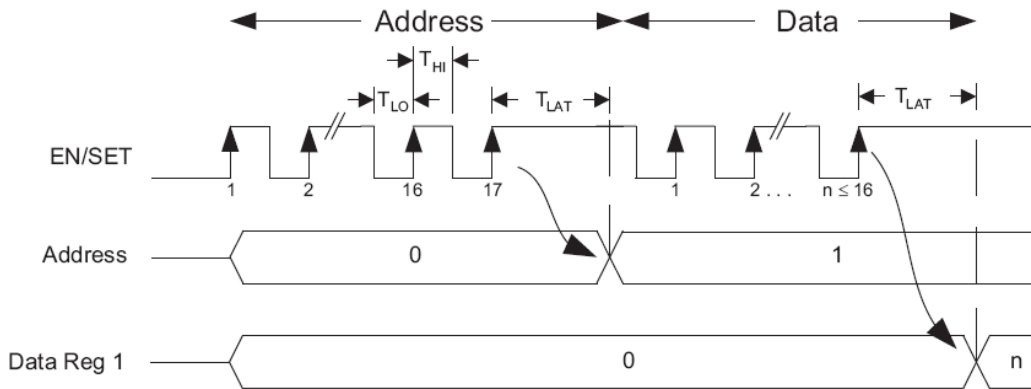

Figure 1: AS²Cwire Serial Interface Timing Diagram.

Address	EN/SET Rising Edges	Function	Default (No Programming)
0	17	Movie Mode Current	100%
1		Unused	
2	19	Output Enable Control	ON
3	20	Flash Current Ratio	100%

Table 1: AS²Cwire Serial Interface Addressing.

1.5A Single Flash LED Driver IC in a TDFN Package**Movie Mode Current – Address 0**

The SKY81279 Movie mode current settings are controlled using the AS²Cwire interface. The ratio between the flash current level and maximum movie mode current level is fixed at 1:7.

For example, if an R_{SET} value of 162kΩ is chosen, then the flash current is set to 1000mA. For Movie mode operation, the maximum current available is as follows:

$$I_{\text{MOVE_MODE}} = \frac{I_{\text{FL(MAX)}}}{7} = \frac{1000\text{mA}}{7} = 143\text{mA}$$

$$I_{\text{FL(MAX)}} = \frac{162\text{k}\Omega}{R_{\text{SET}}} \cdot 1\text{A} = \frac{162\text{k}\Omega}{162\text{k}\Omega} \cdot 1\text{A} = 1\text{A}$$

Address 0 controls precise Movie mode current levels. The Movie mode current can be adjusted in a logarithmic fashion to one of 16 steps represented as a fraction of the maximum Movie mode current in Table 2.

Data	Percentage of Maximum MM Current
1*	100.0%
2	93.7%
3	87.4%
4	81.1%
5	74.8%
6	68.4%
7	62.1%
8	55.8%
9	49.5%
10	43.2%
11	36.9%
12	30.6%
13	24.3%
14	18.0%
15	11.7%
16	5.5%

Table 2: Address 0, Movie Mode (MM) Current Programming.

* Default value.

Output Enable Control – Address 2

To enable or disable the flash, a write instruction to Address 2 is applied to the SKY81279's EN/SET pin. If no write instruction is applied, the default value for Address 2 is ON. During a flash event, LED will be enabled regardless of the Movie-mode setting.

Data	Movie Mode Enable
1	OFF
2	OFF
3	ON
4*	ON

Table 3: Address 2 - Output Enable Control.

* Default value.

Flash Current Ratio – Address 3

During flash start-up, the maximum peaked sustained flash current level is programmable by Address 3. This level is a fraction of the maximum flash current set by R_{SET}. The ratio may be varied from 100% to 62% in 4 steps as shown in Table 4. The default value for Address 3 is Data = 1 and represents a maximum flash current level of 100%.

Data	Maximum Flash Current Ratio
1*	100%
2	84%
3	70%
4	62%

Table 4: Address 3 – Flash Current Ratio, Fraction of Maximum Flash Current Set by R_{SET}.

* Default value.

Shutdown

Since the flash current sink is the only power return path for the flash LED load, there is no leakage current to load if all the sink switches are disabled. When the EN/SET pin is held low for an amount of time greater than t_{OFF} (500μs), the SKY81279 flash boost converter section enters into Shutdown mode and draws less than 1μA from the input power source. All data and address registers for the Flash and/or Movie mode are cleared (reset to 0) during shutdown.

Selecting the Boost Inductor

The SKY81279 controller utilizes PWM control and the switching frequency is fixed. To maintain 2MHz maximum switching frequency and stable operation, a 1μH inductor is recommended. Manufacturer's specifications list both the inductor DC current rating, which is a thermal limitation, and peak inductor current rating, which is determined by the saturation characteristics. Measurements at full load and high ambient temperature should be performed to ensure that the inductor does not saturate or exhibit excessive temperature rise.

1.5A Single Flash LED Driver IC in a TDFN Package**Selecting the Boost Capacitors**

In general, it is good design practice to place a decoupling capacitor (input capacitor) between the IN pin and ground. A 10 μ F or higher input capacitor is recommended. A larger input capacitor in this application may be required for stability, transient response, and/or ripple performance. The high output ripple inherent in the boost converter necessitates the use of low impedance output filtering. Multi-Layer Ceramic (MLC) capacitors provide small size and adequate capacitance, low parasitic Equivalent Series Resistance (ESR) and Equivalent Series Inductance (ESL), and are well suited to use with the SKY81279 boost regulator. MLC capacitors of type X7R or X5R are recommended to ensure good capacitance stability over the full operating temperature range. The output capacitor is selected to maintain the output load without significant voltage droop (ΔV_{OUT}) during the power switch

ON interval. A 2.2 μ F ceramic output capacitor is recommended (see Table 6). Typically, 6.3V or 10V rated capacitors are required for this flash LED boost output application. Ceramic capacitors selected as small as 0603 are available which meet these requirements. MLC capacitors exhibit significant capacitance reduction with applied voltage. Output ripple measurements should confirm that output voltage droop and operating stability are within acceptable limits. Voltage de-rating can minimize this factor, but the results may vary with package size among specific manufacturers. To maintain stable operation at full load, the output capacitor should be selected to maintain ΔV_{OUT} between 100mV and 200mV. The boost converter input current flows during both ON and OFF switching intervals. The input ripple current is less than the output ripple and, as a result, less input capacitance is required.

Manufacturer	Part Number	Inductance (μ H)	Saturated Rated Current (A)	DCR (m Ω)	Size (mm) L \times W \times H	Type
Cooper Bussmann	SD3812-1R0-R	1	2.69	48	4.0 \times 4.0 \times 1.2	shielded drum core
Cooper Bussmann	SDH3812-1R0-R	1	3	45	3.8 \times 3.8 \times 1.2	
Sumida	CDH38D11/S	1	2.69	48	4.0 \times 4.0 \times 1.2	

Table 5: Typical Suggested Surface Mount Inductors.

Manufacturer	Part Number	Capacitance (μ F)	Voltage Rating (V)	Temp Co.	Case Size
Murata	GRM188R60J106ME47	10	6.3	X5R	0603
	GRM188R71A225KE15	2.2	10	X7R	
	GRM21BR70J225KA01	2.2	6.3	X7R	
	GRM21BR71A225KA01	2.2	10	X7R	0805
	GRM219R61A475KE19	4.7	10	X5R	
	GRM21BR71A106KE51	10	10	X7R	

Table 6: Typical Suggested Surface Mount Capacitors.**PCB Layout Guidelines**

the performance of the boost converter can be adversely affected by poor layout. Possible impact includes high input and output voltage ripple, poor EMI performance, and reduced operating efficiency. Every attempt should be made to optimize the layout in order to minimize parasitic PCB effects (stray resistance, capacitance, and inductance) and EMI coupling from the high frequency SW node. A suggested PCB layout for the SKY81279 1.5A step-up regulator is shown in Figures 3 and 4. The following PCB layout guidelines should be considered:

1. Minimize the distance to the PGND pins from the negative terminals of capacitors C_{IN} and C_{OUT} . This is especially true with output capacitor C_{OUT} , which conducts high ripple current from the output to the PGND pin.
2. Minimize the distance under the inductor between IN and switching pin SW; minimize the size of the PCB area connected to the SW pin.
3. Maintain a ground plane and connect it to the IC PGND pin as the PGND connections of C_{IN} and C_{OUT} .
4. Consider additional PCB exposed area for the flash LED to maximize heatsinking capability. This may be necessary when using high current application and long flash duration application.
5. Connect the exposed paddle (bottom of the die) to PGND or GND. Connect AGND, FLGND to GND as close as possible to the package.

SKY81279

1.5A Single Flash LED Driver IC in a TDFN Package

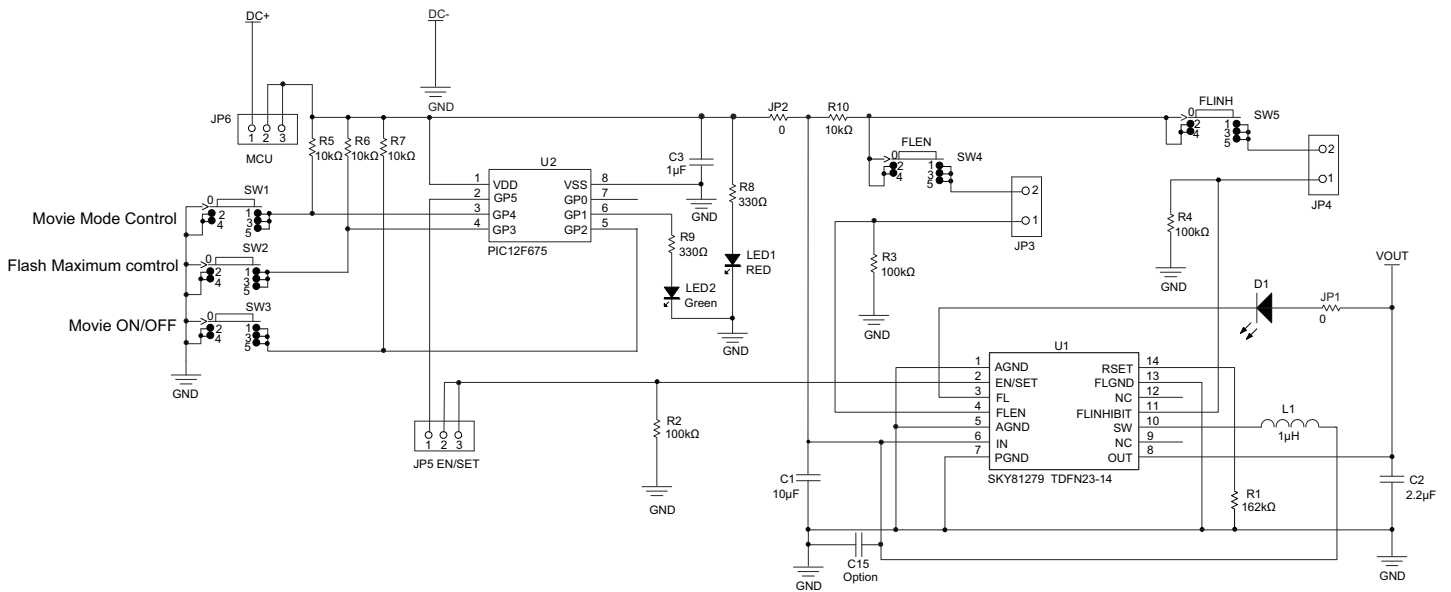
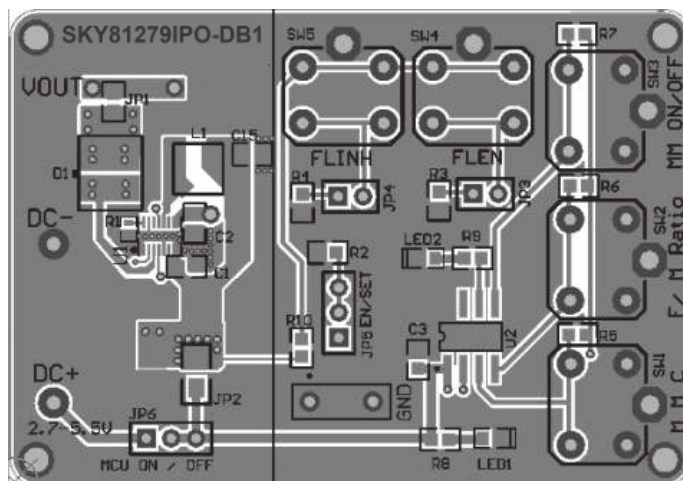
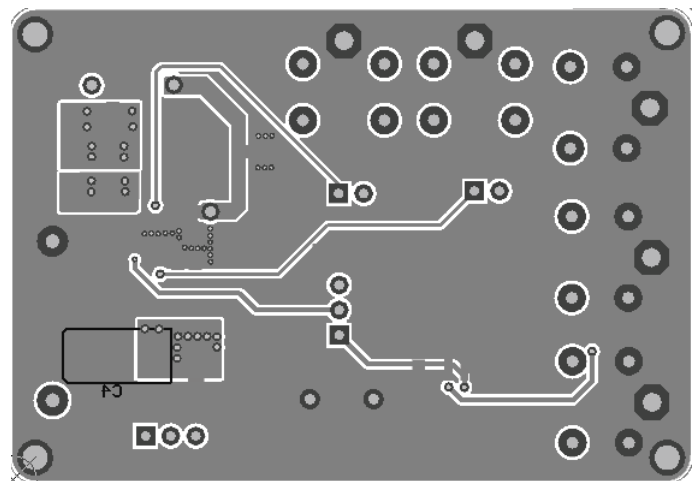

Figure 2: SKY81279 Evaluation Board Schematic.



(a) Top Side.



(b) Bottom Side.

Figure 3: SKY81279 Evaluation Board Top and Bottom Side Layout.

SKY81279***1.5A Single Flash LED Driver IC in a TDFN Package***

Component	Part Number	Description	Manufacturer
U1	SKY81279-11-563LF	1.5A Step-Up Current Regulator for Flash LEDs; TDFN33-14 package	SKYWORKS
U2	PIC12F675	8-bit CMOS, FLASH-based μC ; 8-pin PDIP package	Microchip
SW1 – SW5	PTS645TL50	Switch, SPST, 5mm	ITT Industries
R1	Chip Resistor	162k Ω , 1%, 0402	Vishay
R2, R3, R4	Chip Resistor	100k Ω , 1%, 0603	
R5, R6, R7, R10	Chip Resistor	10k Ω , 1%, 0603	
R8, R9	Chip Resistor	330 Ω , 1%, 0603	
JP1, JP2	Chip Resistor	0 Ω , 1%	
C1	GRM188R60J106ME47	10 μF , 6.3V, X5R, 0603	Murata
C2	GRM188R71A225KE15	2.2 μF , 10V, X7R, 0603	
C3	GRM216R61A105KA01	1 μF , 10V, X5R, 0805	
L1	SD3812-1R0-R	Drum Core, 1 μH , 2.69A, 48m Ω	Cooper Bussmann
D1	SSC-FCW401Z4	White Flash LED	SEOUL
LED1	CMD15-21SRC/TR8	Red LED; 1206	Chicago Miniature Lamp
LED2	CMD15-21VGC/TR8	Green LED; 1206	
JP3, JP4, JP5, JP6	PRPN401PAEN	Conn. Header, 2mm zip	Sullins Electronics

Table 7: SKY81279 Evaluation Board Bill of Materials (BOM).

SKY81279

I.5A Single Flash LED Driver IC in a TDFN Package

Ordering Information

Package	Marking ¹	Manufacturing Part Number	Evaluation Board Part Number
TDFN23-14	SKY11 81279 LLLLL	SKY81279-11-563LF	SKY81279-11-563LF-EVB



Skyworks Green™ products are compliant with all applicable legislation and are halogen-free.

For additional information, refer to *Skyworks Definition of Green™*, document number SQ04-0074.

Package Information³

Typical Case Markings
(Top View)

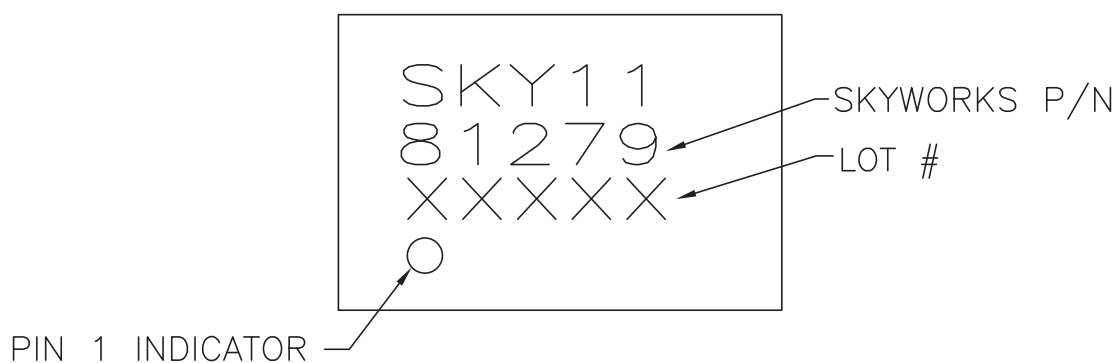

1. LLLLL = Lot number.

SKY81279

1.5A Single Flash LED Driver IC in a TDFN Package

Tape and Reel Dimensions

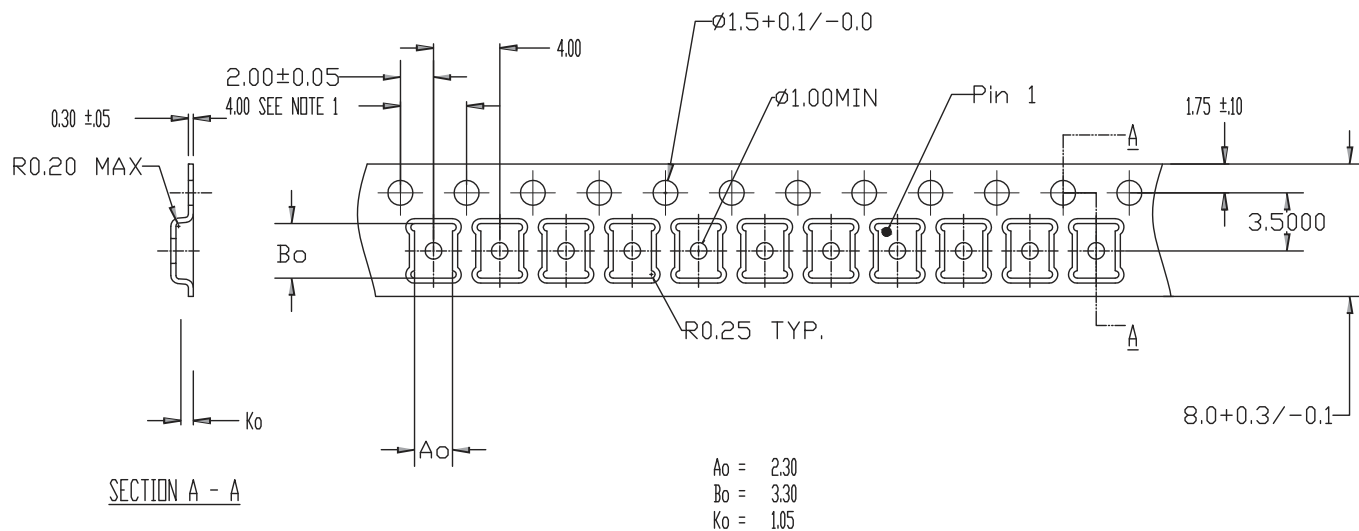

NOTES:

1. SPROCKET HOLE PITCH CUMULATIVE TOLERANCE ± 0.2
2. CARRIER TAPE SHALL BE BLACK CONDUCTIVE POLYSTYRENE.
3. POCKET POSITION RELATIVE TO SPROCKET HOLE MEASURE AS TRUE POSITION OF POCKET, NOT POCKET HOLE
4. CARRIER TAPE MUST MEET ALL REQUIREMENTS OF SKYWORKS GP01-D232 PROCUREMENT SPEC FOR TAPE and REEL SHIPPING.
5. COVER TAPE SHALL BE TRANSPARENT CONDUCTIVE MATERIAL.
6. ESD-SURFACE RESISTIVITY MUST MEET ALL ESD REQUIREMENTS OF SKYWORKS SPECIFIED ON GP01-D232
7. ALL DIMENSIONS ARE IN MILLIMETER.

SKY81279

1.5A Single Flash LED Driver IC in a TDFN Package

TDFN23-14

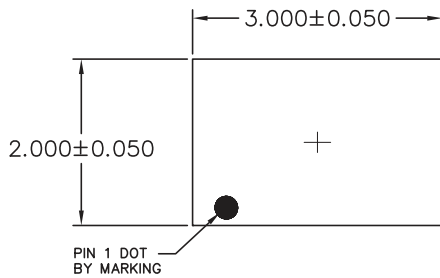

TOP VIEW

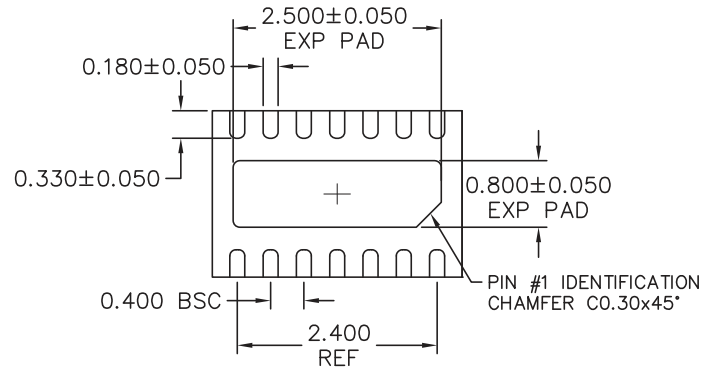

BOTTOM VIEW

		TSLP
A	MAX.	0.800
	NOM.	0.750
	MIN.	0.700

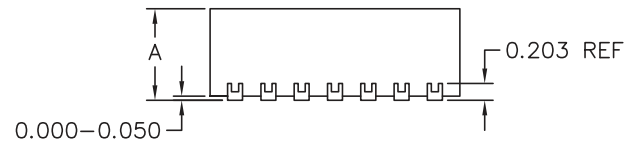

SIDE VIEW

NOTES:

1. PLATING REQUIREMENT PER SOURCE CONTROL DRAWING (SCD) 2504.

DIMENSIONS ARE IN MILLIMETERS
TOLERANCES ON FINISH: RMS 6.3
ANGLES: 15/7° FRACTIONS: 21/64
3 PLACE DECIMALS: ±0.020
2 PLACE DECIMALS: ±0.05
1 PLACE DECIMALS: ±0.1

THIRD ANGLE PROJECTION



LIST OF MATERIAL

OUTLINE: TDFN

14 LEADS, 3 X 2 X 0.75 MM
2.5 X 0.8 MM EXPOSED PADDLE
0.400 MM PITCH

Copyright © 2012, 2013 Skyworks Solutions, Inc. All Rights Reserved.

Information in this document is provided in connection with Skyworks Solutions, Inc. ("Skyworks") products or services. These materials, including the information contained herein, are provided by Skyworks as a service to its customers and may be used for informational purposes only by the customer. Skyworks assumes no responsibility for errors or omissions in these materials or the information contained herein. Skyworks may change its documentation, products, services, specifications or product descriptions at any time, without notice. Skyworks makes no commitment to update the materials or information and shall have no responsibility whatsoever for conflicts, incompatibilities, or other difficulties arising from any future changes.

No license, whether express, implied, by estoppel or otherwise, is granted to any intellectual property rights by this document. Skyworks assumes no liability for any materials, products or information provided hereunder, including the sale, distribution, reproduction or use of Skyworks products, information or materials, except as may be provided in Skyworks Terms and Conditions of Sale.

THE MATERIALS, PRODUCTS AND INFORMATION ARE PROVIDED "AS IS" WITHOUT WARRANTY OF ANY KIND, WHETHER EXPRESS, IMPLIED, STATUTORY, OR OTHERWISE, INCLUDING FITNESS FOR A PARTICULAR PURPOSE OR USE, MERCHANTABILITY, PERFORMANCE, QUALITY OR NON-INFRINGEMENT OF ANY INTELLECTUAL PROPERTY RIGHT; ALL SUCH WARRANTIES ARE HEREBY EXPRESSLY DISCLAIMED. SKYWORKS DOES NOT WARRANT THE ACCURACY OR COMPLETENESS OF THE INFORMATION, TEXT, GRAPHICS OR OTHER ITEMS CONTAINED WITHIN THESE MATERIALS. SKYWORKS SHALL NOT BE LIABLE FOR ANY DAMAGES, INCLUDING BUT NOT LIMITED TO ANY SPECIAL, INDIRECT, INCIDENTAL, STATUTORY, OR CONSEQUENTIAL DAMAGES, INCLUDING WITHOUT LIMITATION, LOST REVENUES OR LOST PROFITS THAT MAY RESULT FROM THE USE OF THE MATERIALS OR INFORMATION, WHETHER OR NOT THE RECIPIENT OF MATERIALS HAS BEEN ADVISED OF THE POSSIBILITY OF SUCH DAMAGE.

Skyworks products are not intended for use in medical, lifesaving or life-sustaining applications, or other equipment in which the failure of the Skyworks products could lead to personal injury, death, physical or environmental damage. Skyworks customers using or selling Skyworks products for use in such applications do so at their own risk and agree to fully indemnify Skyworks for any damages resulting from such improper use or sale.

Customers are responsible for their products and applications using Skyworks products, which may deviate from published specifications as a result of design defects, errors, or operation of products outside of published parameters or design specifications. Customers should include design and operating safeguards to minimize these and other risks. Skyworks assumes no liability for applications assistance, customer product design, or damage to any equipment resulting from the use of Skyworks products outside of stated published specifications or parameters.

Skyworks, the Skyworks symbol, and "Breakthrough Simplicity" are trademarks or registered trademarks of Skyworks Solutions, Inc., in the United States and other countries. Third-party brands and names are for identification purposes only, and are the property of their respective owners. Additional information, including relevant terms and conditions, posted at www.skyworksinc.com, are incorporated by reference.