

 EVALUATION KIT  
AVAILABLE

# SAS/SATA Single Lane 2:1/1:2 Multiplexer/ Demultiplexer Plus Redriver with Equalization

MAX4986

## General Description

The MAX4986 active 2:1/1:2 multiplexer/demultiplexer equalizes and redrives SAS/SATA or SATA-only signals up to 6.0Gbps and operates from a single +3.3V supply.

The MAX4986 features independent input equalization and output preemphasis. The MAX4986 enhances signal integrity at the receiver by equalizing the signal at the input and establishing preemphasis at the output of the device. SAS/SATA and SATA-only out-of-band (OOB) signaling is supported using high-speed amplitude detection on the inputs and squelch on the corresponding outputs. Inputs and outputs are internally 50Ω terminated and must be AC-coupled to the SAS/SATA controller IC and SAS/SATA device.

The MAX4986 is available in a small (3.5mm x 9.0mm), 42-pin TQFN package optimal for simplified layout and space-saving requirements. The MAX4986C is specified over the 0°C to +70°C commercial operating temperature range. The MAX4986E is specified over the -40°C to +85°C extended temperature range.

## Applications

PC Servers  
Workstations  
Desktops  
Docking Stations

## Features

- ◆ Single +3.3V Supply Operation
- ◆ Low-Power, 1mA (typ) Standby
  - Active-High Enable (EN) for Use with Power Good
  - Active-Low Enable (EN) for Cable-Detect Function
- ◆ Supports SAS I/II/III ≤ 6.0Gbps
- ◆ Independent Programmable Input Equalization
  - Two Levels: 0dB, 4dB
- ◆ Independent Programmable Output Preemphasis
  - Two Levels: 0dB, 3dB
- ◆ Independent Programmable Output Level Selection
- ◆ Supports SAS/SATA OOB-Level Signaling
  - Programmable SAS/SATA Threshold
- ◆ Cable-Detect Feature for Low Power Consumption
- ◆ On-Chip 50Ω Input/Output Terminations
- ◆ Inline Signal Traces for Simplified Layout
- ◆ Space-Saving, 3.5mm x 9.0mm TQFN Package with Exposed Pad

## Ordering Information

PART	TEMP RANGE	PIN-PACKAGE
MAX4986CTO+	0°C to +70°C	42 TQFN-EP*
MAX4986ETO+	-40°C to +85°C	42 TQFN-EP*

+Denotes a lead(Pb)-free/RoHS-compliant package.

\*EP = Exposed pad.

# SAS/SATA Single Lane 2:1/1:2 Multiplexer/ Demultiplexer Plus Redriver with Equalization

## ABSOLUTE MAXIMUM RATINGS

(Voltages Referenced to GND.)

VCC	-0.3V to +4.0V
All Other Pins (Note 1)	-0.3V to (VCC + 0.3V)
Continuous Current IN_P, IN_M, OUT_P, OUT_M	±30mA
Peak Current IN_P, IN_M, OUT_P, OUT_M for 1µs	±100mA
Continuous Power Dissipation (T <sub>A</sub> = +70°C)	
42-Pin TQFN (derate 34.5mW/°C above +70°C)	2758mW

Operating Temperature Range	-40°C to +85°C
Junction Temperature Range	-40°C to +150°C
Storage Temperature Range	-65°C to +150°C
Lead Temperature (soldering, 10s)	+300°C
Soldering Temperature (reflow)	+260°C

**Note 1:** All I/O pins are clamped by internal diodes.

Stresses beyond those listed under "Absolute Maximum Ratings" may cause permanent damage to the device. These are stress ratings only, and functional operation of the device at these or any other conditions beyond those indicated in the operational sections of the specifications is not implied. Exposure to absolute maximum rating conditions for extended periods may affect device reliability.

## ELECTRICAL CHARACTERISTICS

(V<sub>CC</sub> = +3.0V to +3.6V, C<sub>CL</sub> = 10nF coupling capacitor on each input and output, R<sub>L</sub> = 50Ω on each input and output, T<sub>A</sub> = 0°C to +70°C (MAX4986C), T<sub>A</sub> = -40°C to +85°C (MAX4986E), unless otherwise noted. Typical values are at V<sub>CC</sub> = +3.3V and T<sub>A</sub> = +25°C.) (Note 2)

PARAMETER	SYMBOL	CONDITIONS	MIN	TYP	MAX	UNITS
<b>DC PERFORMANCE</b>						
Power-Supply Range	V <sub>CC</sub>		3.0		3.6	V
Standby Current	I <sub>STBY</sub>	EN = 0 or $\overline{EN}$ = 1, V <sub>CC</sub> = 3.6V		2.5	4	mA
		EN = 0 or $\overline{EN}$ = 1, V <sub>CC</sub> = 3.3V		1.0	2	
Supply Current	I <sub>CC</sub>	OUTPE = PEA = PEB = 0, INEQ = EQA = EQB = 0		145	170	mA
		OUTPE = PEA = PEB = 1, INEQ = EQA = EQB = 1		185	230	
Input Termination, Single-Ended	R <sub>RX-SE</sub>	DC	42.5		57.5	Ω
Output Termination, Single-Ended	R <sub>TX-SE</sub>	DC	42.5		57.5	Ω
<b>AC PERFORMANCE</b>						
Input Return Loss, Differential (Note 3)	SDD11	0.1GHz < f ≤ 0.3GHz			-10	dB
		0.3GHz < f ≤ 3.0GHz			-7.9	
		3.0GHz < f ≤ 6.0GHz			0	
Input Return Loss, Common Mode (Note 3)	SCC11	0.1GHz < f ≤ 0.3GHz			-6	dB
		0.3GHz < f ≤ 3.0GHz			-5	
		3.0GHz < f ≤ 6.0GHz			0	
Output Return Loss, Differential (Note 3)	SDD22	0.1GHz < f ≤ 0.3GHz			-10	dB
		0.3GHz < f ≤ 3.0GHz			-7.9	
		3.0GHz < f ≤ 6.0GHz			0	
Output Return Loss, Common Mode (Note 3)	SCC22	0.1GHz < f ≤ 0.3GHz			-6	dB
		0.3GHz < f ≤ 3.0GHz			-5	
		3.0GHz < f ≤ 6.0GHz			0	
Differential Input Voltage	V <sub>IN-DIFF</sub>	SAS 1.5Gbps, 3Gbps, MODE_ = 0	275		1600	mV <sub>P-P</sub>
		SAS 6Gbps, MODE_ = 0	300		1600	
		SATA 1.5Gbps, 3Gbps, 6Gbps, MODE_ = 1	225		1600	
Input Equalization	EQ	f = 1.5GHz, INEQ = 1		4		dB
Differential Output Voltage	V <sub>OUT-DIFF</sub>	f = 0.75GHz, 1.5GHz, PE_ = 0	OAMP_ = 0	700	1200	mV <sub>P-P</sub>
			OAMP_ = 1	425	700	

# SAS/SATA Single Lane 2:1/1:2 Multiplexer/ Demultiplexer Plus Redriver with Equalization

## ELECTRICAL CHARACTERISTICS (continued)

(V<sub>CC</sub> = +3.0V to +3.6V, C<sub>CL</sub> = 10nF coupling capacitor on each input and output, R<sub>L</sub> = 50Ω on each input and output, T<sub>A</sub> = 0°C to +70°C (MAX4986C), T<sub>A</sub> = -40°C to +85°C (MAX4986E), unless otherwise noted. Typical values are at V<sub>CC</sub> = +3.3V and T<sub>A</sub> = +25°C.) (Note 2)

PARAMETER	SYMBOL	CONDITIONS	MIN	TYP	MAX	UNITS
Output Preemphasis	PE	f = 1.5GHz, PE_ = 1, Figure 1		3		dB
Propagation Delay	t <sub>PD</sub>			300		ps
Output Transition Time	t <sub>TX-RF</sub>	f < 3.0GHz, PE_ = 0 (Notes 3, 4)	40	60		ps
Differential Output Skew Same Pair	t <sub>SK</sub>			10		ps
Deterministic Jitter	t <sub>DJ</sub>	K28.5± pattern, PE_ = 0, EQ_ = 0 (Note 3)			20	psp-P
Random Jitter	t <sub>TX-RJ-DD</sub>	D10.2 pattern, PE_ = 0, EQ_ = 0		1	1.5	psRMS
OOB Squelch Threshold	V <sub>SQ-DIFF</sub>	f = 0.75GHz (Note 3)	MODE_ = 0	120	220	mVP-P
			MODE_ = 1	50	150	
OOB Squelch Time	t <sub>OOB,SQ</sub>	f = 0.75GHz (Note 3)		5	10	ns
OOB Exit Time	t <sub>OOB,EX</sub>	f = 0.75GHz (Note 3)		5	10	ns
OOB Differential-Offset Delta	ΔV <sub>OOB,DIFF</sub>	Difference between OOB and active-mode output offset	-80		80	mV
OOB Common-Mode Delta	ΔV <sub>OOB,CM</sub>	Difference between OOB and active-mode output V <sub>CM</sub>	-50		50	mV
OOB Output Disable	V <sub>OOB,OUT</sub>	OOB-disabled output level			30	mVP-P
<b>CONTROL LOGIC</b>						
Input Logic-High	V <sub>IH</sub>		1.4			V
Input Logic-Low	V <sub>IL</sub>				0.6	V
Input Logic Hysteresis	V <sub>HYST</sub>			0.1		V
Pullup/Pulldown Input Resistor	R <sub>UP/DOWN</sub>			330		kΩ

**Note 2:** MAX4986C devices are 100% production tested at T<sub>A</sub> = +70°C. MAX4986E devices are 100% production tested at T<sub>A</sub> = +85°C. Specifications for all temperature limits are guaranteed by design.

**Note 3:** Guaranteed by design.

**Note 4:** Rise and fall times are measured using 20% and 80% levels.

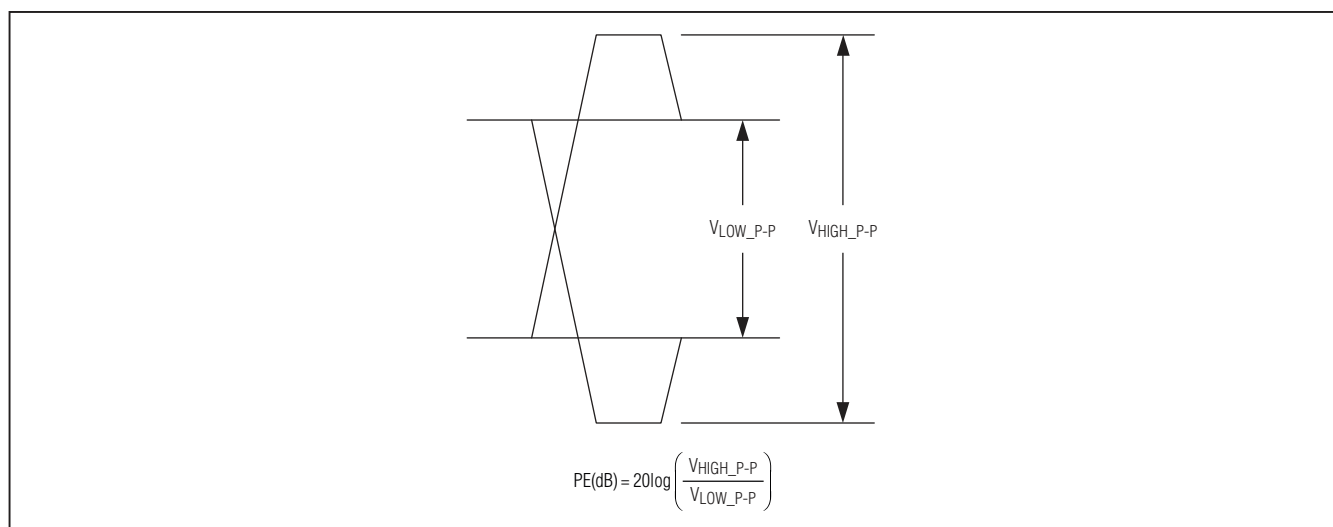
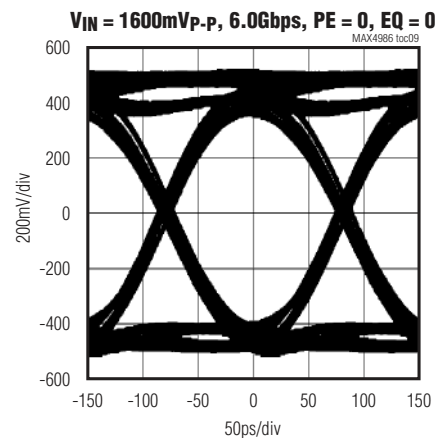
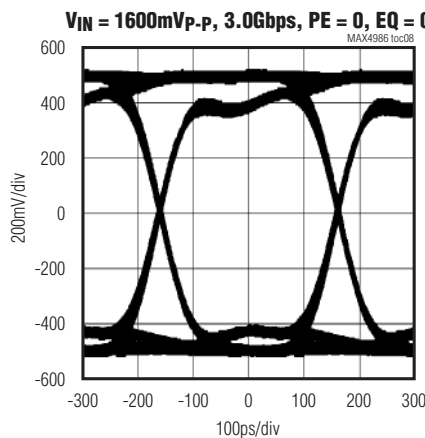
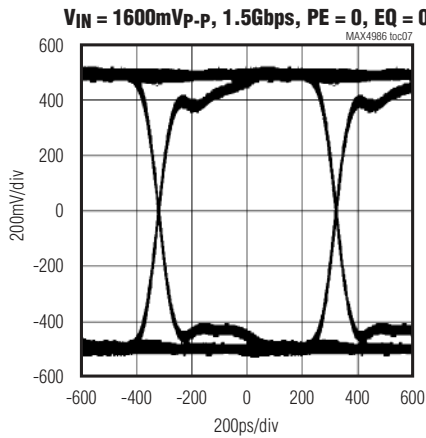
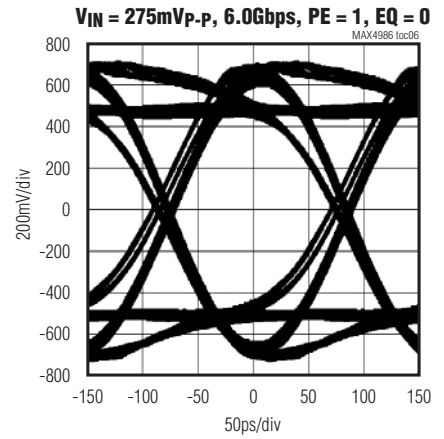
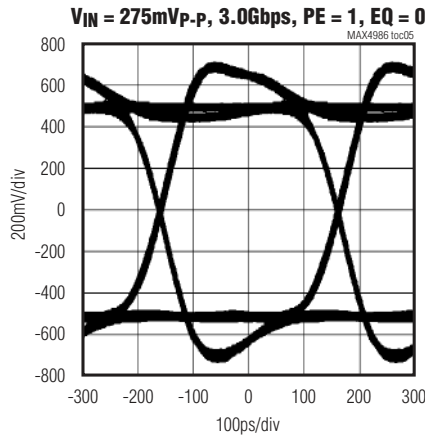
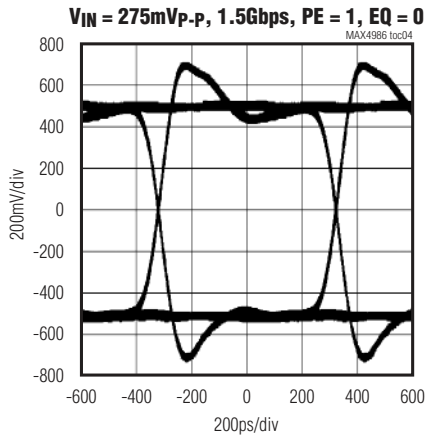
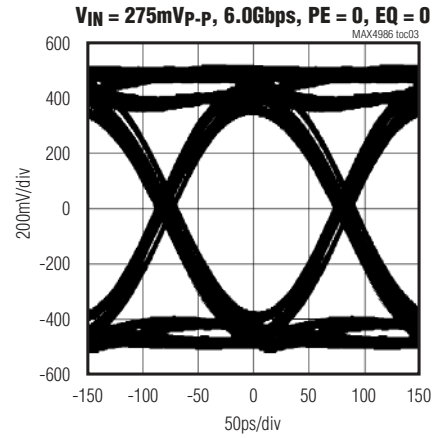
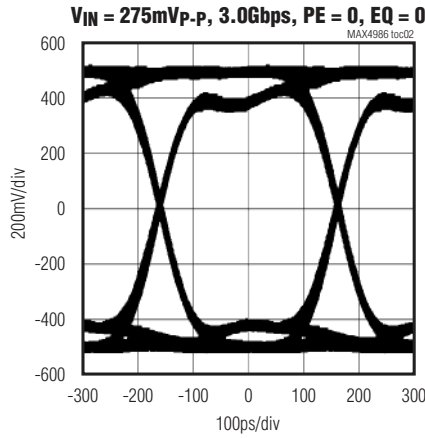
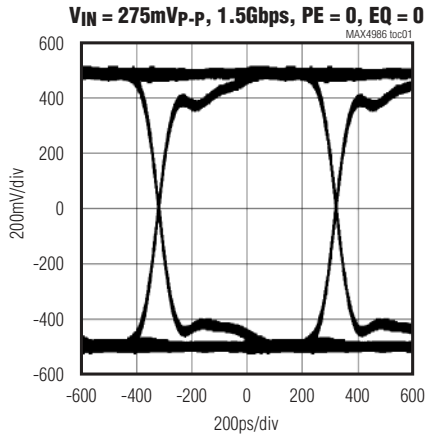

Figure 1. Output Preemphasis

# SAS/SATA Single Lane 2:1/1:2 Multiplexer/ Demultiplexer Plus Redriver with Equalization

## Typical Operating Characteristics

(T<sub>A</sub> = +25°C, unless otherwise noted.)



# SAS/SATA Single Lane 2:1/1:2 Multiplexer/ Demultiplexer Plus Redriver with Equalization

## Typical Operating Characteristics (continued)

(T<sub>A</sub> = +25°C, unless otherwise noted.)

MAX4986

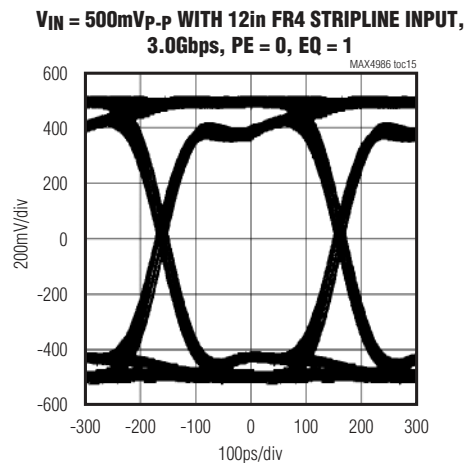
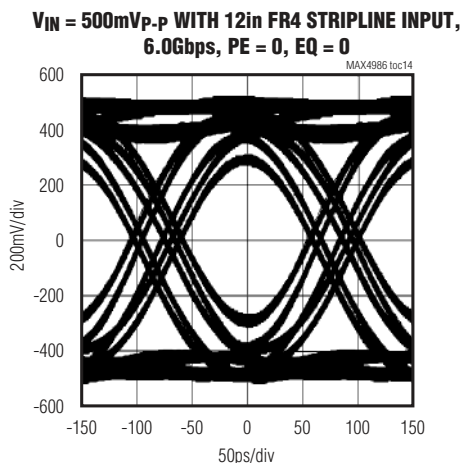
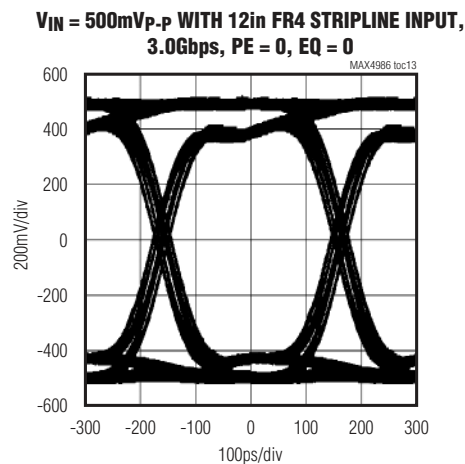
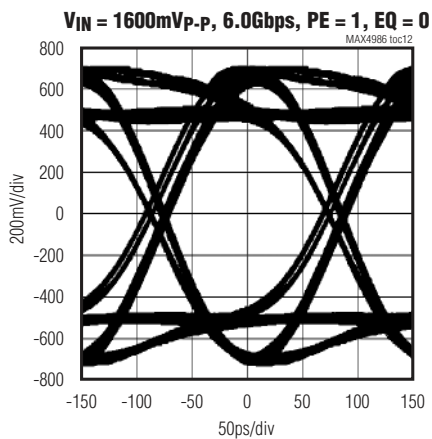
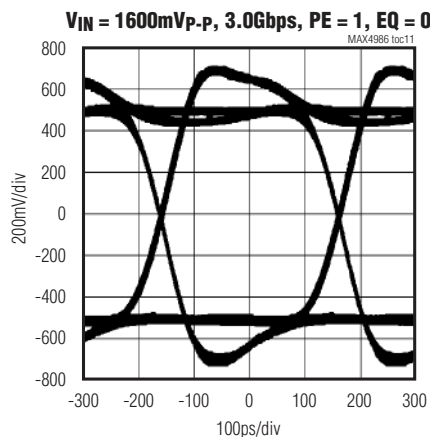
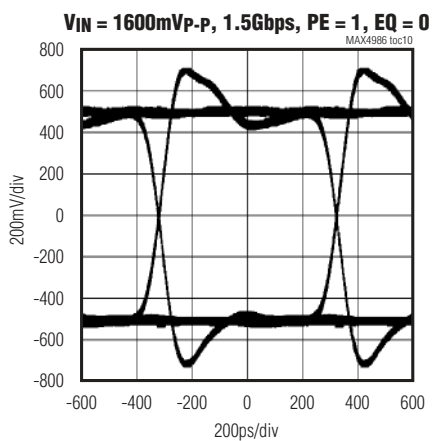

# SAS/SATA Single Lane 2:1/1:2 Multiplexer/ Demultiplexer Plus Redriver with Equalization

## Typical Operating Characteristics (continued)

(T<sub>A</sub> = +25°C, unless otherwise noted.)

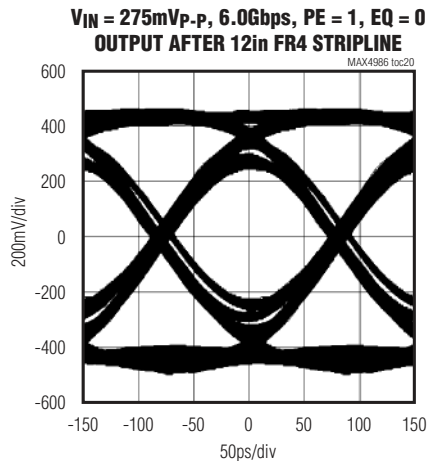
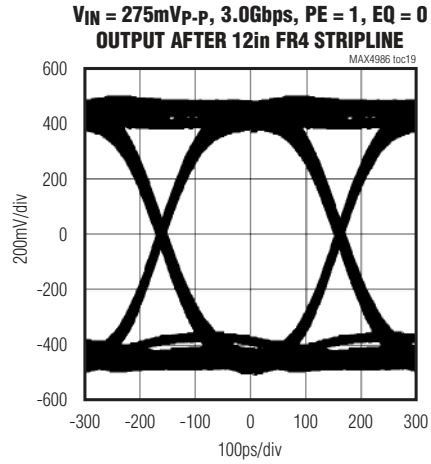
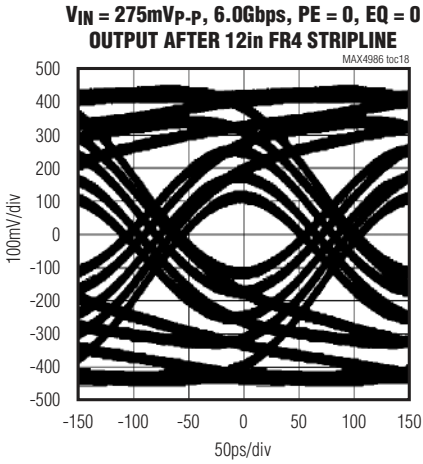
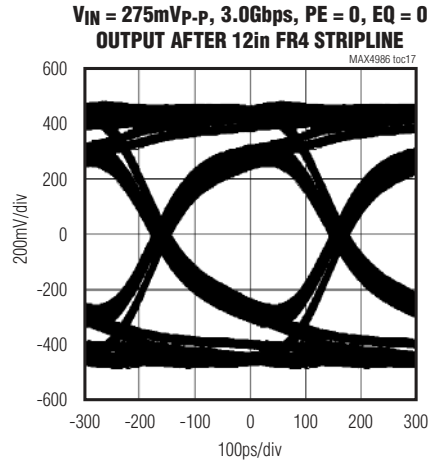
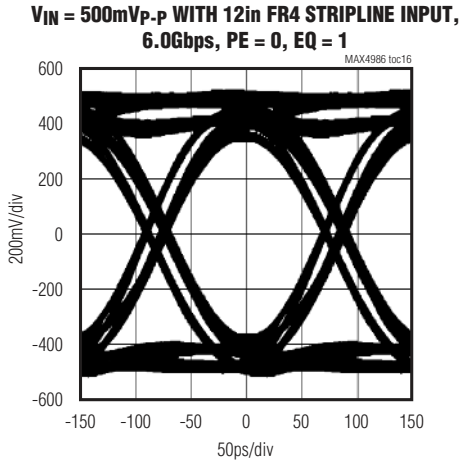

# SAS/SATA Single Lane 2:1/1:2 Multiplexer/ Demultiplexer Plus Redriver with Equalization

## Pin Configuration

**MAX4986**

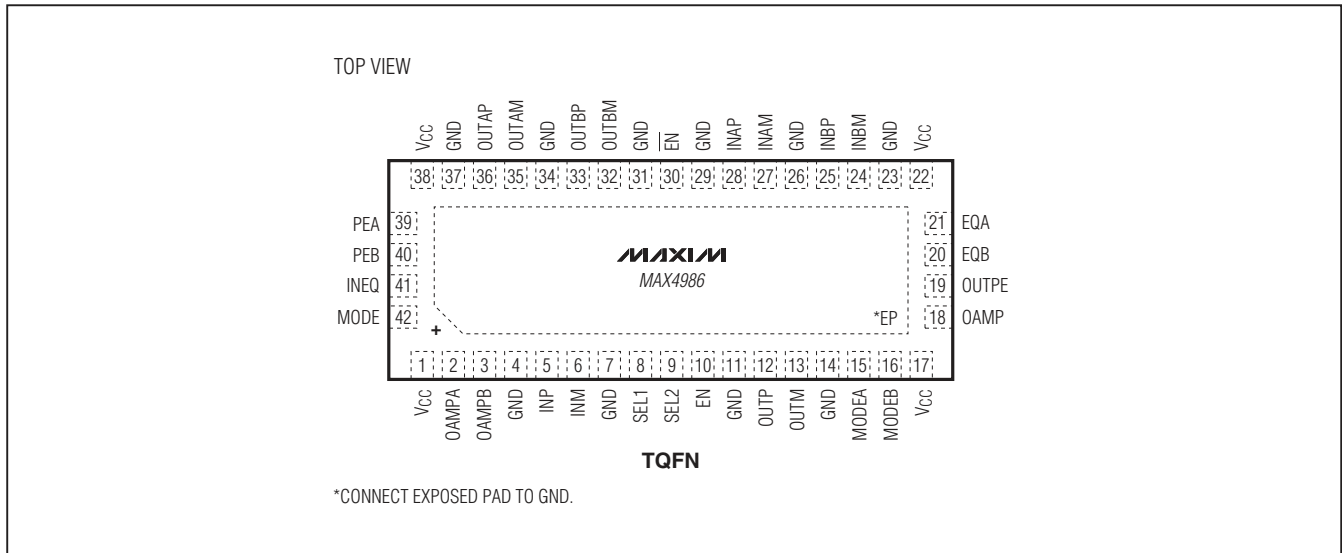

## Pin Description

PIN	NAME	FUNCTION
1, 17, 22, 38	VCC	Power-Supply Input. Bypass VCC to GND with 1 $\mu$ F and 0.01 $\mu$ F capacitors in parallel as close to the device as possible; recommended for each VCC pin.
2	OAMPA	OUTAP/OUTAM Output Level Selection. Drive OAMPA high for low output amplitude. Drive OAMPA low or leave unconnected for high output amplitude. See the <i>Electrical Characteristics</i> table. OAMPA is internally pulled down by a 330k $\Omega$ (typ) resistor.
3	OAMPB	OUTBP/OUTBM Output Level Selection. Drive OAMPB high for low output amplitude. Drive OAMPB low or leave unconnected for high output amplitude. See the <i>Electrical Characteristics</i> table. OAMPB is internally pulled down by a 330k $\Omega$ (typ) resistor.
4, 7, 11, 14, 23, 26, 29, 31, 34, 37	GND	Ground
5	INP	Channel 1 Noninverting Input
6	INM	Channel 1 Inverting Input
8	SEL1	Channel 1 Active-Output Selection Input. Drive SEL1 low or leave unconnected to activate A outputs. Drive SEL1 high to activate B outputs. SEL1 is internally pulled down by a 330k $\Omega$ (typ) resistor.
9	SEL2	Channel 2 Active-Input Selection Input. Drive SEL2 low or leave unconnected to activate A inputs. Drive SEL2 high to activate B inputs. SEL2 is internally pulled down by a 330k $\Omega$ (typ) resistor.
10	EN	Enable Input. Drive EN low or leave unconnected for reduced power standby mode. Drive EN high for normal operation. See Table 1. EN is internally pulled down by a 330k $\Omega$ (typ) resistor.
12	OUTP	Channel 2 Noninverting Output
13	OUTM	Channel 2 Inverting Output

# SAS/SATA Single Lane 2:1/1:2 Multiplexer/ Demultiplexer Plus Redriver with Equalization

## Pin Description (continued)

PIN	NAME	FUNCTION
15	MODEA	INAP/INAM OOB-Mode Logic Input. Drive MODEA low or leave unconnected for SAS OOB threshold. Drive MODEA high for SATA OOB threshold. MODEA is internally pulled down by a 330k $\Omega$ (typ) resistor.
16	MODEB	INBP/INBM OOB-Mode Logic Input. Drive MODEB low or leave unconnected for SAS OOB threshold. Drive MODEB high for SATA OOB threshold. MODEB is internally pulled down by a 330k $\Omega$ (typ) resistor.
18	OAMP	OUTP/OUTM Output Level Selection. Drive OAMP high for low output amplitude. Drive OAMP low or leave unconnected for high output amplitude. See the <i>Electrical Characteristics</i> table. OAMP is internally pulled down by a 330k $\Omega$ (typ) resistor.
19	OUTPE	OUTP/OUTM Output Preemphasis Logic Input. Drive OUTPE low or leave unconnected for no output preemphasis. Drive OUTPE high for 3dB (typ) output preemphasis. OUTPE is internally pulled down by a 330k $\Omega$ (typ) resistor.
20	EQB	INBP/INBM Input Equalization Logic Input. Drive EQB low or leave unconnected for no input equalization. Drive EQB high for 4dB (typ) input equalization. EQB is internally pulled down by a 330k $\Omega$ (typ) resistor.
21	EQA	INAP/INAM Input Equalization Logic Input. Drive EQA low or leave unconnected for no input equalization. Drive EQA high for 4dB (typ) input equalization. EQA is internally pulled down by a 330k $\Omega$ (typ) resistor.
24	INBM	Channel 2 Inverting Input B
25	INBP	Channel 2 Noninverting Input B
27	INAM	Channel 2 Inverting Input A
28	INAP	Channel 2 Noninverting Input A
30	$\overline{\text{EN}}$	Active-Low Enable Input. Drive $\overline{\text{EN}}$ high or leave unconnected for reduced power standby mode. Drive $\overline{\text{EN}}$ low for normal operation. See Table 1. $\overline{\text{EN}}$ is internally pulled up by a 330k $\Omega$ (typ) resistor.
32	OUTBM	Channel 1 Inverting Output B
33	OUTBP	Channel 1 Noninverting Output B
35	OUTAM	Channel 1 Inverting Output A
36	OUTAP	Channel 1 Noninverting Output A
39	PEA	OUTAP/OUTAM Output Preemphasis Logic Input. Drive PEA low or leave unconnected for no output preemphasis. Drive PEA high for 3dB (typ) output preemphasis. PEA is internally pulled down by a 330k $\Omega$ (typ) resistor.
40	PEB	OUTBP/OUTBM Output Preemphasis Logic Input. Drive PEB low or leave unconnected for no output preemphasis. Drive PEB high for 3dB (typ) output preemphasis. PEB is internally pulled down by a 330k $\Omega$ (typ) resistor.
41	INEQ	INP/INM Input Equalization Logic Input. Drive INEQ low or leave unconnected for no input equalization. Drive INEQ high for 4dB (typ) input equalization. INEQ is internally pulled down by a 330k $\Omega$ (typ) resistor.
42	MODE	INP/INM OOB-Mode Logic Input. Drive MODE low or leave unconnected for SAS OOB threshold. Drive MODE high for SATA OOB threshold. MODE is internally pulled down by a 330k $\Omega$ (typ) resistor.
—	EP	Exposed Pad. Internally connected to GND. Connect EP to a large ground plane to maximize thermal performance.



# SAS/SATA Single Lane 2:1/1:2 Multiplexer/ Demultiplexer Plus Redriver with Equalization

## Functional Diagram

**MAX4986**

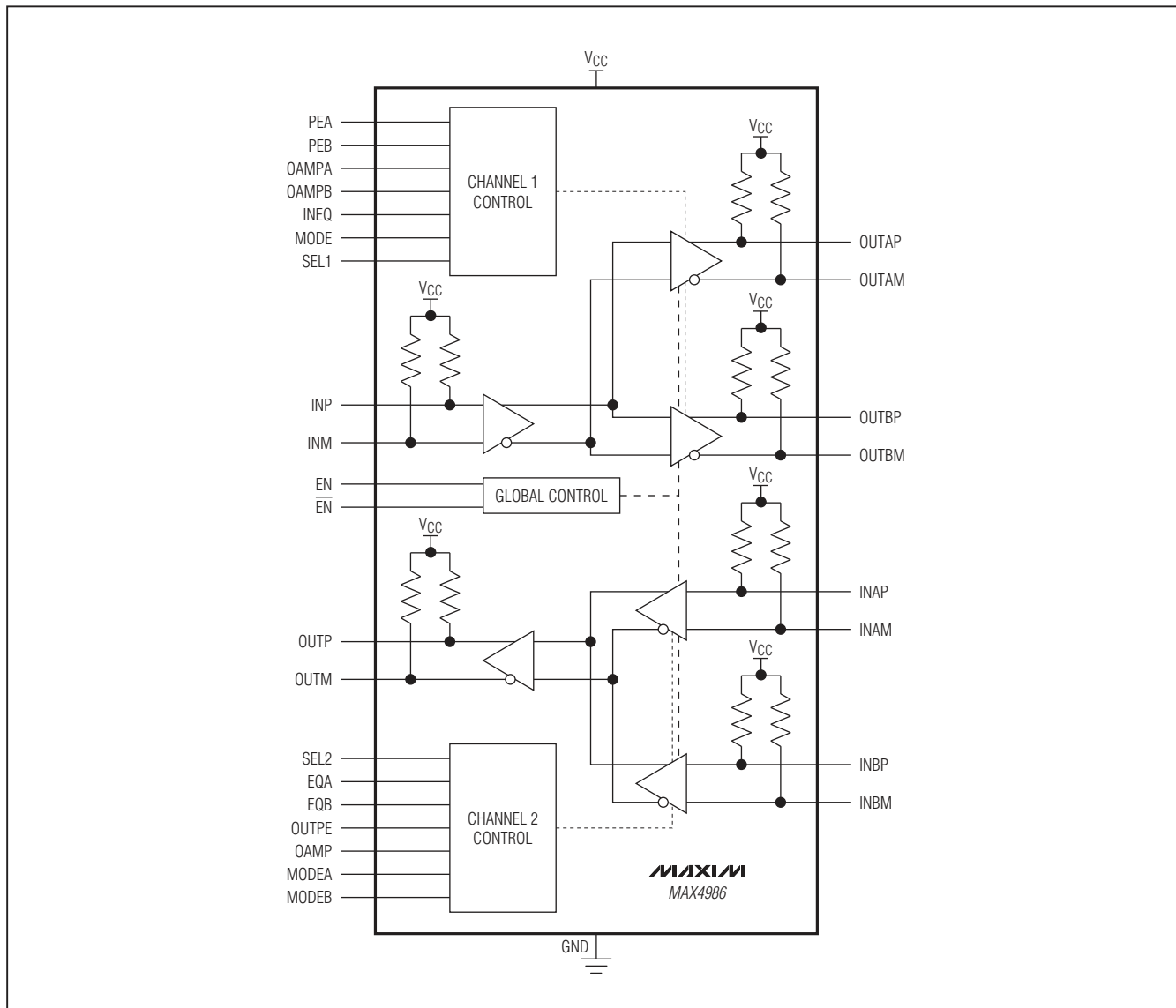

# SAS/SATA Single Lane 2:1/1:2 Multiplexer/ Demultiplexer Plus Redriver with Equalization

## Detailed Description

The MAX4986 is an active 2:1/1:2 multiplexer/demultiplexer designed to equalize and redrive SAS/SATA (Enterprise Class, SATA \_X) or SATA-only signals up to 6.0Gbps.

### Input/Output Terminations

Inputs and outputs are internally  $50\Omega$  terminated to VCC and must be AC-coupled using low-ESR, X7R, 10nF capacitors to the SAS/SATA controller IC and SAS/SATA device for proper operation.

### Enable Inputs (EN, $\overline{EN}$ )

The MAX4986 features both an active-high enable input (EN) and an active-low enable input ( $\overline{EN}$ ). EN has an internal pulldown resistor of  $330k\Omega$  (typ), and  $\overline{EN}$  has an internal pullup resistor of  $330k\Omega$  (typ). When EN is driven low or left unconnected, or when  $\overline{EN}$  is driven high or

left unconnected, the MAX4986 enters reduced power standby mode and the redrivers are disabled. In standby mode, supply current is reduced to  $350\mu A$  (typ). Drive EN high and  $\overline{EN}$  low for normal operation. See Table 1.  $\overline{EN}$  is useful as an automated cable-detect. See the *Typical Application Circuits*.

### Active Input/Output Select (SEL1, SEL2)

SEL1 selects the active output for channel 1 and SEL2 selects the active input for channel 2. Drive SEL1 or SEL2 low or leave unconnected to activate A inputs or outputs. Drive SEL1 or SEL2 high to activate B inputs or outputs. See Table 2. SEL1 and SEL2 have internal pulldown resistors of  $330k\Omega$  (typ).

### Programmable Output Preemphasis (OUTPE, PEA, PEB)

The MAX4986 features independent output preemphasis capable of providing 3dB preemphasis on each channel. When OUTPE, PEA, or PEB are driven low or left unconnected, the corresponding output has no preemphasis. When OUTPE, PEA, or PEB are driven high, the corresponding output has 3dB preemphasis. See Table 3. OUTPE, PEA, and PEB have internal pulldown resistors of  $330k\Omega$  (typ). Output preemphasis should be used when driving long traces or cables.

### Programmable Input Equalization (INEQ, EQA, EQB)

The MAX4986 features independent input equalization capable of providing 4dB of high-frequency equalization on each channel. When INEQ, EQA, or EQB are driven low or left unconnected, the corresponding input has no equalization. When INEQ, EQA, or EQB are driven high, the corresponding input has 4dB equalization. See Table 4. INEQ, EQA, and EQB have internal pulldown resistors of  $330k\Omega$  (typ). Input equalization should be used for long traces or cables.

**Table 1. Standby Mode**

EN	$\overline{EN}$	STATUS
0	X	Reduced Power Standby
X	1	Reduced Power Standby
1	0	Active

X = Don't care.

**Table 2. Active Input/Output Select**

SEL1	SEL2	ACTIVE OUTPUT	ACTIVE INPUT
X	0	X	INAP/INAM
X	1	X	INBP/INBM
0	X	OUTAP/OUTAM	X
1	X	OUTBP/OUTBM	X

X = Don't care.

**Table 3. Output Preemphasis**

OUTPE	PEA	PEB	OUTP/OUTM	OUTAP/OUTAM	OUTBP/OUTBM
0	X	X	0dB	X	X
1	X	X	3dB	X	X
X	0	X	X	0dB	X
X	1	X	X	3dB	X
X	X	0	X	X	0dB
X	X	1	X	X	3dB

X = Don't care.

# SAS/SATA Single Lane 2:1/1:2 Multiplexer/ Demultiplexer Plus Redriver with Equalization

**Table 4. Input Equalization**

INEQ	EQA	EQB	INP/INM	INAP/INAM	INBP/INBM
0	X	X	0dB	X	X
1	X	X	4dB	X	X
X	0	X	X	0dB	X
X	1	X	X	4dB	X
X	X	0	X	X	0dB
X	X	1	X	X	4dB

X = Don't care.

**Table 5. OOB Mode Select**

MODE	MODEA	MODEB	INP/INM	INAP/INAM	INBP/INBM
0	X	X	SAS	X	X
1	X	X	SATA	X	X
X	0	X	X	SAS	X
X	1	X	X	SATA	X
X	X	0	X	X	SAS
X	X	1	X	X	SATA

X = Don't care.

**Table 6. Output Amplitude Selection**

OAMP	OAMPA	OAMPB	OUTP/OUTM	OUTAP/OUTAM	OUTBP/OUTBM
0	X	X	HIGH*	X	X
1	X	X	LOW*	X	X
X	0	X	X	HIGH*	X
X	1	X	X	LOW*	X
X	X	0	X	X	HIGH*
X	X	1	X	X	LOW*

X = Don't care.

\*See the Electrical Characteristics table.

## SAS/SATA Mode Inputs (MODE, MODEA, MODEB)

The MAX4986 supports both SAS and SATA OOB levels. When MODE, MODEA, or MODEB are driven low or left unconnected, the corresponding input's OOB threshold is 120mV<sub>P-P</sub> (min) (SAS mode). When MODE, MODEA, or MODEB are driven high, the corresponding input's OOB threshold is 50mV<sub>P-P</sub> (min) (SATA mode). Signals below the OOB threshold are squelched to prevent unwanted noise from being redriven at the output. See Table 5. MODE, MODEA, and MODEB have internal pull-down resistors of 330k $\Omega$  (typ).

## Output Amplitude Selection Inputs (OAMP, OAMPA, OAMPB)

The MAX4986 features independent output amplitude selection. When OAMP, OAMPA, or OAMPB are driven high, the corresponding output amplitude is low. When OAMP, OAMPA, or OAMPB are driven low or left unconnected, the corresponding output amplitude is high. See Table 6. OAMP, OAMPA, and OAMPB have internal pulldown resistors of 330k $\Omega$  (typ).

# SAS/SATA Single Lane 2:1/1:2 Multiplexer/ Demultiplexer Plus Redriver with Equalization

## Typical Application Circuits

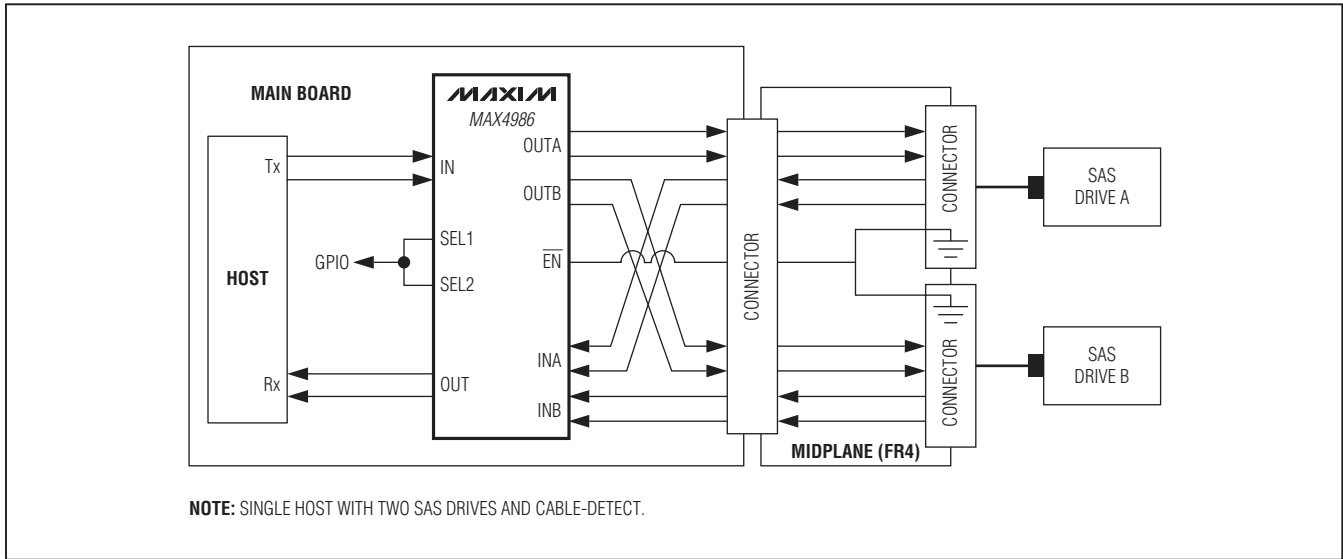
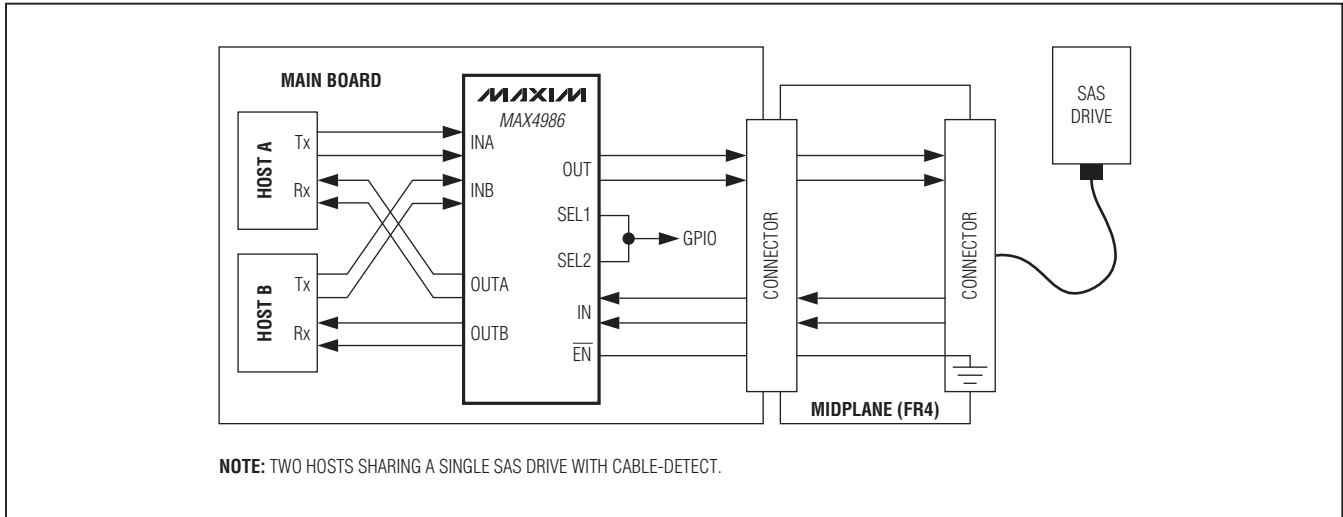

## Applications Information

### Layout

Circuit board layout and design can significantly affect the performance of the MAX4986. Use good, high-frequency design techniques, including minimizing ground inductance and using controlled impedance transmission lines on data signals. It is recommended to place 1 $\mu$ F and 0.01 $\mu$ F power-supply bypass capacitors in parallel as close to VCC as possible for each VCC pin. Always connect VCC to a power plane.

### Exposed-Pad Package

The exposed-pad, 42-pin TQFN package incorporates features that provide a very low-thermal resistance path for heat removal from the IC. The exposed pad on the MAX4986 must be soldered to the circuit board ground plane for proper thermal performance. For more information on exposed-pad packages, refer to Maxim Application Note 862: *HFAN-08.1: Thermal Considerations of QFN and Other Exposed-Paddle Packages*.

# SAS/SATA Single Lane 2:1/1:2 Multiplexer/ Demultiplexer Plus Redriver with Equalization

## Power-Supply Sequencing

**Caution:** Do not exceed the absolute maximum ratings because stresses beyond the listed ratings may cause permanent damage to the device.

Proper power-supply sequencing is recommended for all devices. Always apply GND then VCC before applying signals, especially if the signal is not current-limited.

## Chip Information

PROCESS: BiCMOS

## Package Information

For the latest package outline information and land patterns (footprints), go to [www.maxim-ic.com/packages](http://www.maxim-ic.com/packages). Note that a "+", "#", or "-" in the package code indicates RoHS status only. Package drawings may show a different suffix character, but the drawing pertains to the package regardless of RoHS status.

PACKAGE TYPE	PACKAGE CODE	OUTLINE NO.	LAND PATTERN NO.
42 TQFN-EP	T423590+1	<a href="#">21-0181</a>	<a href="#">90-0078</a>

MAX4986

# **SAS/SATA Single Lane 2:1/1:2 Multiplexer/ Demultiplexer Plus Redriver with Equalization**

## **Revision History**

<b>REVISION NUMBER</b>	<b>REVISION DATE</b>	<b>DESCRIPTION</b>	<b>PAGES CHANGED</b>
0	1/10	Initial release	—
1	7/12	Added MAX4986ETO+ to data sheet	1, 2, 3

*Maxim cannot assume responsibility for use of any circuitry other than circuitry entirely embodied in a Maxim product. No circuit patent licenses are implied. Maxim reserves the right to change the circuitry and specifications without notice at any time. The parametric values (min and max limits) shown in the Electrical Characteristics table are guaranteed. Other parametric values quoted in this data sheet are provided for guidance.*

**14** \_\_\_\_\_ **Maxim Integrated Products, Inc. 160 Rio Robles, San Jose, CA 95134 USA 1-408-601-1000**