

Fast Recovery Epitaxial Diode (FRED)

$$I_{FAV} = 109 \text{ A}$$

$$V_{RRM} = 1200 \text{ V}$$

$$t_{rr} = 40 \text{ ns}$$

Part number

DSEI 120-12A

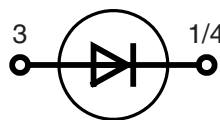
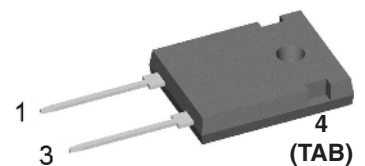
TO-247AD

Features / Advantages:

- Planar passivated chips
- Low leakage current
- Very short recovery time
- Improved thermal behaviour
- Extremely low switching losses
- Low I_{RM} -values
- Soft recovery behaviour
- High reliability circuit operation
- Low voltage peaks for reduced protection circuits
- Low noise switching
- Low losses
- Operating at lower temperature or space saving by reduced cooling

Applications:

- Antiparallel diode for high frequency switching devices
- Antisaturation diode
- Snubber diode
- Free wheeling diode in converters and motor control circuits
- Rectifiers in switch mode power supplies (SMPS)
- Inductive heating and melting
- Uninterruptible power supplies (UPS)
- Ultrasonic cleaners and welders

Package: TO-247AD

- Industry standard outline
- RoHS compliant
- Epoxy meets UL 94V-0

Disclaimer Notice

Information furnished is believed to be accurate and reliable. However, users should independently evaluate the suitability of and test each product selected for their own applications. Littelfuse products are not designed for, and may not be used in, all applications. Read complete Disclaimer Notice at www.littelfuse.com/disclaimer-electronics.

Symbol	Conditions	Maximum Ratings	
I_{FRMS}	$T_{VJ} = T_{VJM}$	100	A
I_{FAVM} ①	$T_C = 60^\circ\text{C}$; rectangular, $d = 0.5$	109	A
I_{FAV} ②	$T_C = 95^\circ\text{C}$; rectangular, $d = 0.5$	75	A
I_{FRM}	$t_p < 10$ s; rep. rating, pulse width limited by T_{VJM}	1200	A
I_{FSM}	$T_{VJ} = 45^\circ\text{C}$; $t = 10$ ms (50 Hz), sine	600	A
	$t = 8.3$ ms (60 Hz), sine	660	A
	$T_{VJ} = 150^\circ\text{C}$; $t = 10$ ms (50 Hz), sine	540	A
	$t = 8.3$ ms (60 Hz), sine	600	A
I^2t	$T_{VJ} = 45^\circ\text{C}$; $t = 10$ ms (50 Hz), sine	1800	A ² s
	$t = 8.3$ ms (60 Hz), sine	1800	A ² s
	$T_{VJ} = 150^\circ\text{C}$; $t = 10$ ms (50 Hz), sine	1450	A ² s
	$t = 8.3$ ms (60 Hz), sine	1500	A ² s
P_{tot}	$T_C = 25^\circ\text{C}$	357	W

Symbol	Conditions	Characteristic Values		
		typ.	max.	
I_R	$V_R = V_{RRM}$ $T_{VJ} = 25^\circ\text{C}$		3	mA
	$V_R = 0.8 \cdot V_{RRM}$ $T_{VJ} = 25^\circ\text{C}$		1.5	mA
	$V_R = 0.8 \cdot V_{RRM}$ $T_{VJ} = 125^\circ\text{C}$		20	mA
V_F	$I_F = 70$ A $T_{VJ} = 150^\circ\text{C}$		1.55	V
	$T_{VJ} = 25^\circ\text{C}$		1.80	V
V_{T0}	For power-loss calculations only		1.2	V
r_T	$T_{VJ} = T_{VJM}$		4.6	mΩ
R_{thJC}		0.25	0.35	K/W
R_{thCH}			K/W	
R_{thJA}			35	K/W
t_{rr}	$I_F = 1$ A; $-di/dt = 200$ A/μs; $V_R = 30$ V; $T_{VJ} = 25^\circ\text{C}$	40	60	ns
I_{RM}	$V_R = 350$ V; $I_F = 75$ A; $-di_F/dt = 200$ A/μs	25	30	A
	$L \leq 0.05$ μH; $T_{VJ} = 100^\circ\text{C}$			

① Chip capability; ② limited to 70 A by leads

Data according to IEC 60747

Outline Drawing TO-247AD

Dimensions in mm (1 mm = 0.0394")

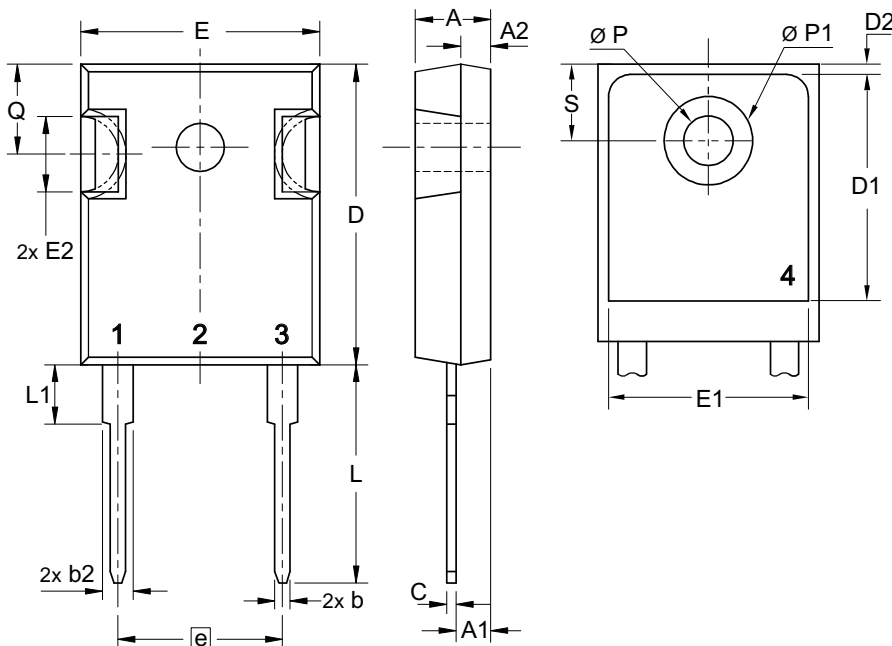

Sym.	Inches		Millimeter	
	min.	max.	min.	max.
A	0.185	0.209	4.70	5.30
A1	0.087	0.102	2.21	2.59
A2	0.059	0.098	1.50	2.49
D	0.819	0.845	20.79	21.45
E	0.610	0.640	15.48	16.24
E2	0.170	0.216	4.31	5.48
e	0.430 BSC		10.92 BSC	
L	0.780	0.800	19.80	20.30
L1	-	0.177	-	4.49
Ø P	0.140	0.144	3.55	3.65
Q	0.212	0.244	5.38	6.19
S	0.242 BSC		6.14 BSC	
b	0.039	0.055	0.99	1.40
b2	0.065	0.094	1.65	2.39
b4	0.102	0.135	2.59	3.43
c	0.015	0.035	0.38	0.89
D1	0.515	-	13.07	-
D2	0.020	0.053	0.51	1.35
E1	0.530	-	13.45	-
Ø P1	-	0.29	-	7.39

IXYS reserves the right to change limits, test conditions and dimensions.

20220615b



Package TO-247AD			Ratings			
Symbol	Definitions	Conditions	min.	typ.	max.	
T _{vj}	virtual junction temperature		-40		150	°C
T _{stg}	storage temperature		-40		150	°C
Weight				6		g
M _D	mounting torque		0.8		1.2	Nm

Product Marking

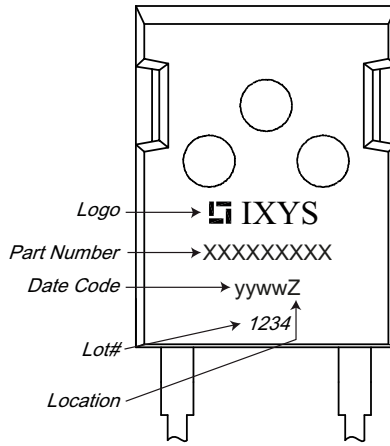

Ordering	Part Number	Marking on Product	Delivering Mode	Base Qty	Ordering Code
Standard	DSEI120-12A	DSEI120-12A	Tube	30	467731

Curves

 Fig. 1 Forward current I_F vs. V_F

 Fig. 2 Reverse recovery charge Q_r versus $-di_F/dt$

 Fig. 3 Peak reverse current I_{RM} versus $-di_F/dt$

 Fig. 4 Dynamic parameters Q_r , I_{RM} versus T_{VJ}

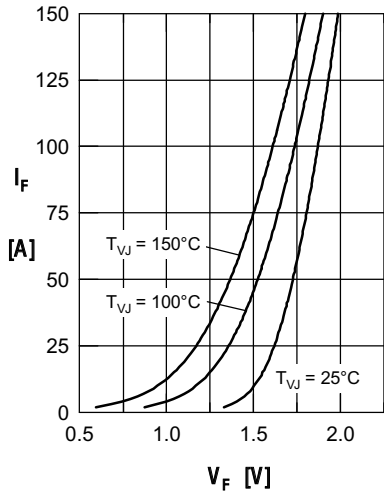
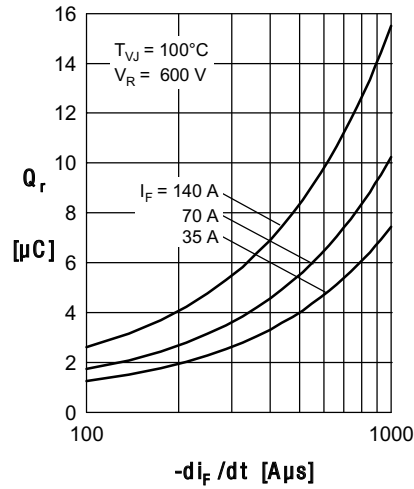
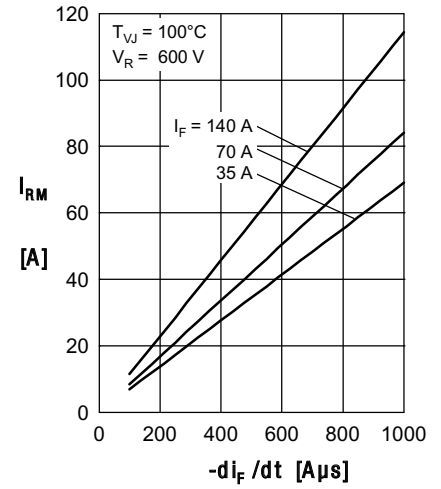
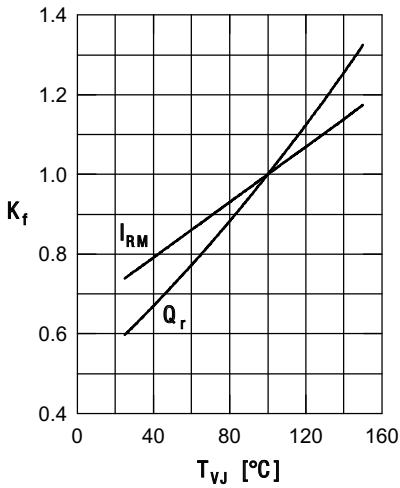
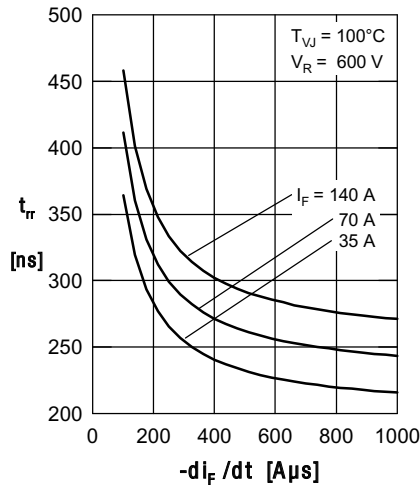
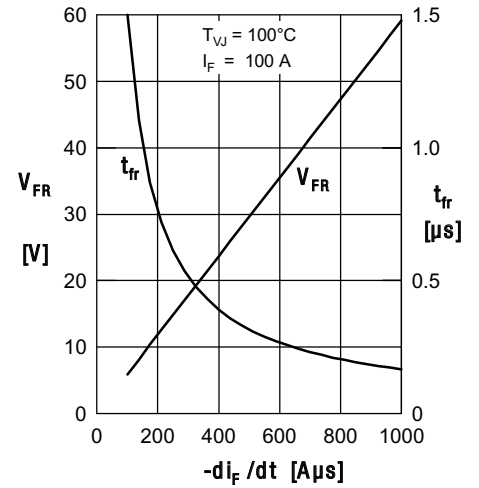
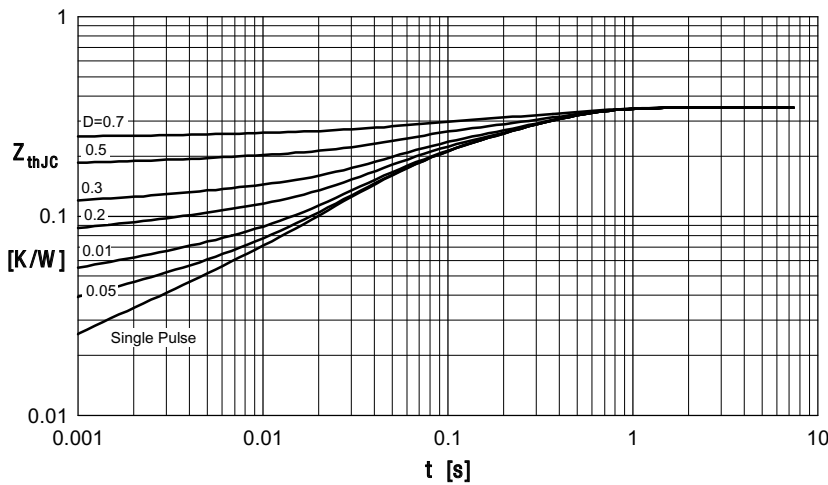
 Fig. 5 Recovery time t_{tr} versus $-di_F/dt$

 Fig. 6 Peak forward voltage V_{FR} and t_{tr} versus $-di_F/dt$

Fig. 7 Transient thermal resistance junction to case at various duty cycles

IXYS reserves the right to change limits, test conditions and dimensions.

 Constants for Z_{thJC} calculation:

i	R_{thi} (K/W)	t_i (s)
1	0.017	0.00038
2	0.0184	0.0026
3	0.1296	0.0387
4	0.185	0.274