

Type 2JS / 3JS

Time-lag Fuse Series

HF  2JS/3JS Series, 5x15mm Glass Tube Time-lag Fuse

RoHS Compliant

Description

5x15mm Time-lag, glass tube body cartridge fuse designed, approved and complied with UL and CSA standard 248-14.



Features

- Meet UL and CSA standard 248-14
- Wide operating temperature range
- Bulk and Tape & Reel packing available
- Full compliance with EU Directive 2011/65/EU and amending directive 2015/863
- Halogen Free
- Lead Free

Applications



Provide individual protection for components or internal circuits.

- Power supplies
- Battery charger
- Monitor
- Adapter

LEAD FREE = 
HALOGEN FREE = 





Physical Specifications

Materials	Body : Glass
	Cap : Nickel Plated Brass Caps
	Leads : Matte Tin Plated Copper
Marking	On Fuse :
	"bel", "JS", "Current Rating", " Voltage Rating",
	"Appropriate Safety Logos", " ✓ " (RoHS compliant)
	On Label :
	"bel", "2JS"or"3JS", "Current Rating", "Voltage Rating", "Interrupting Rating",
	"Appropriate Safety Logos" and "  ", "  "(China RoHS compliant).

Electrical Characteristics (UL/CSA STD.248-14) Safety Agency Approvals



Testing Current	Blow Time	
	Minimum	Maximum
100%	4 hrs.	N/A
135%	N/A	1 hr.
200%	3 sec	20 sec
500%	100 msec	1.5 sec
1000%	30 msec	300 msec

Safety Agency	Safety Agency Certificate	Ampere Rating/ Voltage Rating	Ampere Range / Volt @ I.R. ability*
	E20624	500mA-7A /350V AC	500mA-7A/350V AC@100A 500mA-7A/125V AC@10.000A 500mA-7A/140V DC@150A
	LR39772		500mA-7A/350V AC@100A 500mA-7A/125V AC@10.000A
	JET1037-31003-1010 JET1037-31003-1011 JET1037-31003-1007		1A-5A/125V AC@500A >5A-15A/125V AC@300A
*I.R.= Interrupting Rating = Short Circuit Rating(Amps)			

Environmental Specifications

Shock Resistance	MIL-STD-202G, Method 213B, Test Condition 1 (100 G's peak for 6 milliseconds; Sawtooth waveform)
Vibration Resistance	MIL-STD-202G, Method 201A (10-55 Hz, 0.06 inch, total excursion).
Salt Spray Resistance	MIL-STD-202G, Method 101E, Test Condition B (48 hrs).
Insulation Resistance	MIL-STD-202G, Method 302, Test Condition A (After Opening) 10,000 ohms minimum.
Solderability	MIL-STD-202G, Method 208H
Resistance to solder Heat	MIL-STD-202G, Method 210F, Test Condition B (260+/-5°C, 10+/-1 sec)
Thermal Shock	MIL-STD-202G, Method 107G, Test Condition B (-65°C to +125°C).
Operating Temperature	-55°C to +125°C
Terminal Strength	IEC-68-2-21

Electrical Specifications

Catalog Number	Ampere Rating	Typical Cold Resistance (ohms)	Volt-drop @100%In (Volt) max.	Voltage and Interrupting Ratings	Melting I²T <10 mSec (A² Sec)	Melting I²T @10 In (A² Sec)	Maximum Power Dissipation (W)	Agency Approvals		
										
JS 500-R	500mA	0.62	0.53	See Table of Safety Approvals on Page 1 for Voltage and associated Interrupting Ratings	1.6	2.0	0.47	Y	Y	
JS 600-R	600mA	0.44	0.53		2.2	2.3	0.49	Y	Y	
JS 700-R	700mA	0.32	0.42		3.0	4.0	0.54	Y	Y	
JS 750-R	750mA	0.28	0.38		3.0	4.0	0.55	Y	Y	
JS 800-R	800mA	0.23	0.37		5.0	7.0	0.60	Y	Y	
JS 1-R	1A	0.19	0.36		5.9	7.8	0.64	Y	Y	Y
JS 1.25-R	1.25A	0.13	0.30		9.3	12	0.71	Y	Y	Y
JS 1.5-R	1.5A	0.094	0.23		15	19	0.80	Y	Y	Y
JS 2-R	2A	0.063	0.22		23	30	0.89	Y	Y	Y
JS 2.5-R	2.5A	0.046	0.21		35	46	0.99	Y	Y	Y
JS 3-R	3A	0.037	0.19		55	72	1.10	Y	Y	Y
JS 3.5-R	3.5A	0.030	0.18		69	91	1.16	Y	Y	Y
JS 4-R	4A	0.026	0.18		86	114	1.22	Y	Y	Y
JS 5-R	5A	0.018	0.16		135	179	1.36	Y	Y	Y
JS 6-R	6A	0.015	0.16		211	279	1.51	Y	Y	Y
JS 7-R	7A	0.012	0.15		263	350	1.60	Y	Y	Y

Consult manufacturer for other ratings



Specifications subject to change without notice

Bel Fuse Inc.
206 Van Vorst Street
Jersey City, NJ 07302 USA

+1 201.432.0463
Bel.US.CS@belf.com
belfuse.com/circuit-protection

Temperature Derating Curve

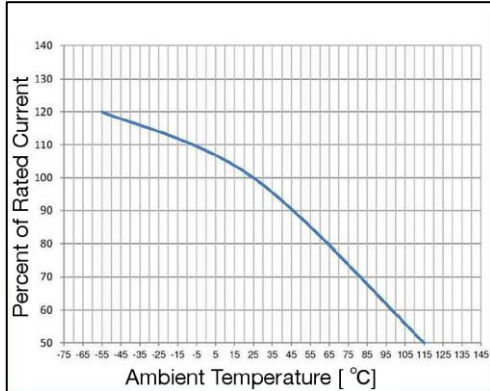

Average Time Current Curve

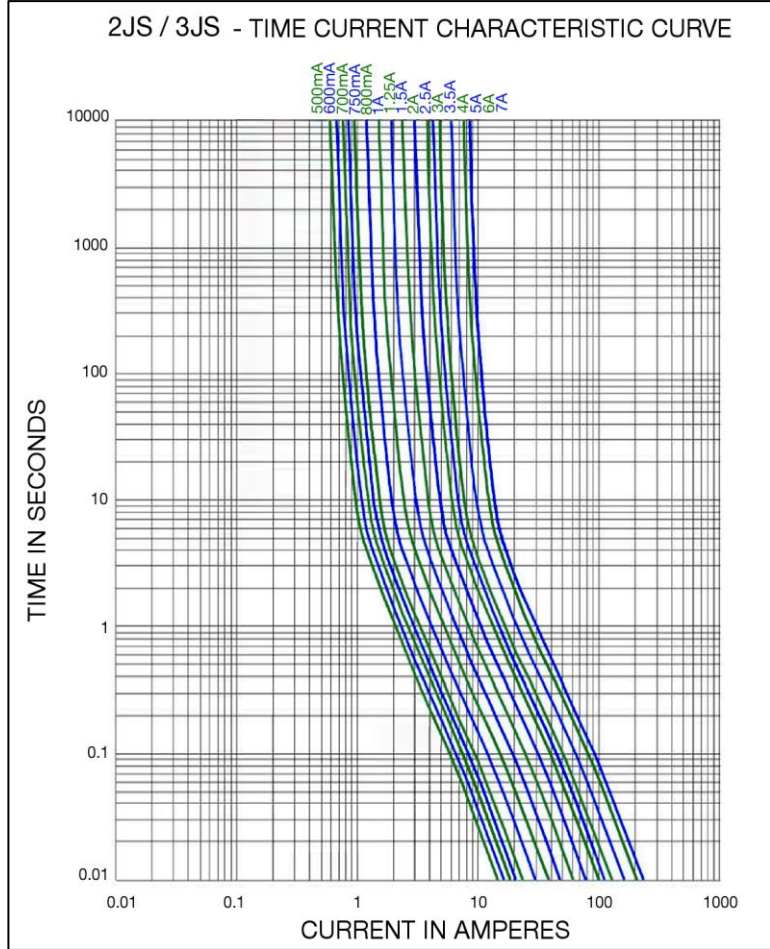

Soldering Parameters

Lead-free Wave Soldering Profile	
Wave Soldering Parameter	
Average ramp-up rate	200°C / second
Heating rate during preheat	typical 1 - 2°C / second Max 4°C / second
Final preheat temperature	within 125°C of soldering temperature
Peak temperature T _p	260°C
Time within +0°C / -5°C of actual peak temperature	10 seconds
Ramp-down rate	5°C / second max.

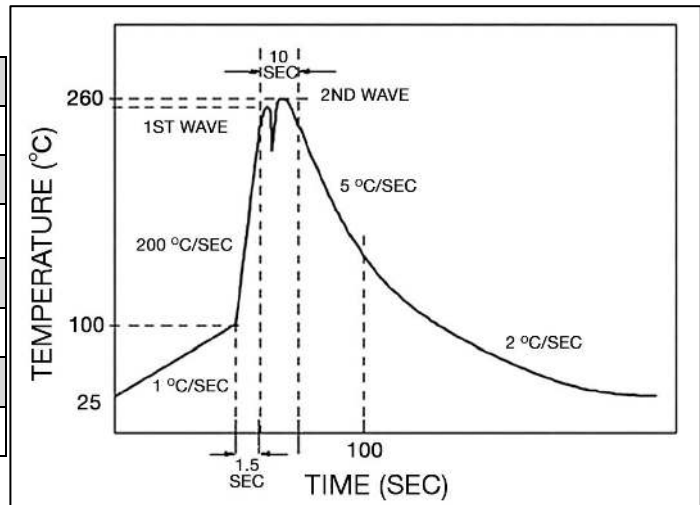

Fuse FGNO Explanation

0658 R [XXXX] -XX

0658R=2JS/3JS; [XXXX]=Ampere Rating; XX=See Ordering Information as below

Fraction	Decimal	Milliamps	Bel FGNO[XXXX]
1/2	.500	500	0500
6/10	.600	600	0600
7/10	.700	700	0700
3/4	.750	750	0750
8/10	.800	800	0800

Fraction	Decimal	Amps	Bel FGNO[XXXX]
	1.0	1	1000
1-1/4	1.25	1.25	1250
1-1/2	1.50	1.5	1500
	2.0	2	2000
2-1/2	2.5	2.5	2500
	3.0	3	3000
3-1/2	3.5	3.5	3500
	4.0	4	4000
	5.0	5	5000
	6.0	6	6000
	7.0	7	7000

Mechanical Dimensions

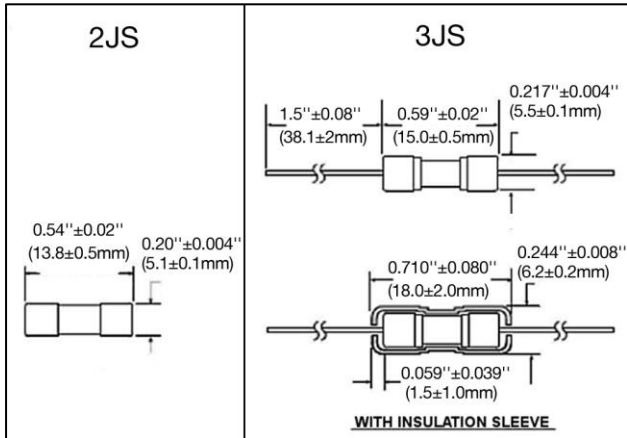

Ordering Information

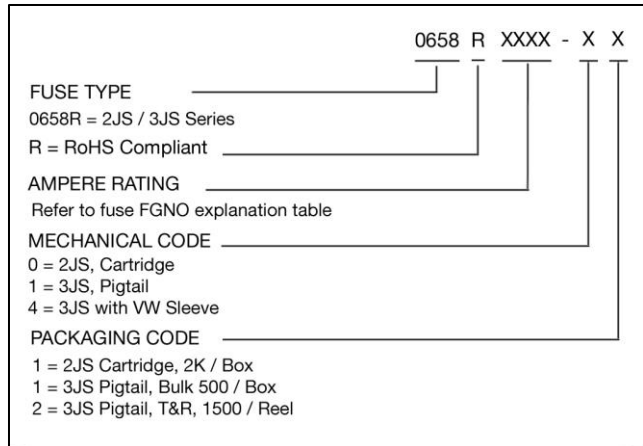

*Diameter lead 0.032 ± 0.002 " for all ratings

Packaging

Packaging Option	Packaging Specification	Quantity	Packaging Code	Inside Tape Spacing
Bulk (bag)	N/A	2000	01	N/A
Bulk (Pigtail Type)	N/A	500	11	N/A
Bulk (Pigtail Type) with Insulation Sleeve	N/A	500	41	N/A
Tape & Reel	EIA-296-F	1500	12	10mm Pitch and 53mm
Tape & Reel with Insulation Sleeve	EIA-296-F	1500	42	10mm Pitch and 53mm



Specifications subject to change without notice

Bel Fuse Inc.
206 Van Vorst Street
Jersey City, NJ 07302 USA

+1 201.432.0463
Bel.US.CS@belf.com
belfuse.com/circuit-protection