



TAOGLAS®



Datasheet

AP.10G GPS/Galileo 1 Stage SMD Active Patch 11.5*10*10mm

Part No:
AP.10G.01

Description:

10mm SMD 14dB Active GPS/Galileo Patch Antenna With Front End Saw Filter

Features:

- Unique SMD GPS/Galileo active patch
- Wide Input Voltage 1.5V to 3.3V
- Ultra low power consumption
- RoHS & Reach Compliant

1. Introduction	3
2. Specifications	4
3. Passive Antenna Characteristics	6
4. Active Antenna Characteristics	9
5. Radiation Patterns	12
6. Mechanical Drawing	14
7. PCB Footprint	15
8. Recommended Reflow Soldering Profile	16
9. Packaging	17
<hr/>	
Changelog	18

Taoglas makes no warranties based on the accuracy or completeness of the contents of this document and reserves the right to make changes to specifications and product descriptions at any time without notice. Taoglas reserves all rights to this document and the information contained herein. Reproduction, use or disclosure to third parties without express permission is strictly prohibited.



1. Introduction



The AP.10G.01 one stage 14dB active GPS/Galileo patch antenna is the smallest SMD GPS/Galileo high performance embedded antenna currently available in the world. Using extremely sensitive high dielectric constant powder formulation and tight process control the 10mm x 10mm x 4mm patch antenna is accurately tuned to have its frequency band right at 1575.42MHz for GPS/Galileo systems.

A patented SMD structure gives high reliability in integration. With an ultra low power consumption one stage LNA with Saw Filter, this small active patch has the performance of an ordinary active patch, but at only a quarter of the size.

Typical Applications Include:

- Medical Devices
- Navigation
- Sports Tracking

The AP.10G has been designed to be directly mounted onto a PCB board via SMD process. With this in mind the AP.10G is supplied on a tape and reel and is compatible with pick and place machines used in the electronic component industry. For integration instructions or concerns, please contact your regional Taoglas customer support team.

2. Specifications

GNSS Frequency Bands Covered							
GPS/QZSS	L1 1575.42MHz	L2 1227.6MHz	L5 1176.45MHz	L6 1278.75MHz			
	■	□	□	□			
GLONASS	L5R 1176.45MHz	L3PT 1201.5MHz	L2PT 1246MHz	L1CR 1575.42MHz	L1PT 1602MHz		
	□	□	□	■	□		
Galileo	E5a 1176.45MHz	E5b 1201.5MHz	E4 1215MHz	E3 1256MHz	E6 1278.75MHz	E2 1561MHz	L1 1575.42MHz
	□	□	□	□	□	□	■
BeiDou	B1 1561MHz	B2 1207.14MHz	B3 1268.52MHz				
	□	□	□				
Compass	E5B(B2)/ E6(B3) 1268.56MHz	E2(B1) 1561MHz					
	□	□					
SBAS	Omnistar 1542.5MHz	WAAS/EGN OS 1575.42MHz					
	□	■					

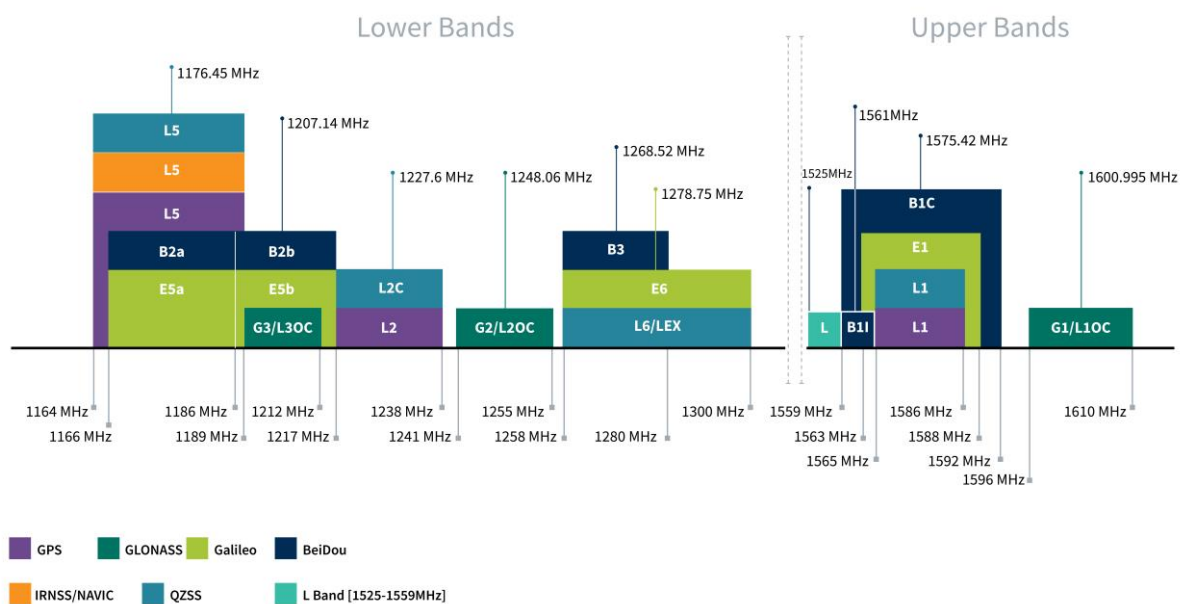

GNSS Electrical	
Frequency (MHz)	1575.42 ± 1.023MHz
VSWR (max.)	2.0:1
Gain (Patch)	Typ -10dBic @ Zenith
Gain (Patch and LNA)	8 ± 4dBic @ 90°
Axial Ratio (dB)	Max 4.0dB @ Zenith
Polarization	RHCP
Impedance	50Ω
Connector	SMD via solder pads

LNA and Filter Electrical Properties	
Frequency (MHz)	1575.42 ± 1.023MHz
Gain 1.5V - 3.3V	18dB
Noise 1.5V - 3.3V	2.6dB
Power consumption 1.5V - 3.3V	3.5mA
Outer Band Attenuation	F0=1575.42MHz
	F0±30MHz 9dB min.
	F0±50MHz 14dB min.
	F0±100MHz 16dB min.
Pout at 1dB Gain Compression point	Typ. 1dBm

Mechanical	
Planner Dimension	10mm x 10mm x 4mm (add 7.3mm depth for vertical PCB)
Connection	SMD via solder pads
Weight	10g

Enviromental	
Operation Temperature	-20°C to + 85°C
Storage Temperature	-30°C to + 85°C
Relative Humidity	40% to 95%
Moisture Senseitivity Level (MSL)	3 (168Hours)

3. Passive Antenna Characteristics

3.1 Return Loss

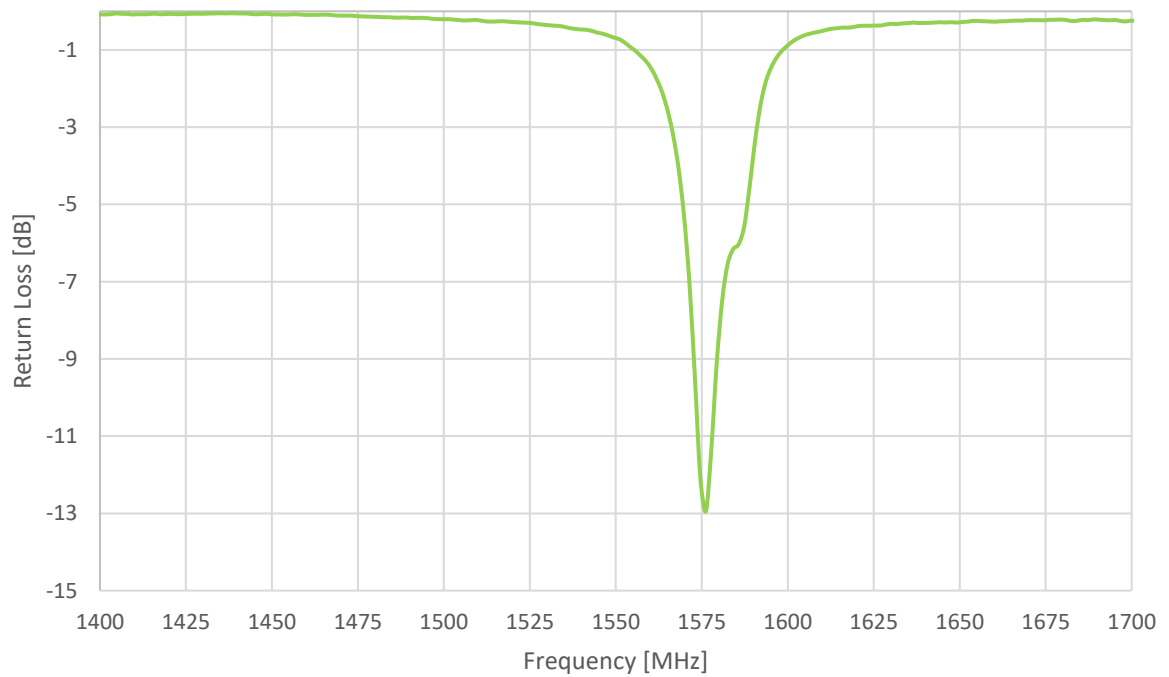

3.2 Efficiency

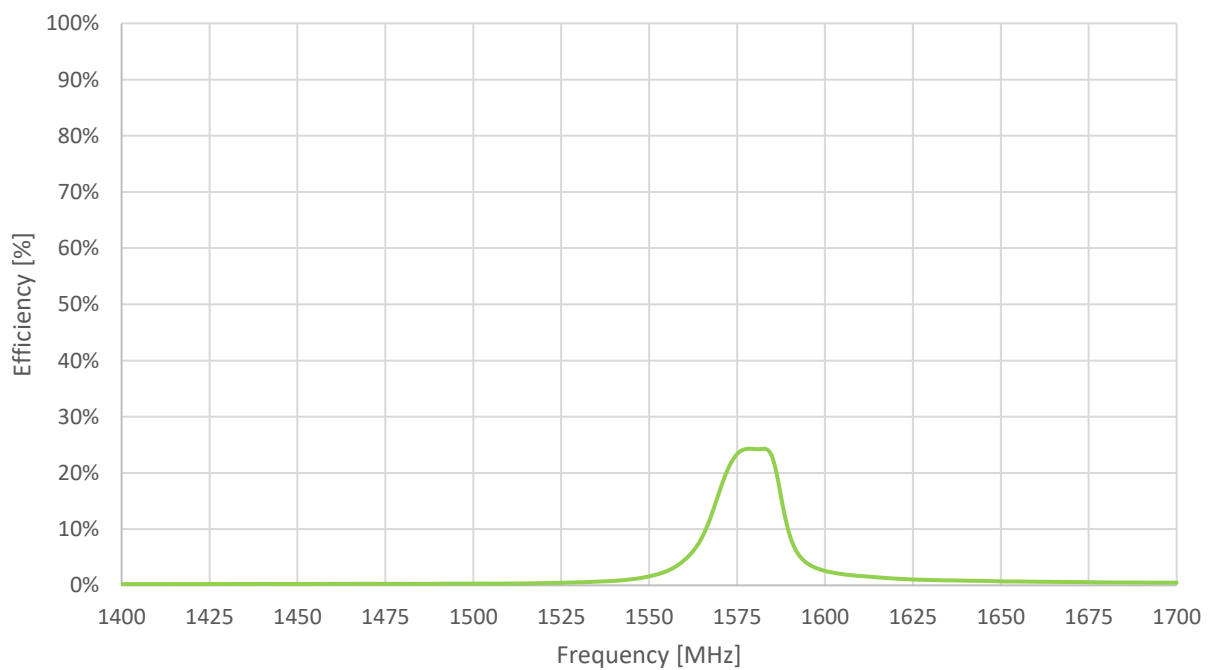

3.3 Average Gain

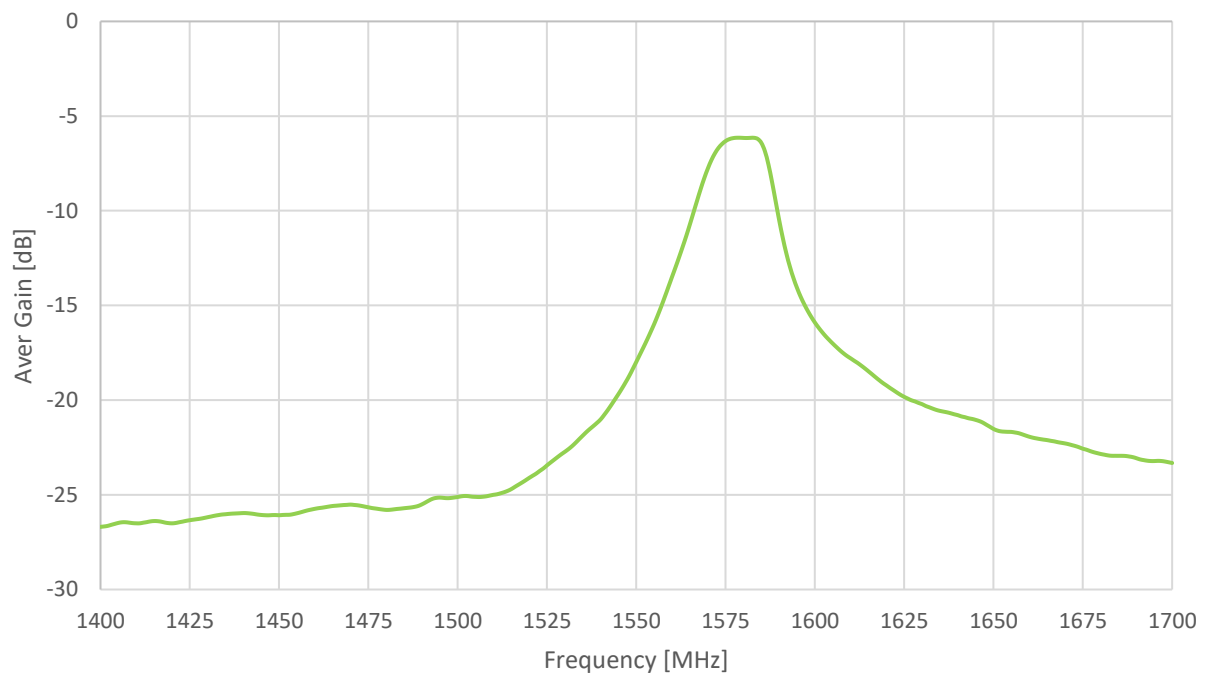

3.4 Peak Gain

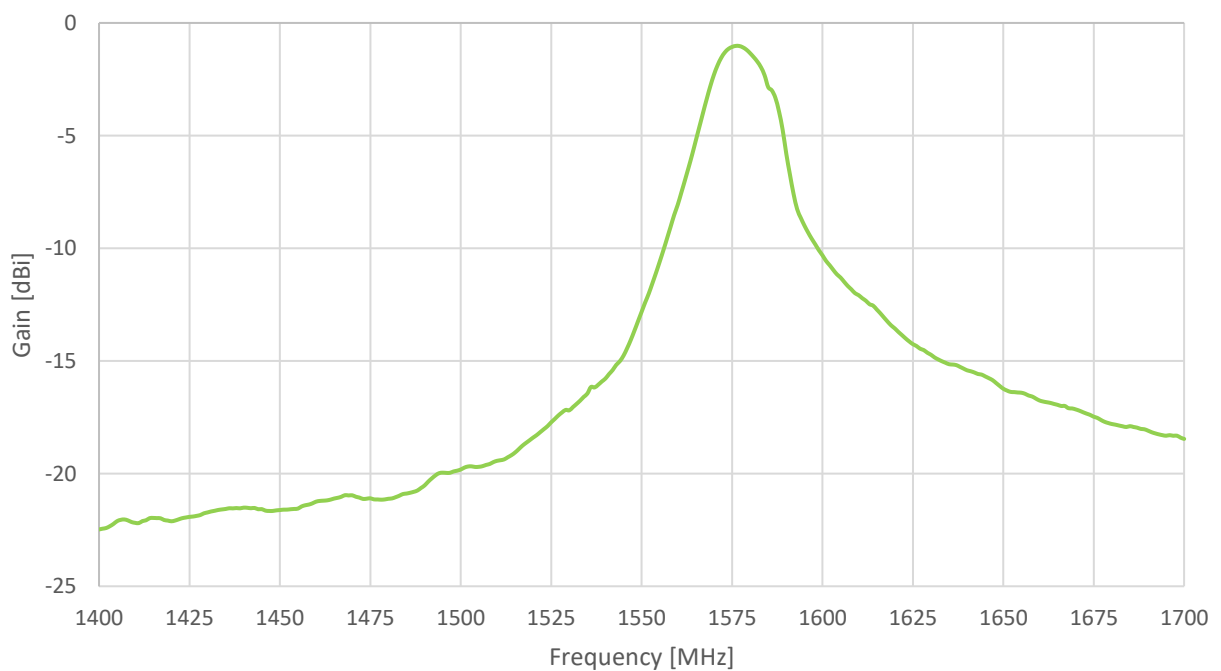

3.5 Axial Ratio vs Frequency

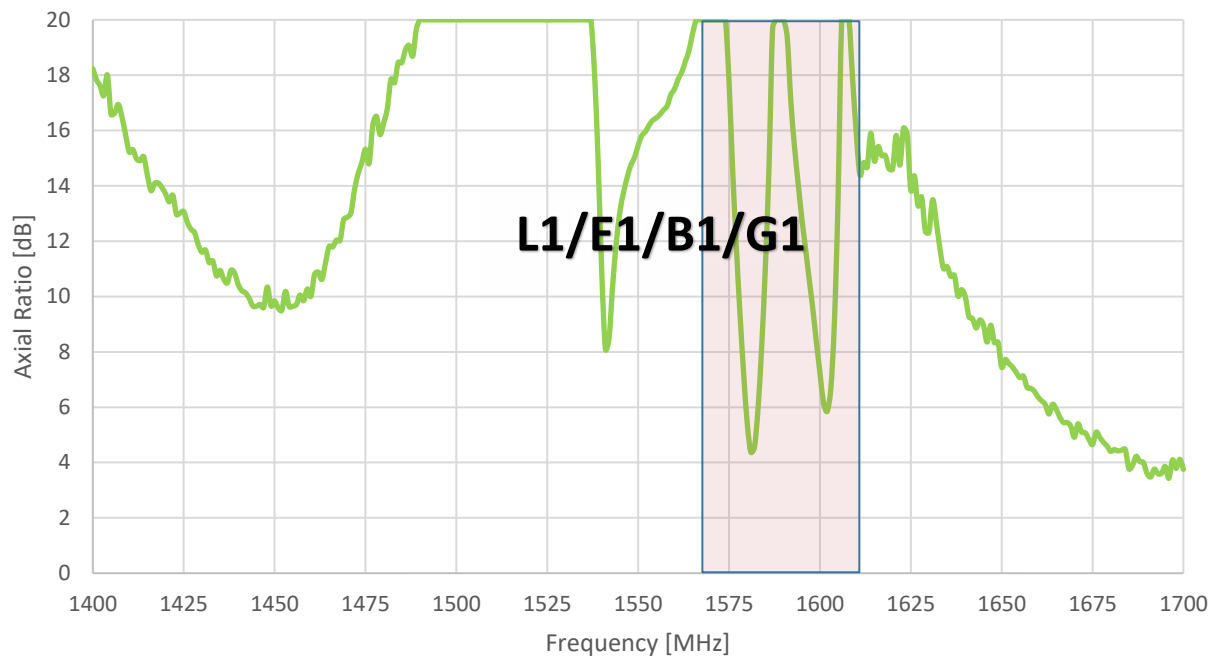

4. Active Antenna Characteristics

4.1 Group Delay

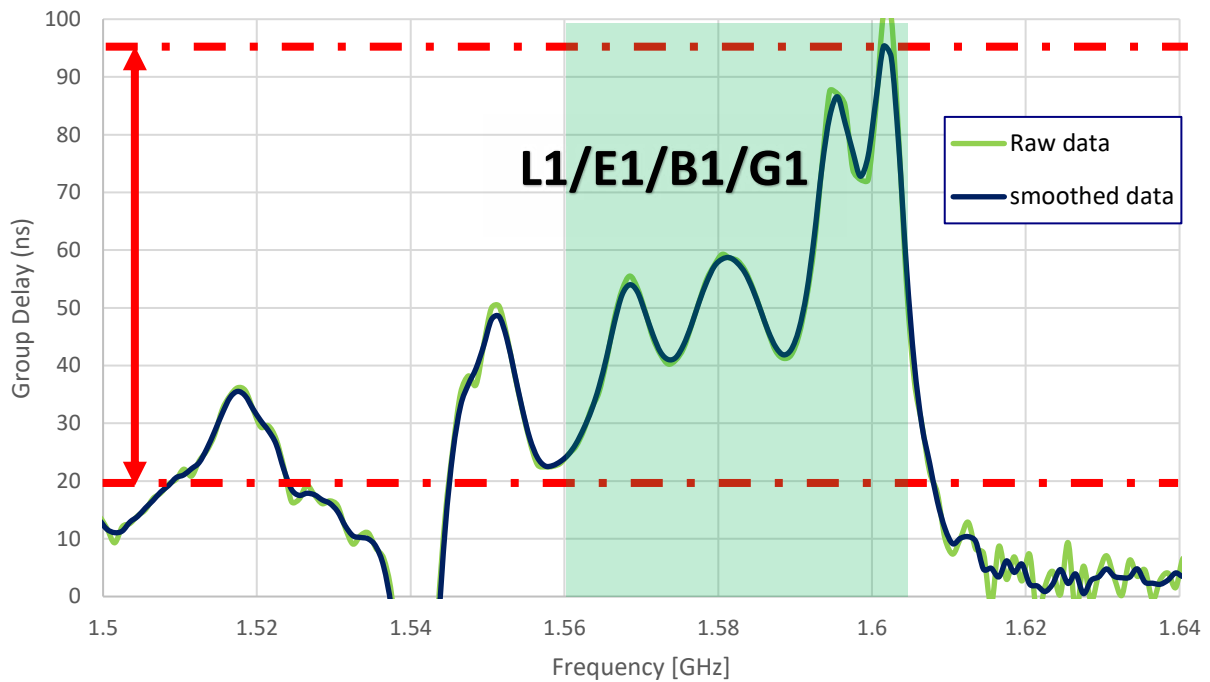

4.2 Phase Centre Variation

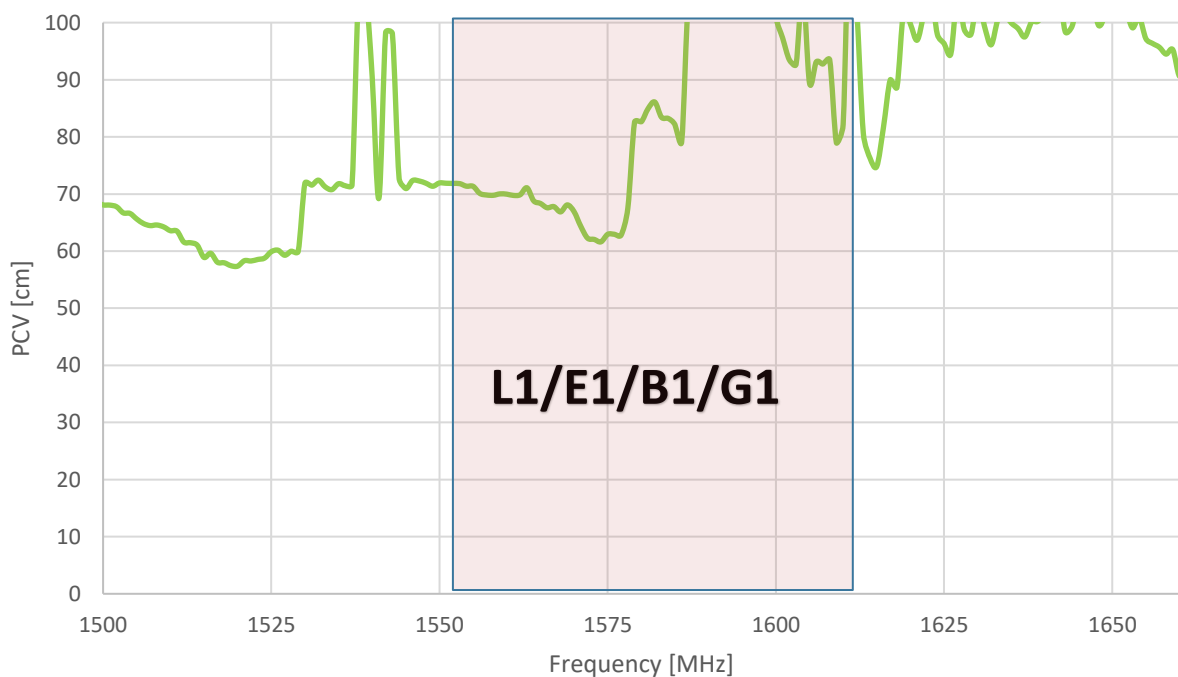

4.3 Phase Centre Offset

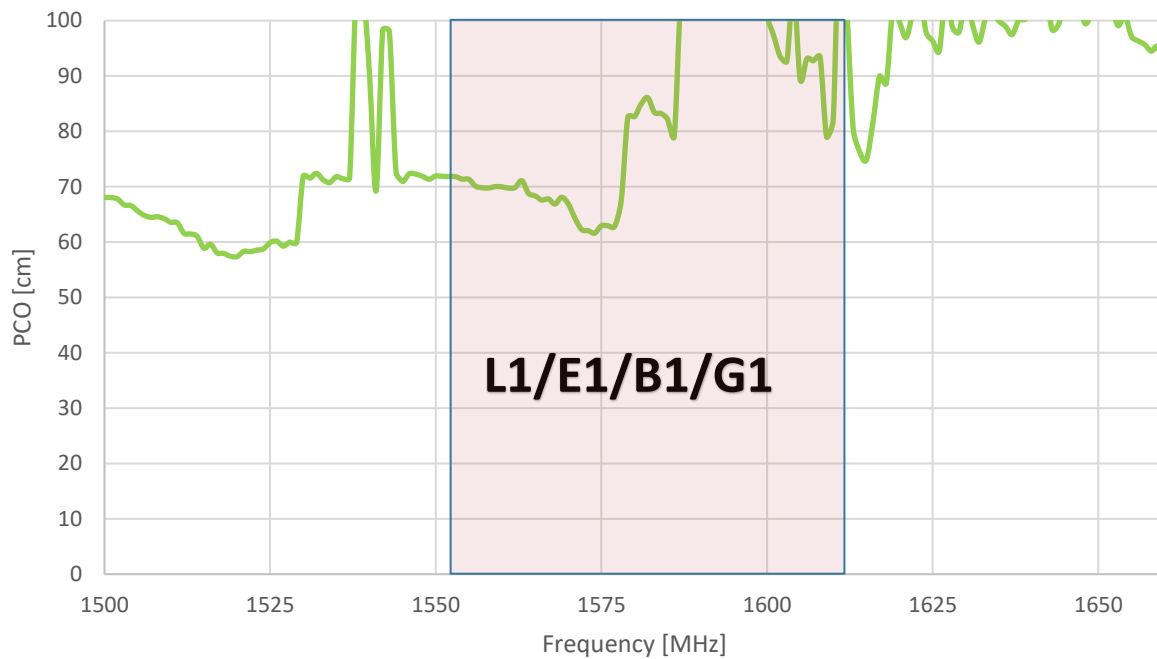

4.4 LNA Gain and Out Band Rejection @3.0V

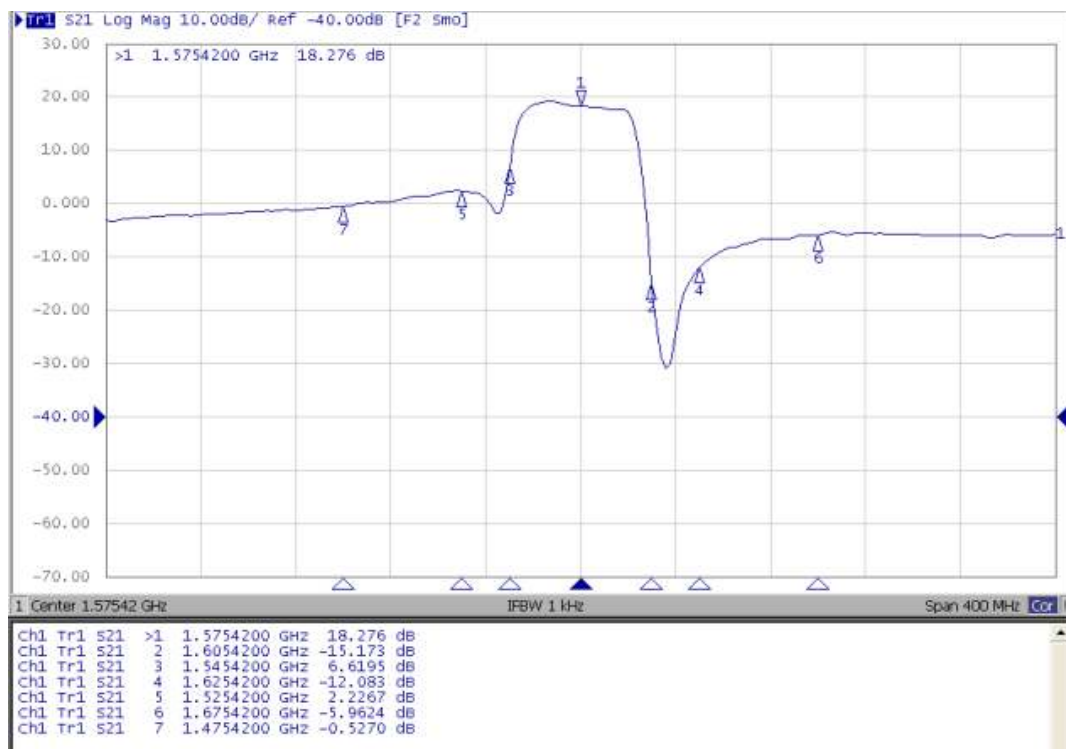

4.5 LNA Noise Figure @3.0V

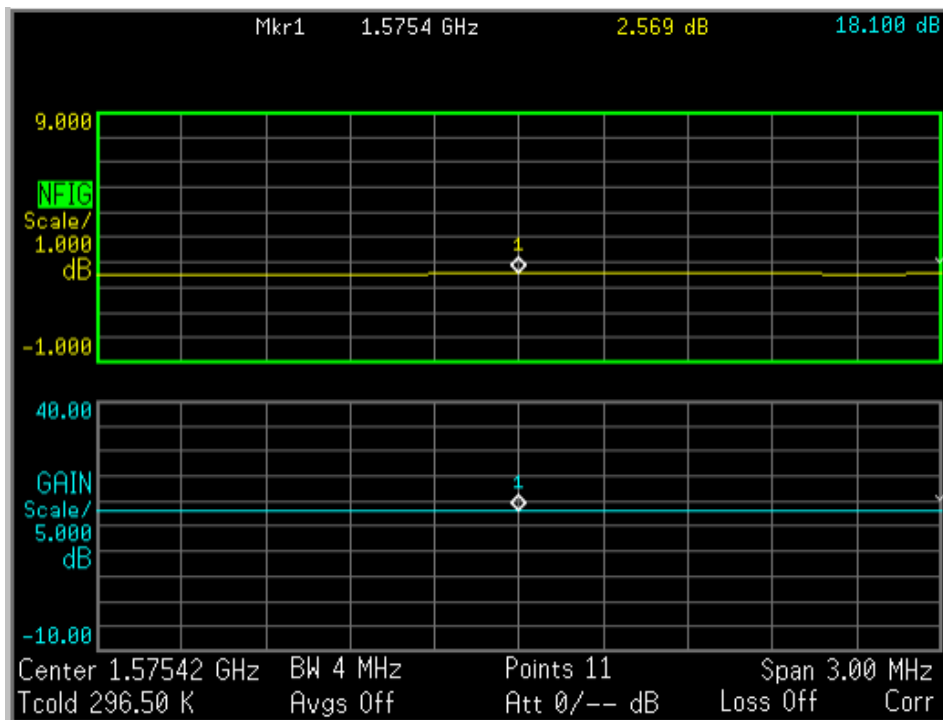

5. Radiation Patterns

5.1 Test Setup

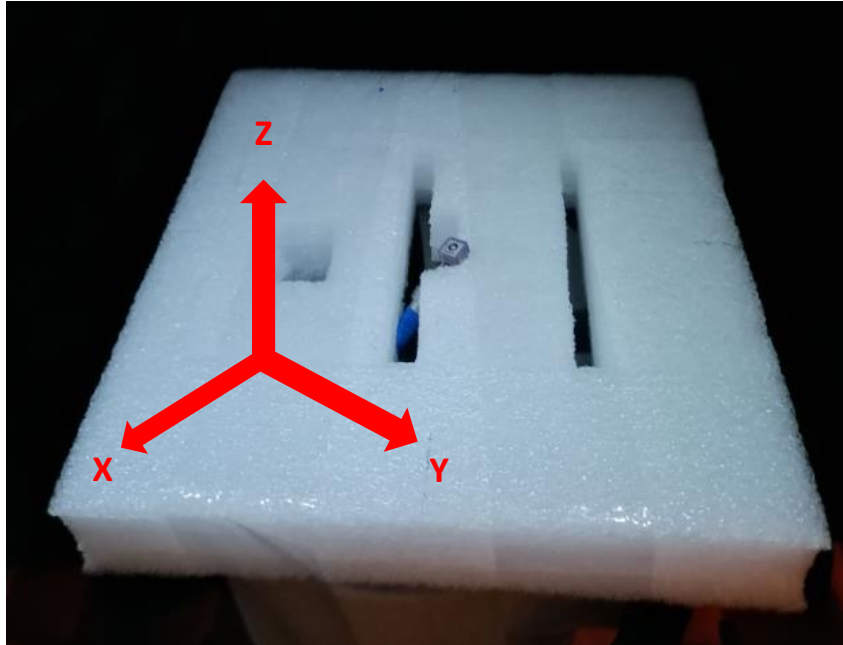

5.2 1575MHz 3D and 2D Radiation Patterns

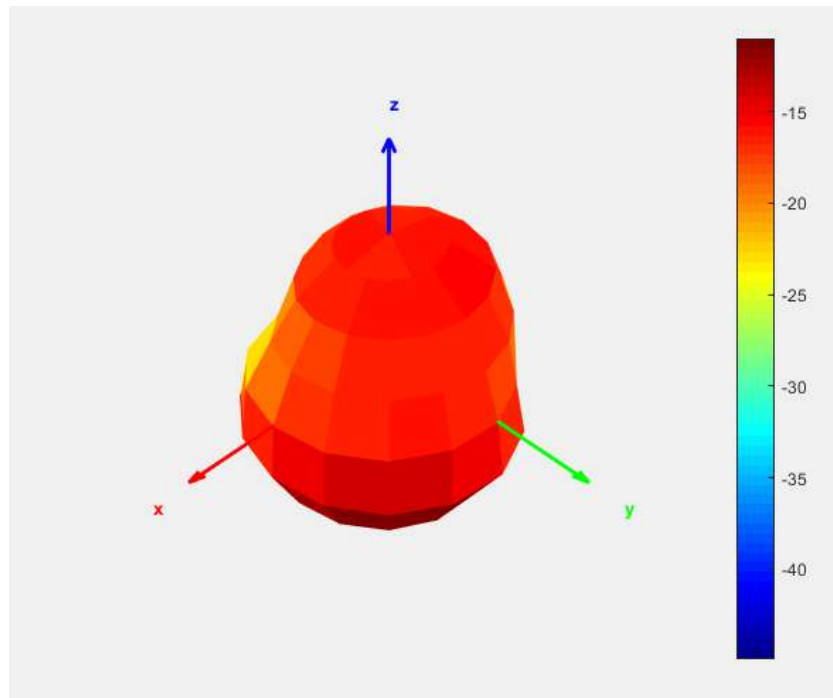

XY Plane

XZ Plane

YZ Plane

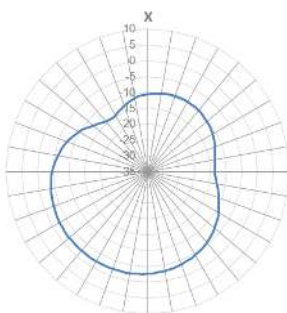

1575 MHz

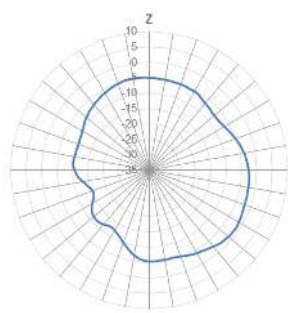

1575 MHz

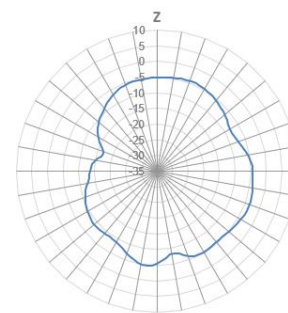

1575 MHz

6. Mechanical Drawing (Units: mm)

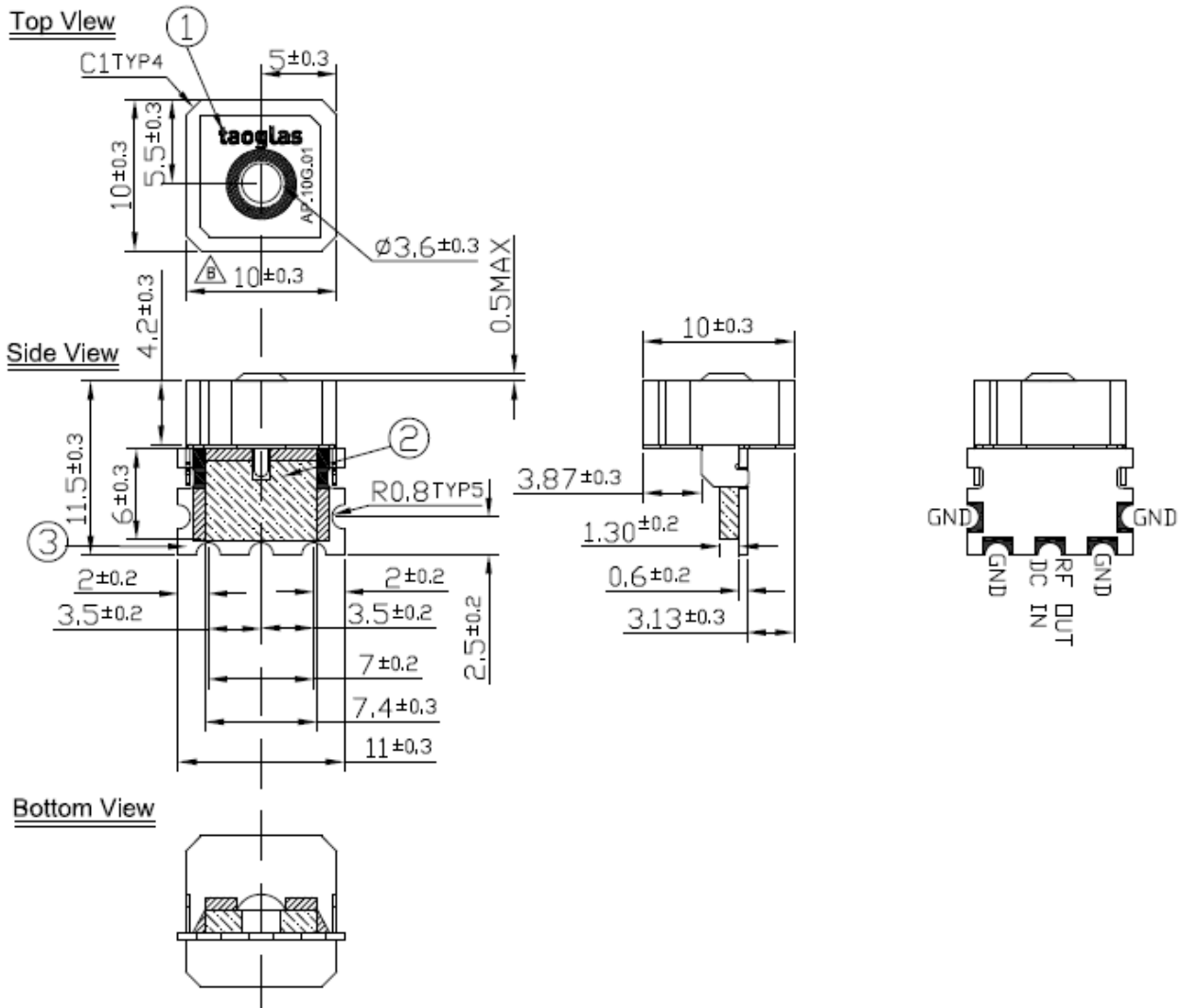

7. PCB Footprint

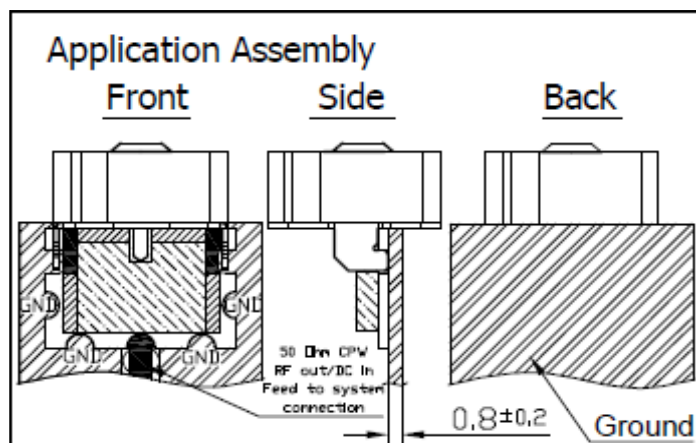
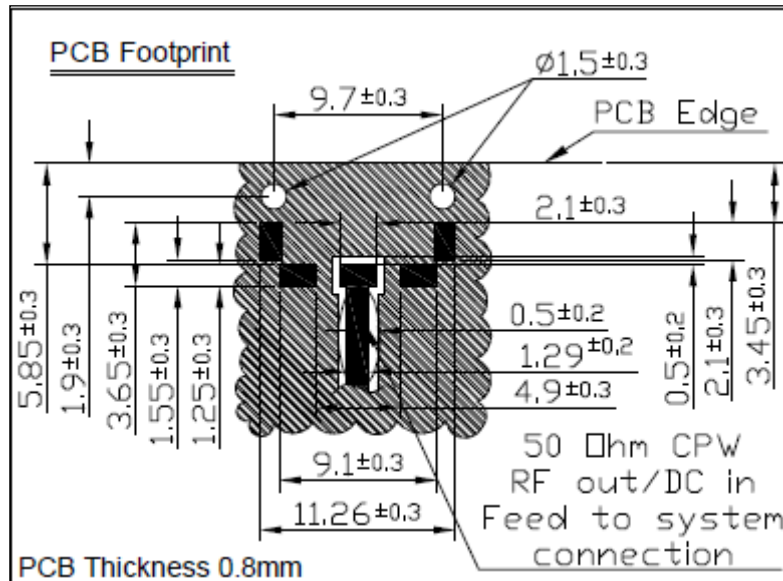

Note:

1. Soldered Area
2. Solder Mask Area (Green)
3. Clearance Area
4. Shielding Case Area
5. Area to be solder (Pad)



8. Recommended Reflow Soldering Profile

The graphic shows temperature profile for component assembly process in reflow ovens

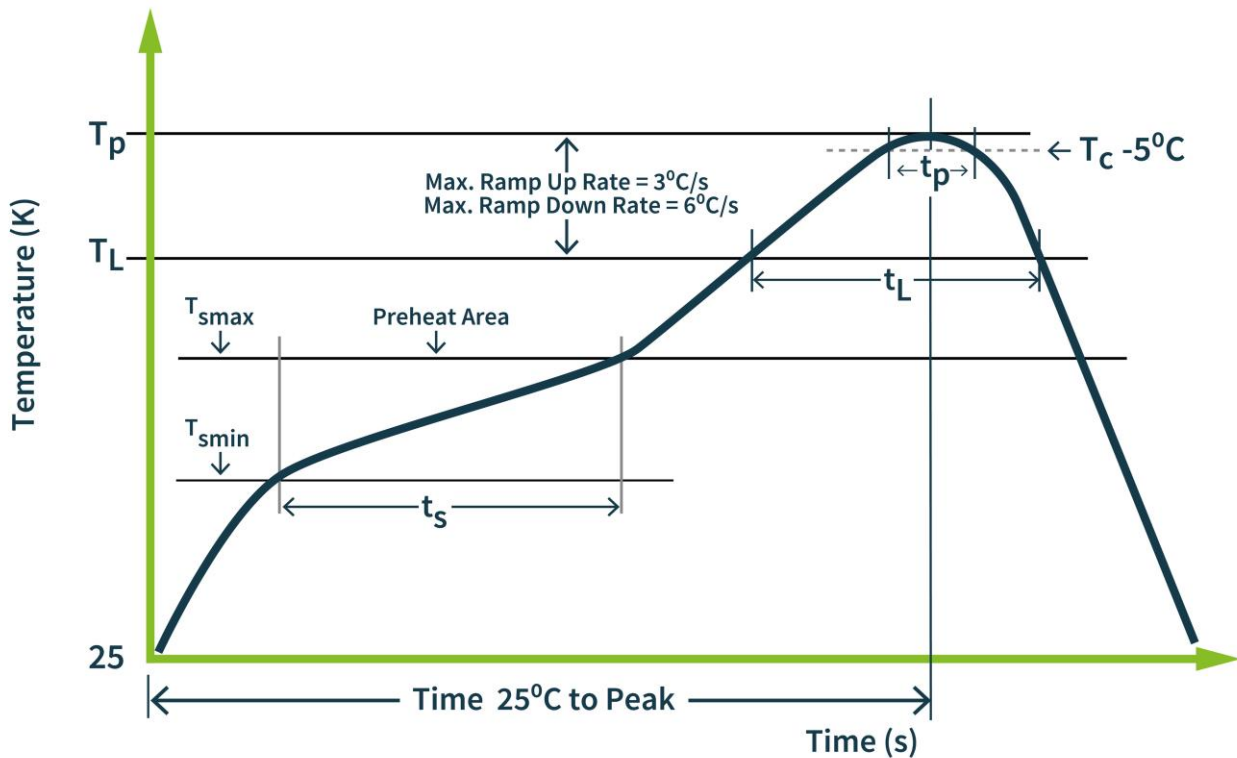

Phase	Profile Features	Pb-Free Assembly (SnAgCu)
Preheat	Temperature Min(Tsmin) Temperature Max(Tsmax) Time(ts) from (Tsmin to Tsmax)	150°C 200°C 60-120 seconds
Ramp-up	Avg. Ramp-up Rate (Tsmax to TP)	3°C/second(max)
Reflow	Temperature(TL) Total Time above TL (tL)	217°C 30-100 seconds
Peak	Temperature(TP) Time(tp)	260°C 2-5 seconds
Time from 25°C to Peak Temperature		8 minutes max
Composition of solder paste		96.5Sn/3Ag/0.5Cu
Solder Paste Model		SHENMAO PF606-P26

9. Packaging

250 pcs AP.10G.01 reel
 Dimensions - 330 x 330 x 40mm
 Weight -1100g

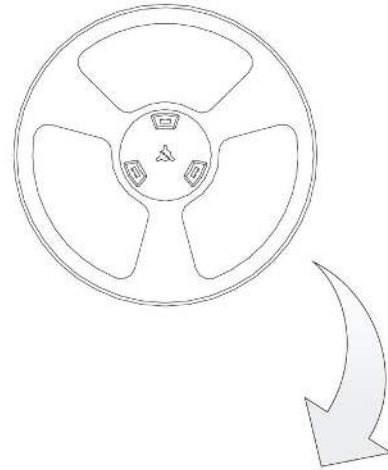

250 pcs AP.10G.01
 in small box
 Dimensions - 350 x 350 x 50mm
 Weight -1.4Kg

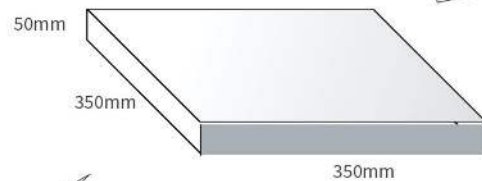

5 reels, 1250 pcs
 in one carton
 Carton Dimensions - 370 x 370 x 300mm
 Weight - 7.7Kg

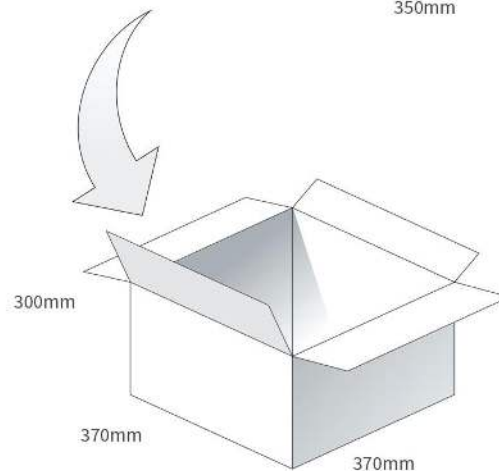

Pallet Dimensions 1200 x 1000 x 1350mm
 24 Cartons per Pallet
 6 Cartons per layer
 4 Layers

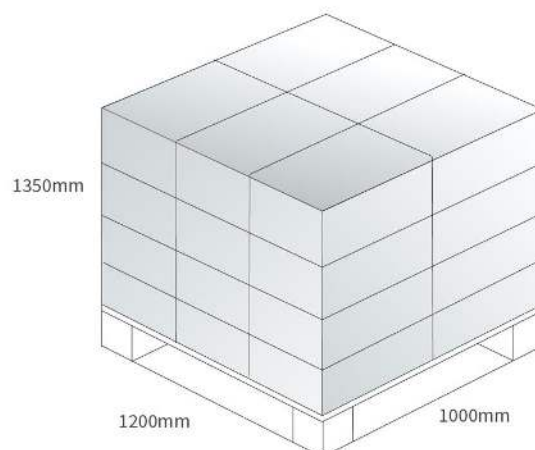

Changelog for the datasheet

SPE-11-8-100 - AP.10G.01

Revision: H (Current Version)

Date:	2022-02-22
Changes:	Updated GNSS Bands & Constellations Graphics
Changes Made by:	Cesar Sousa

Previous Revisions

Revision: G

Date:	2021-11-01
Changes:	Updated Data.
Changes Made by:	Gary West

Revision: B

Date:	2012-01-18
Changes:	
Changes Made by:	Staff

Revision: F

Date:	2021-10-07
Changes:	Added MSL, updated format
Changes Made by:	Erik Landi

Revision: A (Original First Release)

Date:	2011-10-14
Notes:	Initial Release
Author:	Staff

Revision: E

Date:	2014-05-13
Changes:	Added reflow
Changes Made by:	AINE DOYLE

Revision: D

Date:	2012-04-03
Changes:	
Changes Made by:	Staff

Revision: C

Date:	2012-03-07
Changes:	
Changes Made by:	Staff



TAOGLAS®

www.taoglas.com

