

## 1. Scope

The SCC series X1/Y1 safety capacitors are designed specifically for use in modem, facsimile, telephone and other electronic equipment.

These parts are compliant to , EN60384-14, IEC60384-14, UL60384-14.

**(This product compliant with the RoHS & HF and Pb free.)**

## 2. Parts Number Code

SCC	3906	X	471	K	8C2	T	S
(1)	(2)	(3)	(4)	(5)	(6)	(7)	(8)

### (1)Product

Product Code	
SCC	Safety Approval of MLCC Product

### (2)Chip Size

Code	Length×Width	unit : mm(inch)
<b>3906</b>	<b>9.70 × 1.80</b>	<b>(.38 x .06)</b>
4007	10.4 × 1.90	(.41 x .08)
4012	10.4 × 3.50	(.41 x .14)

### (3)Temperature Characteristics

Code	Temperature Characteristic	Temperature Range	Temperature Coefficient
N	NPO	-55℃~+125℃	30 ppm/℃
<b>X</b>	<b>X7R</b>	<b>-55℃~+125℃</b>	<b>± 15%</b>

### (4)Capacitance unit :pico farads(pF)

Code	Nominal Capacitance (pF)
100	10.0
<b>471</b>	<b>470.0</b>
182	1,800.0

※. If there is a decimal point, it shall be expressed by an English capital letter R

### (5)Capacitance Tolerance

Code	Tolerance	Nominal Capacitance
J	± 5.00 %	<b>More Than 10 pF</b>
<b>K</b>	<b>± 10.0 %</b>	
M	± 20.0 %	

### (6) Class Level of Capacitors

Code	Class
8A2	X1/Y1, AC250V
8B2	X1/Y1, AC300V
<b>8C2</b>	<b>X1/Y1, AC400V</b>

### (7) Packaging

Code	Type
<b>T</b>	<b>Tape &amp; 7" Reel</b>
R	Tape & 13" Reel
B	Bulk
W	Waffle Pack

### (8)Special Requirement Code

Code	Type
G	Normal Type(pb free compliant)
X	Pb free&Polymer Termination (Super Termination)
<b>S</b>	<b>Pb free&amp;Arc Prevention coating</b>
Z	Pb free&Arc Prevention coating & Polymer Termination

### 3. Nominal Capacitance and Tolerance

#### 3.1 Standard Combination of Nominal Capacitance and Tolerance

Class	Characteristic	Tolerance		Nominal Capacitance
Class I	NPO	Less Than 10 pF	C ( $\pm 0.25$ pF)	0.5,1,1.5,2,2.5,3,3.5,4,4.5,5
			D ( $\pm 0.50$ pF)	5,6,7,8,9,10
			E ( $\pm 1.00$ pF)	6,7,8,9,10
		More Than 10 pF	J ( $\pm 5.00$ %)	E-24 series
K ( $\pm 10.0$ %)				
Class II	X7R	K ( $\pm 10.0$ %), M ( $\pm 20.0$ %)		E-12 series

#### 3.2 E series(standard Number)

Standard No.	Application Capacitance											
E-3	1.0			2.2				4.7				
E-6	1.0		1.5		2.2		3.3		4.7		6.8	
E-12	1.0	1.2	1.5	1.8	2.2	2.7	3.3	3.9	4.7	5.6	6.8	8.2
E-24	1.0	1.2	1.5	1.8	2.2	2.7	3.3	3.9	4.7	5.6	6.8	8.2
	1.1	1.3	1.6	2.0	2.4	3.0	3.6	4.3	5.1	6.2	7.5	9.1

### 4. Operation Temperature Range

Class	Characteristic	Temperature Range	Reference Temp.
I	NPO	-55°C ~ +125°C	25°C
II	X7R	-55°C ~ +125°C	25°C

### 5. Storage Condition

Storage Temperature : 5 to 40°C

Relative Humidity : 20 to 70 %

Storage Time : 12 months max.

**6. Dimensions**

**6.1 Configuration and Dimension :**

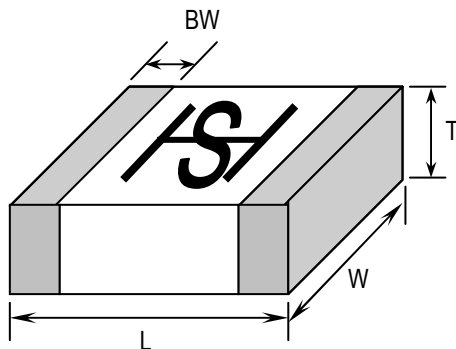

Unit:mm

TYPE	L	W	T	BW (min)
3906	9.70±0.30	1.80 ±0.20	1.80 ±0.20	0.30

**6.2 Termination Type :**

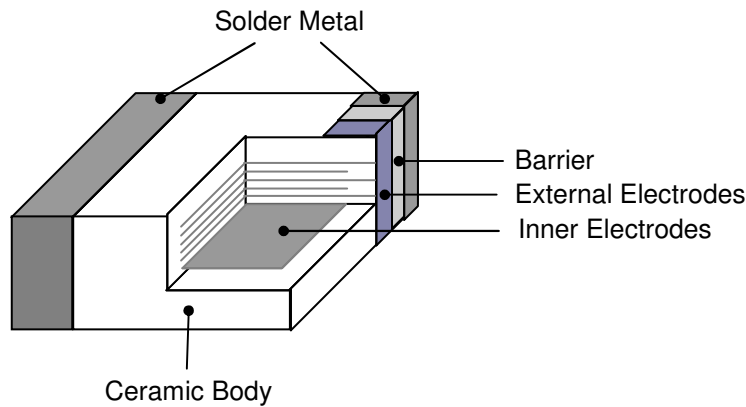

**7. Electronic Nominal Specification**

**7.1 Safety Standard:**

TUV : IEC 60384-14:2013+A1 EN 60384-14:2013+A1  
UL :UL 60384-14

**7.2 Rated Capacitance:**

**X7R :**

Type	Capacitance (pF)
SCC3906X	100, 120, 150, 180, 220, 270, 330, 390, 470
SCC4007X	100, 120, 150, 180, 220, 270, 330, 390, 470, 560, 680
SCC4012X	100, 120, 150, 180, 220, 270, 330, 390, 470, 560, 680, 820, 1000, 1200, 1500, 1800

**NPO :**

Type	Capacitance (pF)
SCC3906N	10, 11, 12, 13, 15, 16, 18, 20, 22, 24, 27, 30, 33, 36, 39, 43, 47, 51, 56, 62, 68, 75, 82, 91, 100

**8. Performance**

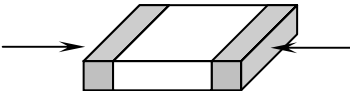
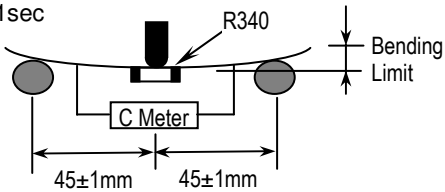
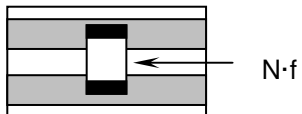
No.	Item	Specification	Test Condition	
1	Visual	No abnormal exterior appearance	Visual Inspection	
2	Dimension	See Page 3 / Item 6.	Visual Inspection	
3	Capacitance	Within the specified tolerance	Char.          Frequency          Voltage	
4	Q and Dissipation Factor	Class I (NPO) More than 30pF : $Q \geq 1000$ 30pF & below: $Q \geq 400 + 20C$ (C:pF) Class II (X7R) Maximum : 2.5% (0.025)	NPO $C \leq 1000\text{pF}$ $1\text{MHz} \pm 10\%$ $1.0 \pm 0.2\text{Vrms}$ $C > 1000\text{pF}$ $1\text{KHz} \pm 10\%$	
			X7R $1\text{KHz} \pm 10\%$ $1.0 \pm 0.2\text{Vrms}$ After performing deage at $150 \pm 5\%$ for 30min. and placement room temperature for $24 \pm 2\text{hr}$ .	
5	Insulation Resistance	Minimum 10,000M $\Omega$	Applied Voltage: Applied Voltage:500V Charge Time : 60sec.	
6	Voltage Proof	No dielectric breakdown or mechanical breakdown	Applied Voltage: X1-250V Capacitor :Applied Voltage 1075Vdc(4.3Ur) X1-300V Capacitor :Applied Voltage 1290Vdc(4.3Ur) X1-400V Capacitor :Applied Voltage 1720Vdc(4.3Ur) Y1 Capacitor :Applied Voltage 4000Vac For 1min. Voltage ramp up rate $\leq 150\text{V/sec}$ (for Vac Test) charge/discharge Current is less than 50mA.	
7	Solderability	More than 90% of the terminal surface is to be soldered newly, so metal part does not come out or dissolve 	Solder Temperature : $245 \pm 5^\circ\text{C}$ Dip Time : $5 \pm 0.5$ sec. Immersing Speed : $25 \pm 10\%$ mm/s Solder : Lead Free Solder Flux :Rosin Preheat : At $80 \sim 120^\circ\text{C}$ For 10~30sec.	
8	Resistance to Flexure of Substrate	Appearance	No mechanical damage shall occur.	
		Capacitance	Characteristic	Cap. Change
			Class I (NPO)	$\leq \pm 5.0\%$ of initial value
		Class II (X7R)	$\leq \pm 12.5\%$ of initial value	
		Q / D.F.	To satisfy the specified initial value	
		Insulation Resistance	To satisfy the specified initial value	
Voltage Proof	To satisfy the specified initial value			
			Bending shall be applied to the 1.0 mm with 1.0 mm/sec. The duration of the applied forces shall be $5 \pm 1$ sec  Solder the capacitor on P.C. board shown in Fig 1. before testing.	
9	Robustness of Shear	Appearance	No indication of peeling shall occur on the terminal electrode.	
		Capacitance	Characteristic	Cap. Change
			Class I (NPO)	$\leq \pm 5.0\%$ of initial value
		Class II (X7R)	$\leq \pm 12.5\%$ of initial value	
		Q / D.F.	To Satisfy The Specified Initial Value	
		Insulation Resistance	To Satisfy The Specified Initial Value	
Voltage Proof	To Satisfy The Specified Initial Value			
			Pull force shall be applied for $10 \pm 1$ second. $10\text{N} (\approx 1.0 \text{ Kg}\cdot\text{f})$  Solder the capacitor on P.C. board shown in Fig 1. before testing.	

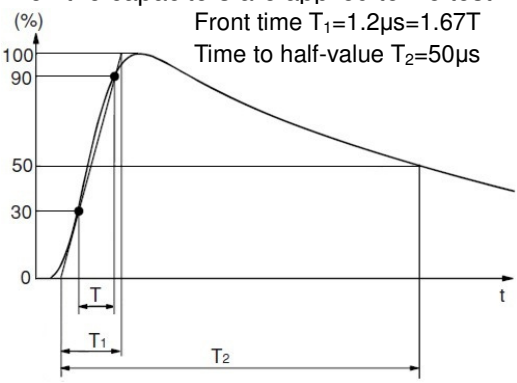
No.	Item	Specification	Test Condition		
10	Resistance To Soldering Heat	Appearance	Class II capacitor shall be set for 48±4 hours at room temperature after one hour heat treatment at 150 +0/-10°C before initial measure. Preheat : At 150± 10°C For 60~120sec. Dip : Solder Temperature of 260± 5°C Dip Time : 10 ± 1sec. Flux :Rosin Measure at room temp. after cooling for: Class I : 24 ± 2 Hours Class II : 48 ± 4 Hours		
		Capacitance		Characteristic	Cap. Change
				Class I (NPO)	≤ ± 10% of initial value
		Q / D.F.		Class II (X7R)	≤ ± 20% of initial value
				To satisfy the specified initial value	
Insulation Resistance	More than 1,000MΩ				
Voltage Proof	To Satisfy The Specified Initial Value				
11	Damp Heat / Steady State	Appearance	Test Condition : Temperature : 40°C Humidity : 95 %RH Test Time : 500hr (21days) The capacitors with rated voltage(250Vac) applied. Measure at room temp. after cooling for: Class I :24 ± 2 Hrs Class II :48 ± 4 Hrs  Solder The Capacitor On P.C. Board Shown In Fig 2. Before Testing.		
		Capacitance		Characteristic	Cap. Change
				Class I (NPO)	≤ ± 15% of initial value
		Q		Class II (X7R)	≤ ± 15% of initial value
				Class I	More Than 30pF : Q ≥ 350 30pF & Below:Q ≥ 275+2.5× C (C:pF)
		D.F. Class II		Maximum 5.0%	
Insulation Resistance	More Than 1,000MΩ				
Voltage Proof	To Satisfy The Specified Initial Value				
12	Endurance	Appearance	Impulse Voltage Each individual capacitor shall be subjected to a 8KV(X1/Y1) impulse for three times. Then the capacitors are applied to life test. Front time T <sub>1</sub> =1.2μs=1.67T Time to half-value T <sub>2</sub> =50μs    Temperature : 125°C Test Time : 1000hrs Applied Voltage (X1/Y1) : Class Y-250VCapacitors :1.7Ur (425Vac) Class Y-300VCapacitors :1.7Ur (510Vac) Class Y-400VCapacitors :1.7Ur (680Vac) Except that once every hour the voltage shall be increased to 1000Vrms for 0.1s.		
		Capacitance		Characteristic	Cap. Change
				Class I (NPO)	≤ ± 20% of initial value
		Q		Class II (X7R)	≤ ± 20% of initial value
				Class I	More Than 30pF : Q ≥ 350 30pF & Below:Q ≥ 275+2.5×C (C:pF)
		D.F. Class II		Maximum 5.0%	
Insulation Resistance	Minimum 1,000MΩ				
Voltage Proof	To satisfy the specified initial value				

No.	Item	Specification	Test Condition
13	Passive Flammability	Capacitor didn't burnt at all	Volume Sample : 21.56mm <sup>3</sup> Flame exposure time : 5 sec.Max.
14	Active Flammability	The cheese cloth shall not burn with a flame	The X- capacitors of class each test capacitors applied .  Then each sample shall be subjected to 20 discharges from a tank capacitor, charge to a voltage that, when discharged, places Ui(4KV) across the capacitor under test. The interval between successive discharges shall be 5s.

**8.1 P.C. Board for Bending Strength Test**

(referring to IEC384-14 and EN132400)

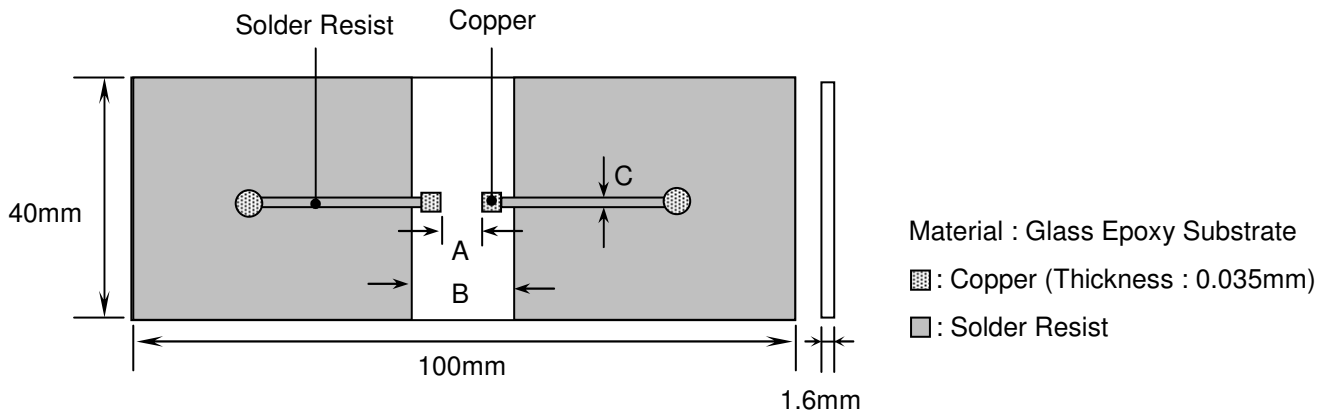

**9. Packing**

**9.1 Bulk Packing**

According to customer request.

**9.2 Cover Tape Reel Off Force**

**9.2.1 Peel-Off Force**

$$5 \text{ g}\cdot\text{f} \leq \text{Peel-Off Force} \leq 70 \text{ g}\cdot\text{f}$$

**9.2.2 Measure Method**

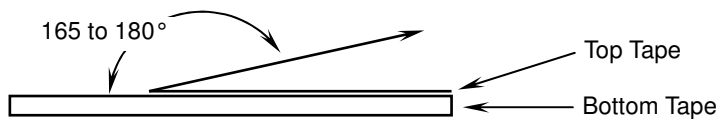

**9.3 Plastic Tape**

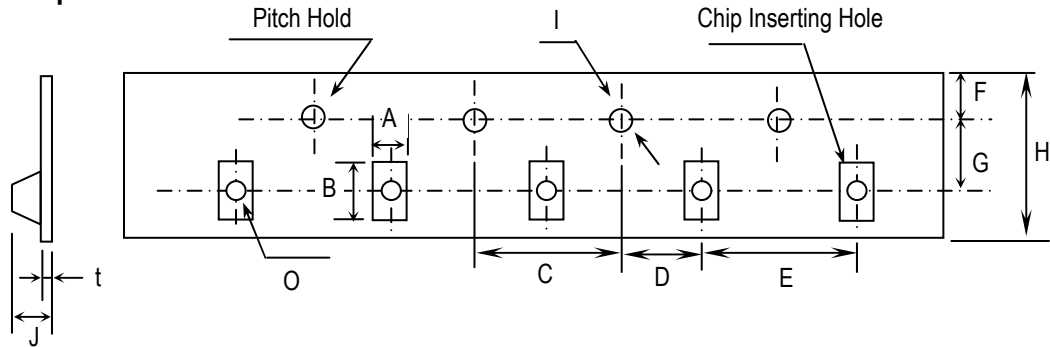

Unit:mm

Unit:mm

Type	A	B	C	D	E	F
3906	2.2± 0.1	9.3± 0.1	4.0± 0.1	2.0± 0.1	8.0± 0.1	1.75± 0.1
4007	2.3± 0.1	10.9± 0.1				
4012	3.9± 0.1	10.9± 0.1				

Type	G	H	I	J	t	O
3906	11.5± 0.1	24.0± 0.3	φ1.5± 0.1	1.90± 0.1	0.35± 0.05	NA
4007				2.20± 0.1		
4012				2.70± 0.1		

**9.4 Reel Dimensions**

Reel Material : Polystyrene

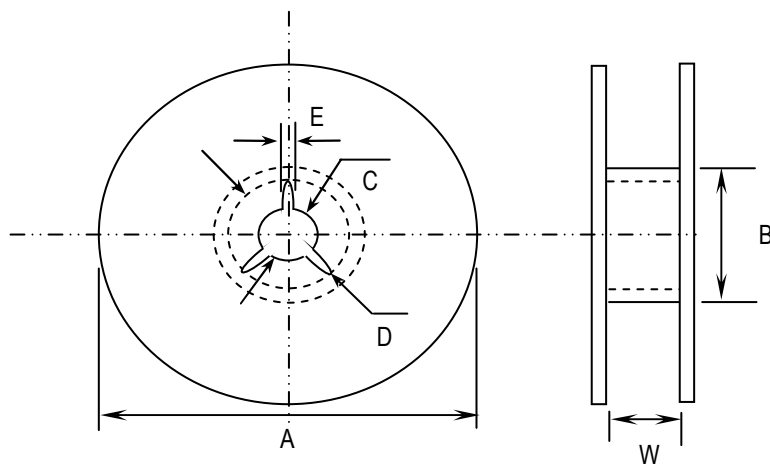

Unit:mm

Type	A	B	C	D	E	W
3906	179± 0.1	60.0± 0.5	13.2± 0.2	φ21± 0.8	2.2± 0.2	28.4± 2.0
4007						
4012						



## Caution

### 1. Storage

Store the capacitors where the temperature and relative humidity don't exceed 40°C and 70%RH. We recommend that the capacitors be used within 12 months from the date of manufacturing. Store the products in the original package and do not open the outer wrapped, polyethylene bag, till just before usage. If it is open, seal it as soon as possible or keep it in a desiccant with a desiccation agent.

### 2. Construction of Board Pattern

Improper circuit layout and pad/land size may cause excessive or not enough solder amount on the PC board. Not enough solder may create weak joint, and excessive solder may increase the potential of mechanical or thermal cracks on the ceramic capacitor. Therefore we recommend the land size to be as shown in the following table:

2.1 Size and recommend land dimensions for reflow soldering.

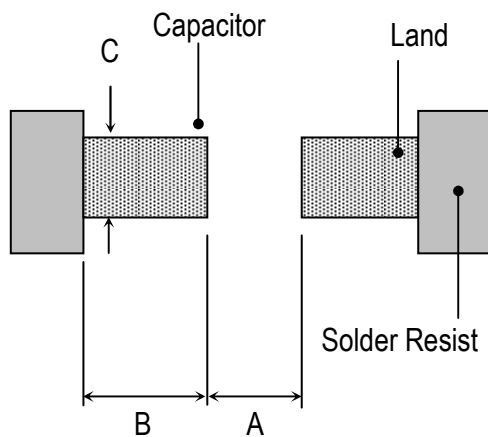

EIA Code	Chip (mm)		Land (mm)		
	L	W	A	B	C
3906	9.70	1.80	8.0	2.2	2.0~3.6
4007	10.4	1.90	8.0	2.2	2.0~3.6
4012	10.4	3.60	8.0	2.2	2.0~3.6

2.2 Mechanical strength varies according to location of chip capacitors on the P.C. board.

Design layout of components on the PC board such a way to minimize the stress imposed on the components, upon flexure of the boards in depanelization or other processes.

Component layout close to the edge of the board or the “depanelization line” is not recommended.

Susceptibility to stress is in the order of: a>b>c and d>e

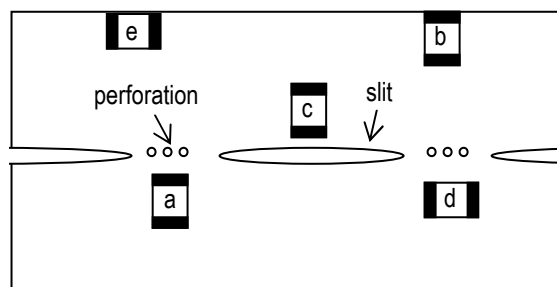

2.3 Layout Recommendation

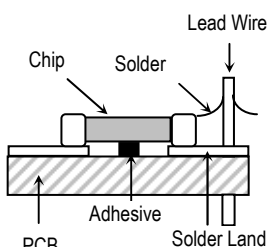
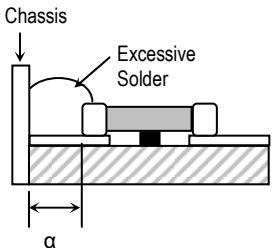
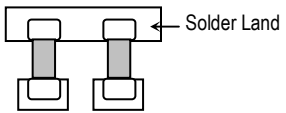
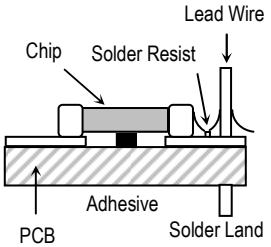
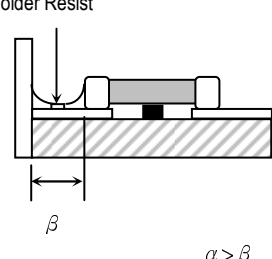
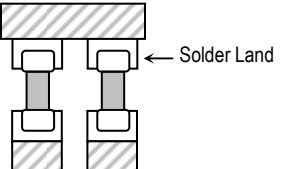
Example	Use of Common Solder Land	Solder With Chassis	Use of Common Solder Land With Other SMD
Need to Avoid			
Recommendation			

3. Mounting

3.1 Sometimes Crack is caused by the impact load due to suction nozzle in pick and place operation.

In pick and place operation, if the low dead point is too low, excessive stress is applied to component. This may cause cracks in the ceramic capacitor, therefore it is required to move low dead point of a suction nozzle to the higher level to minimize the board warp age and stress on the components. Nozzle pressure is typically adjusted to 1N to 3N (static load) during the pick and place operation.

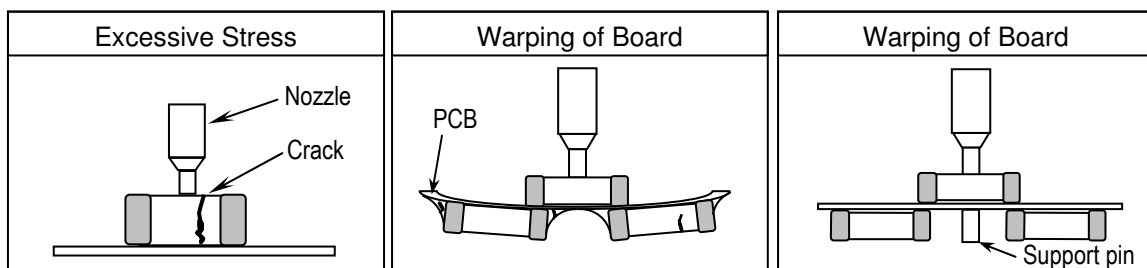

3.2 Amount of Adhesive

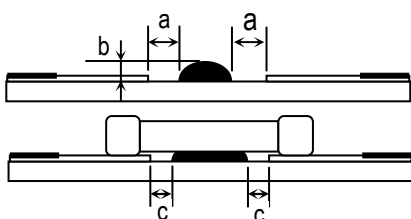

Example : 0805 & 1206

a	0.2mm min.
b	70 ~ 100 μm
c	Do not touch the solder land

#### 4. Soldering

##### 4.1. Wave Soldering

Most of components are wave soldered with solder at Peak Temperature.. Adequate care must be taken to prevent the potential of thermal cracks on the ceramic capacitors. Refer to the soldering methods below for optimum soldering benefits.

##### Recommend flow soldering temperature Profile

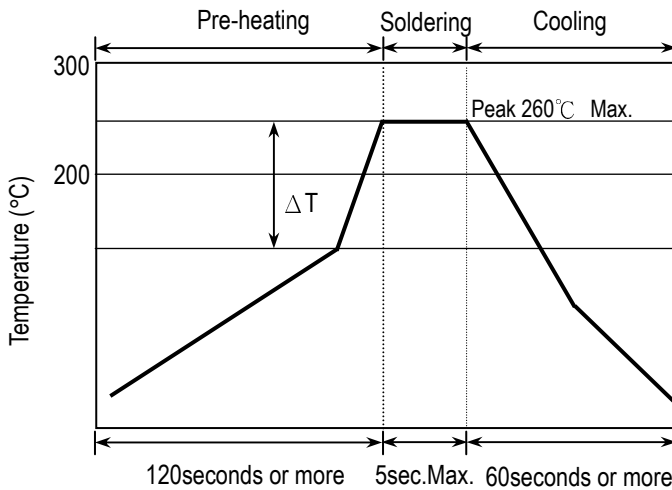

Soldering Method	Peak Temp.( °C) / Duration (sec)
1206/0805/0603	$\Delta T \leq 100 \sim 150^{\circ}\text{C}$ max.
Pb-Sn Solder	250°C (max.) / 3sec(max.)
Lead Free Solder	260°C (max.) / 5sec(max.)

Recommended solder compositions

Sn-37Pb (Pb - Sn Solder)

Sn-3.0Ag-0.5Cu (Lead Free Solder)

To optimize the result of soldering, proper preheating is essential:

- 1) Preheat temperature is too low
  - a. Flux flows to easily
  - b. Possibility of thermal cracks
- 2) Preheat temperature is too high
  - a. Flux deteriorates even when oxide film is removed
  - b. Causes warping of circuit board
  - c. Loss of reliability in chip and other components

Cooling Condition:

Natural cooling using air is recommended. If the chips are dipped into a solvent for cleaning, the temperature difference ( $\Delta T$ ) between the solvent and the chips must be less than 100°C.

##### 4.2 Reflow Soldering

Preheat and gradual increase in temperature to the reflow temperature is recommended to decrease the potential of thermal crack on the components. The recommended heating rate depends on the size of component, however it should not exceed 3°C/Sec.

##### Recommend reflow profile for Lead-Free soldering temperature Profile (J-STD-020E)

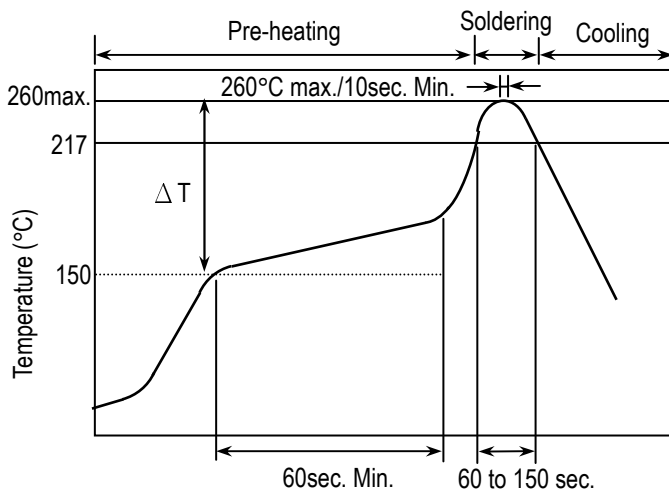

Soldering Method	Change in Temp.( °C)
1206 and Under	$\Delta T \leq 190^{\circ}\text{C}$
1210 and Over	$\Delta T \leq 130^{\circ}\text{C}$

※ The cycles of soldering : Three times (max.)

Maximum Ramp-up = 3°C/Sec.

Maximum Ramp-down Rate = 6°C/Sec.

### 4.3 Hand Soldering

Sudden heating of the components results in distortion due to a high internal temperature differential, causing cracked chips. When preheating, keep temperature differential  $\Delta T$ , within the range shown in table. The smaller the  $\Delta T$ , the less stress on the chip.

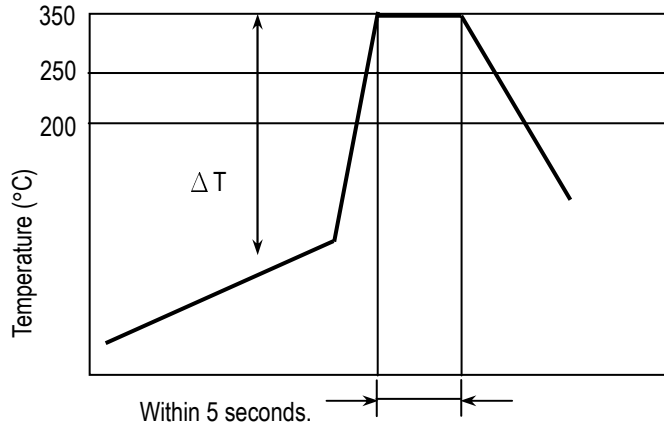

Soldering Method	Change in Temp.(°C)
1206 and Under	$\Delta T \leq 150^\circ\text{C}$
1210 and Over	$\Delta T \leq 130^\circ\text{C}$

#### How to Solder Repair by Solder Iron

##### 1) Selection of the soldering iron tip

Tip temperature of solder iron varies by its type, P.C.board material and solder land size. Higher the tip temperature, quicker the operation is, but the heat shock may crack the chip capacitor.

##### 2) recommended solder iron condition

- a.) Preheating Condition : Board and components should be preheated sufficiently at  $150^\circ\text{C}$  or over, and soldering should be conducted with soldering iron as boards and components are maintained at sufficient temperatures.
- b.) Soldering iron power shall not exceed 30 W.
- c.) Soldering iron tip diameter shall not exceed 3mm.
- d.) Temperature of iron tip shall not exceed  $350^\circ\text{C}$  and the process should be finished within 5 seconds. (refer to MIL-STD-202G)
- e.) Do not touch the ceramic dielectric with solder iron other than the terminations. Direct contact of the soldering iron with ceramic dielectric of chip capacitor may cause crack.
- f.) After soldering, let the products to cool down gradually in the room temperature.

✳ **The soldering to lose the use of electronic heat gun.**

### 5. Handling after chip mounted

5.1 Please pay attention put the component lateral to the direction in which stress acts.

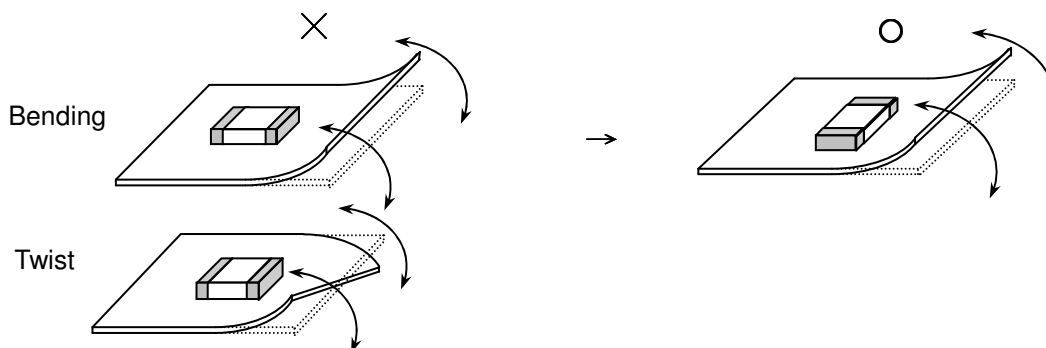

5.2 Crack will be caused if board is warped due to excessive load by check pin.

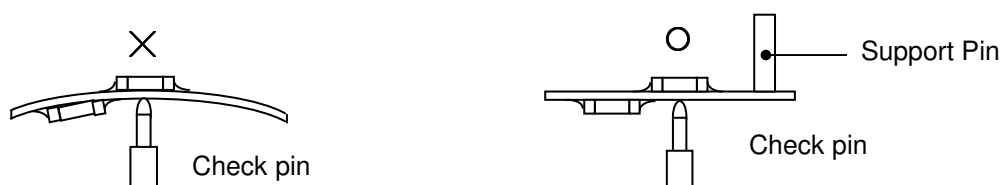

5.3 Mechanical stress due to warping and torsion by dividing.

- (a) Crack occurrence ratio will be increased by manual separation.
- (b) Crack occurrence ratio will be increased by tensile force , rather than compressive force.

× :Tensile Stress

○ :Compressive Stress

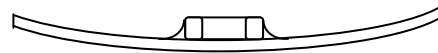
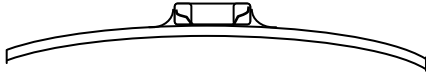

**Capacitor Stress Analysis**

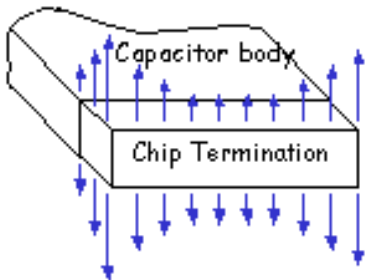

**Failure mode: chip crack by stress**



**6. Handling of Loose Chip Capacitor**

6.1 If dropped the chip capacitor may crack.

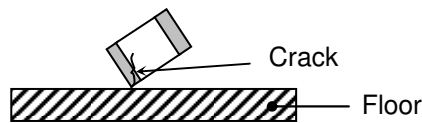

6.2 Piling the P.C. board after mounting for storage or handling, the corner of the P.C. board may hit the chip capacitor of another of board to cause crack.

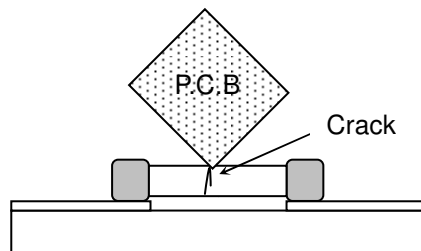

**7. Safekeeping condition and period**

For safekeeping of the products, we recommend to keep storage temperature +5 ~+40°C , Humidity 20 ~70%RH and use them within 12 months.