

PRODUCT NUMBER
10106814-0XX0X2LF

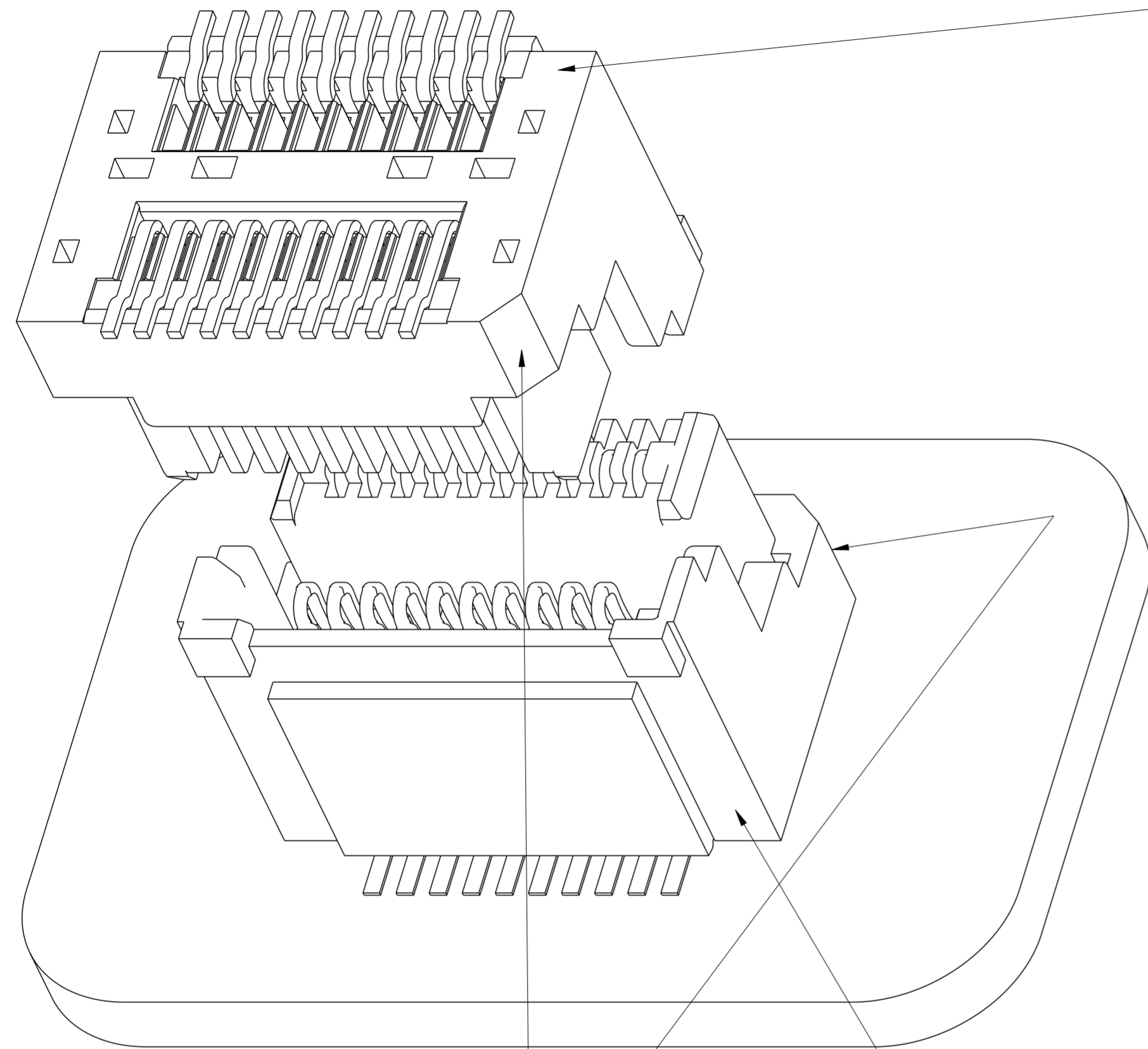

10106814-0XX0X2LF
HERMAPHRODITIC CONNECTOR
ASSEMBLY

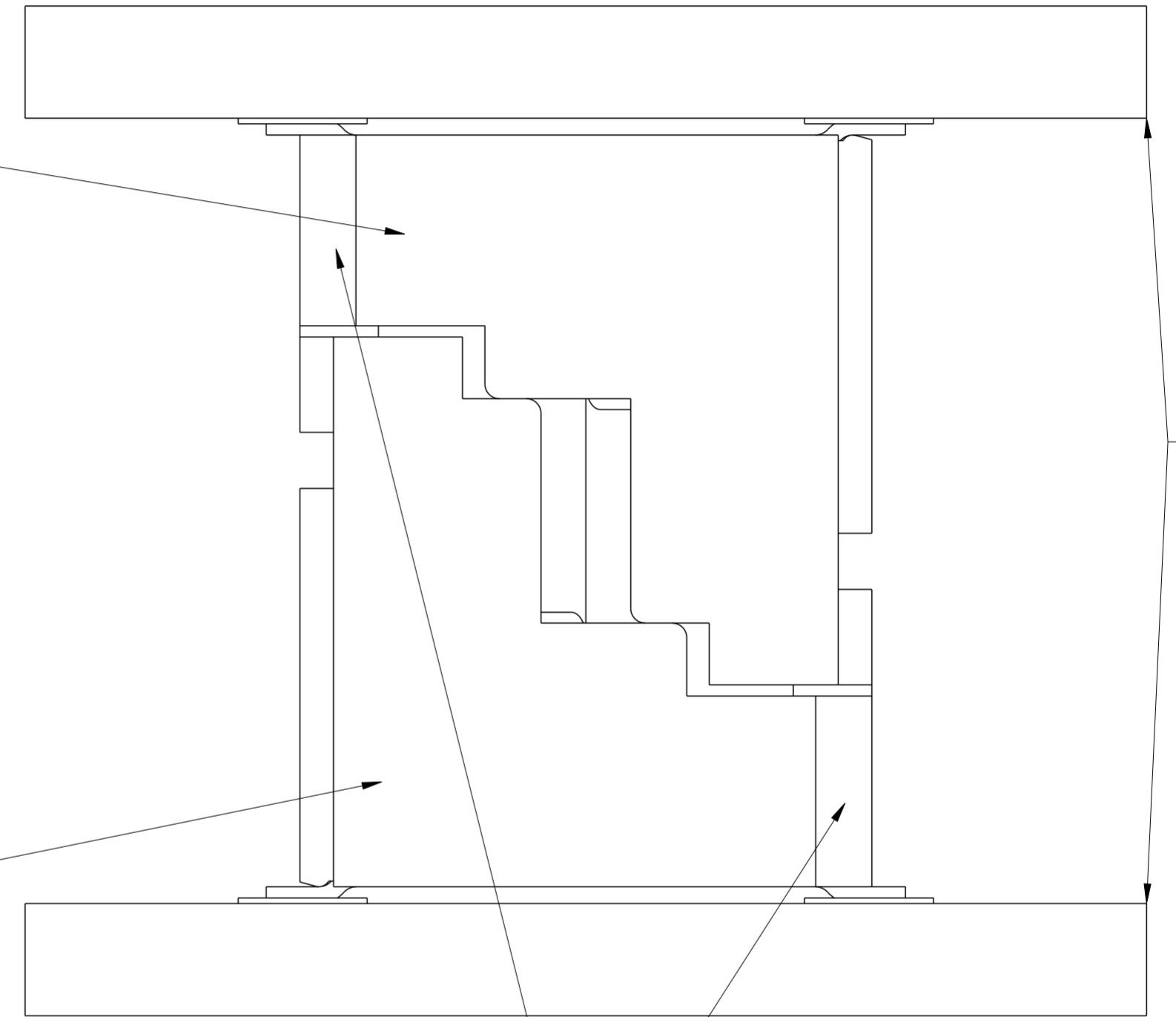

PRINTED
CIRCUIT
BOARD

CONNECTOR ORIENTATION
FEATURE
SEE PCB LAYOUT ON PAGE 5

10106814-0XX0X2LF
HERMAPHRODITIC CONNECTOR
ASSEMBLY

CONNECTOR ORIENTATION
FEATURE
SEE PCB LAYOUT ON PAGE 5

Amphenol
FCi

© 2020 Amphenol Corporation

spec ref	---	dr	Stu Stoner	2010/11/22	projection	mm	size	A2	scale	20:1
tolerance std	ASME Y14.5	eng	Yuan-Yuan Bao	2022/04/06	chr	-	ecn no	ELX-N-44329-1		
TOLERANCES UNLESS OTHERWISE SPECIFIED		appr	Tim Yao	2022/04/08	product family	MezzoStak	rel level	Released		
surface	linear	0.X	±0.3	Amphenol FCi	TITLE	HERMAPHRODITIC CONNECTOR, SHORT STYLE	dwg no	10106814	rev	E
		0.XX	±0.15							
		0.XXX	±0.05							
ASME Y14.5	angular	0°	±3°	www.fci.com	cat. no.	-	Product - Customer Drw	sheet 1 of 8		

PDS: Rev :E

STATUS:Released

Printed: May 24, 2022

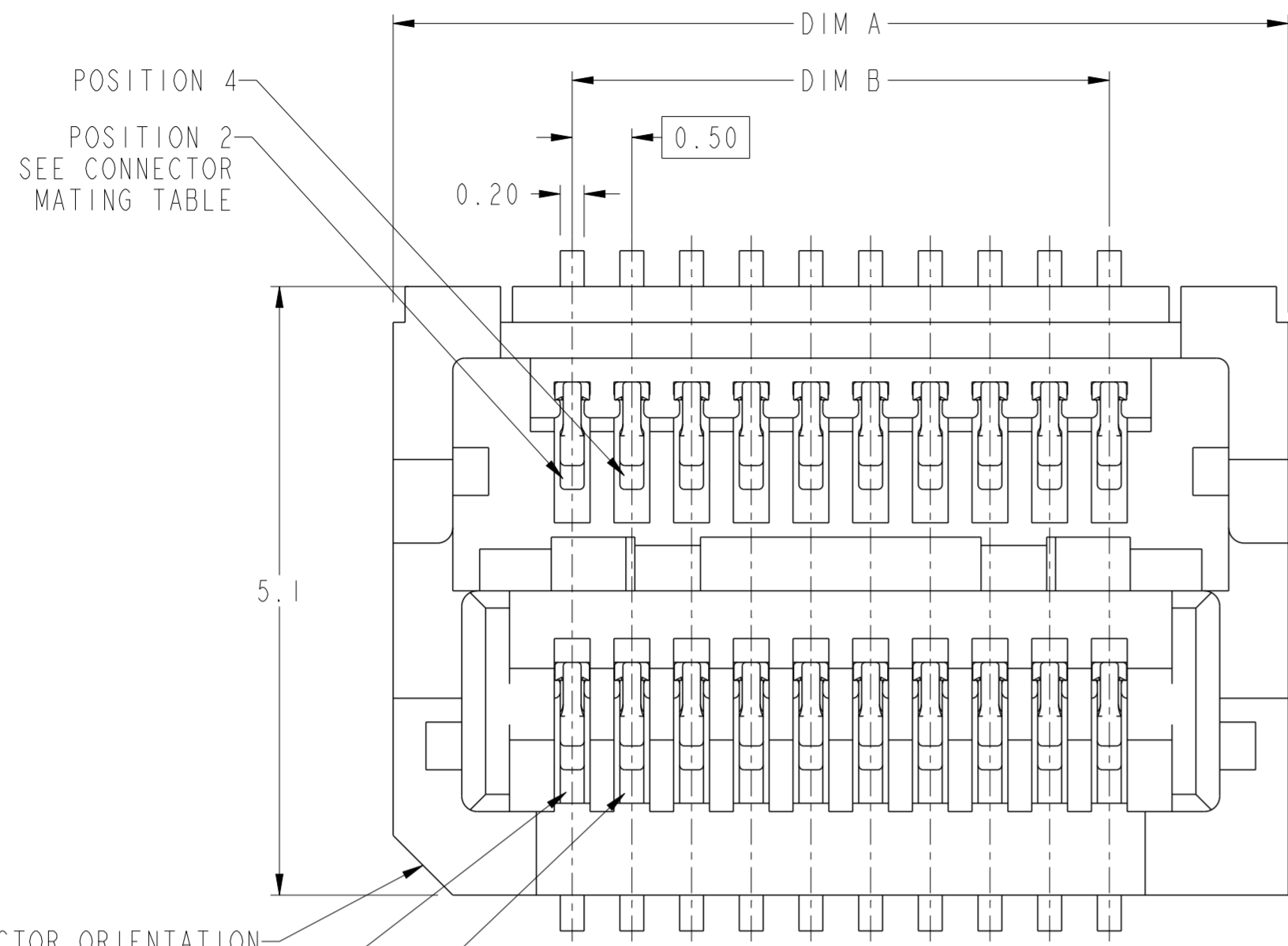

POSITION 4
 POSITION 2
 SEE CONNECTOR
 MATING TABLE

CONNECTOR ORIENTATION
 FEATURE

POSITION 1
 SEE CONNECTOR
 MATING TABLE

POSITION 3

5.1

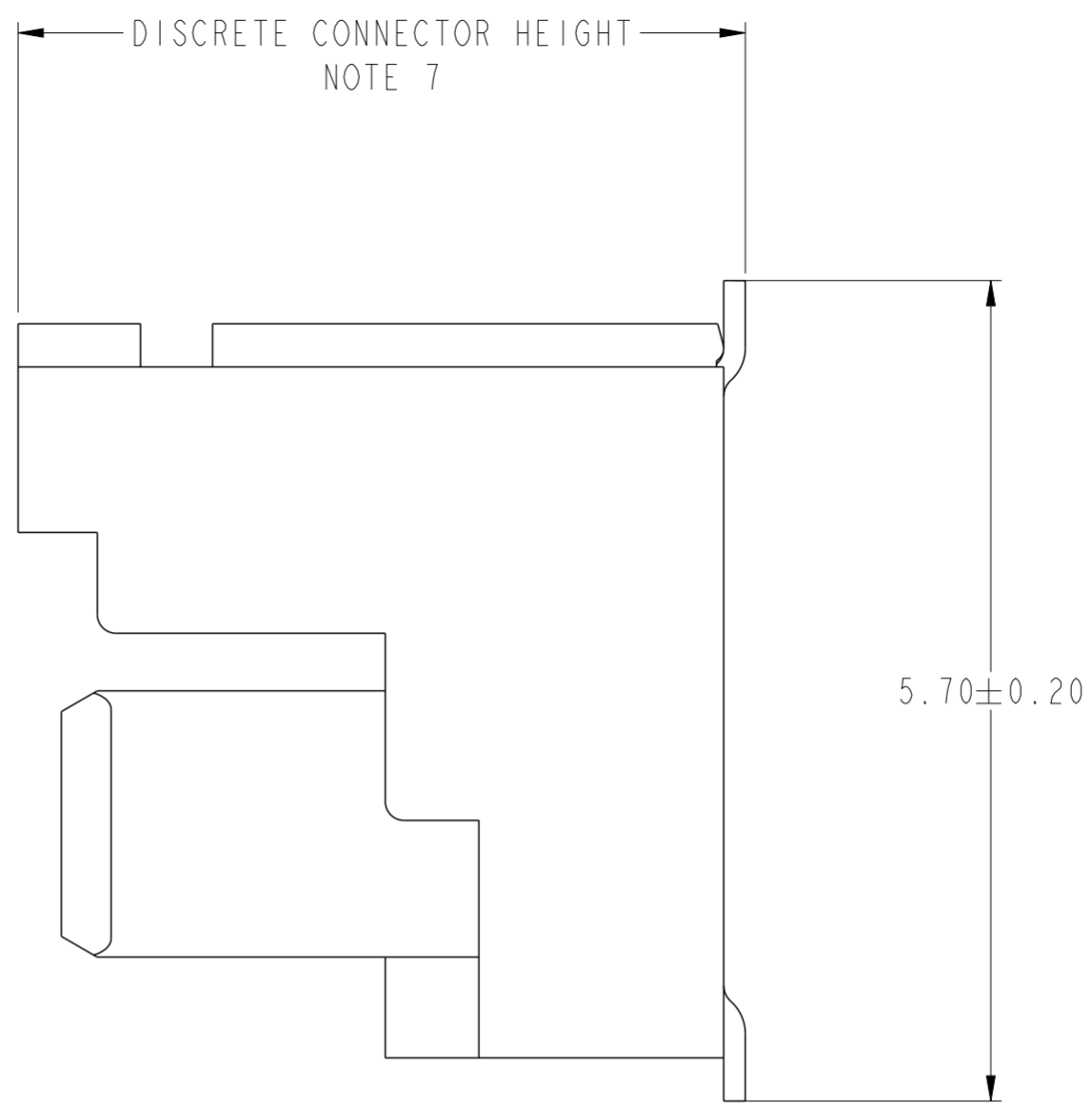

HERMAPHRODITIC CONNECTOR MATING	
CONNECTOR POSITION	MATES WITH CONNECTOR POSITION
1	2
3	4
5	6
7	8
9	10
ETC.	

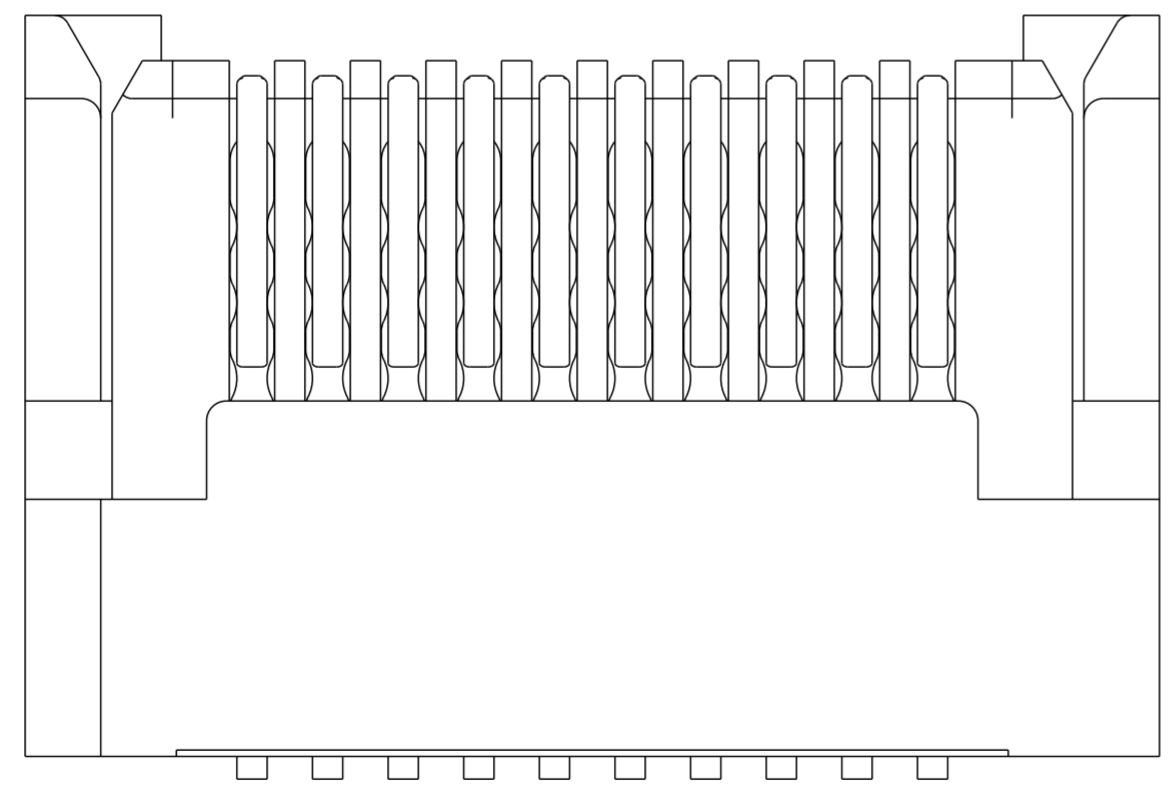

10106814-024002LF SHOWN
 WITHOUT STANDARD PICK-UP CAP

Amphenol
 FCI

© 2020 Amphenol Corporation

spec ref	---	dr	Stu Stoner	2010/11/22	projection	mm	size	A2	scale	20:1		
tolerance std	ASME Y14.5	eng	Yuan-Yuan Bao	2022/04/06			ecn no	ELX-N-44329-1				
TOLERANCES UNLESS OTHERWISE SPECIFIED		chr	-	appr			Tim Yao	2022/04/08	product family	MezzoStack		
surface	✓	Amphenol FCI		title			HERMAPHRODITIC CONNECTOR, SHORT STYLE		div no	10106814		
ASME Y14.5	linear	0.X	±0.3	0.XX	±0.15	0.XXX	±0.05	angular	0°	±3°		
www.fci.com		cat. no.		-		Product - Customer Drw		sheet 2 of 8				

PDS: Rev :E

STATUS:Released

Printed: May 24, 2022

	1	2	3	4	5	6	7	8
	PRODUCT NUMBER	NUMBER OF POSITIONS	DIM A	DIM B	DISCRETE CONNECTOR HEIGHT NOTE 9	PRACTICAL CONNECTOR HEIGHT NOTE 8	DIM.E OVER ALL HEIGHT (CAP IS INCLUDED)	STATUS
A	10106814-021002LF	20	7.5	4.5	3.55	2.00	4.05	RELEASED
	10106814-031002LF	30	10.0	7.0				
	10106814-041002LF	40	12.5	9.5				
	10106814-051002LF	50	15.0	12.0				
	10106814-061002LF	60	17.5	14.5				
	10106814-071002LF	70	20.0	17.0				
	10106814-081002LF	80	22.5	19.5				
B	10106814-022002LF	20	7.5	4.5	4.05	2.50	4.55	UN-RELEASED
	10106814-032002LF	30	10.0	7.0				
	10106814-042002LF	40	12.5	9.5				
	10106814-052002LF	50	15.0	12.0				
	10106814-062002LF	60	17.5	14.5				
	10106814-072002LF	70	20.0	17.0				
	10106814-023002LF	20	7.5	4.5				
C	10106814-033002LF	30	10.0	7.0	4.55	3.00	5.05	RELEASED
	10106814-043002LF	40	12.5	9.5				
	10106814-053002LF	50	15.0	12.0				
	10106814-063002LF	60	17.5	14.5				
	10106814-073002LF	70	20.0	17.0				
	10106814-083002LF	80	22.5	19.5				
	10106814-083202LF	80	22.5	19.5				
	10106814-093002LF	90	25.0	22.0				
	10106814-093012LF	90	25.0	22.0				
	10106814-093202LF	90	25.0	22.0				
10106814-024002LF	20	7.5	4.5					
D	10106814-034002LF	30	10.0	7.0	5.05	3.50	5.55	UN-RELEASED
	10106814-044002LF	40	12.5	9.5				
	10106814-054002LF	50	15.0	12.0				
	10106814-064002LF	60	17.5	14.5				
	10106814-074002LF	70	20.0	17.0				

0.5 BTB HERMAPHRODITIC CONNECTOR ASSEMBLY PART NUMBER SCHEME

EXAMPLE: 10106814-XX X X X 2 LF

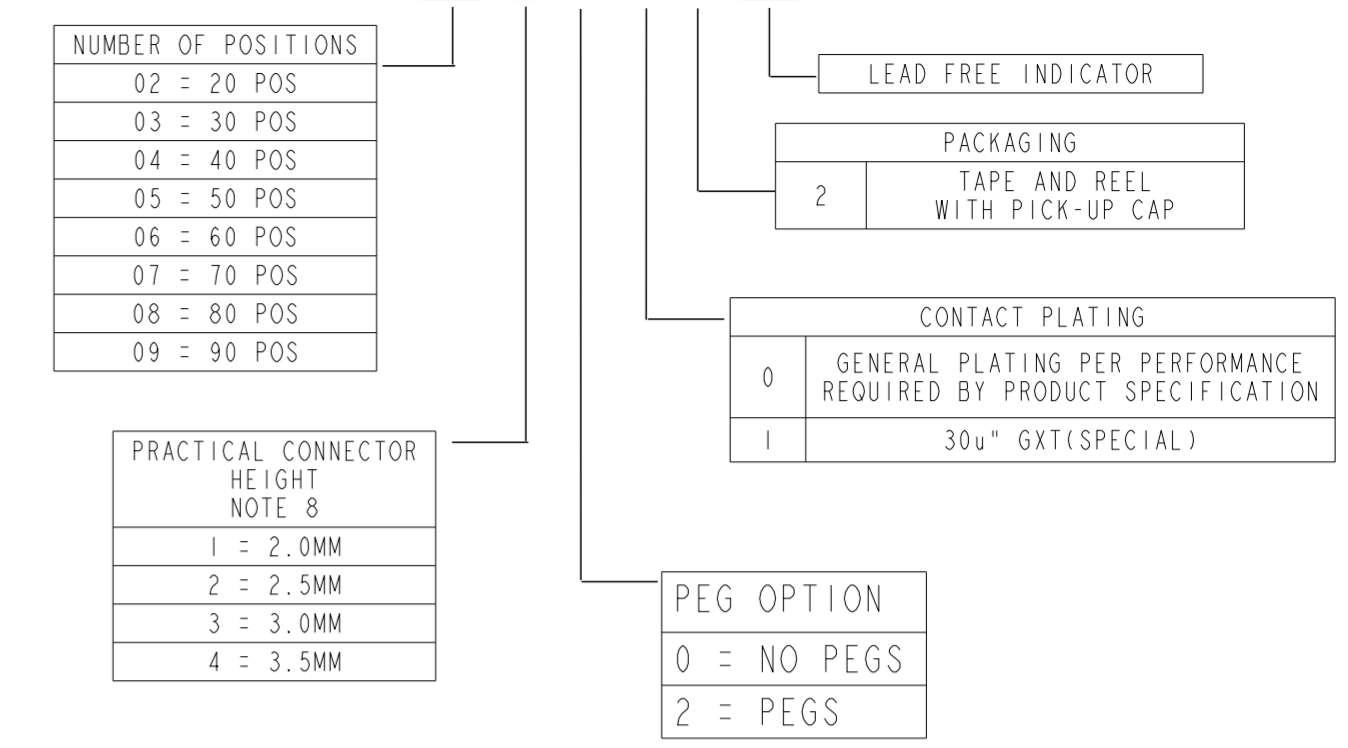

Amphenol FCI
© 2020 Amphenol Corporation

spec ref	---	dr	Stu Stoner	2010/1/22	projection	mm	size	A2	scale	10:1
tolerance std	ASME Y14.5	eng	Yuan-Yuan Bao	2022/04/06	chr	-	ecn no	ELX-N-44329-1	rel level	Released
surface	ASME Y14.5	appr	Tim Yao	2022/04/08	product family	MezzoStak	part no	10106814	rev	E
TOLERANCES UNLESS OTHERWISE SPECIFIED		Amphenol FCI		HERMAPHRODITIC CONNECTOR, SHORT STYLE		cat. no.		Product - Customer Drw		sheet 3 of 8
linear	0.X ±0.3 0.XX ±0.15 0.XXX ±0.05	angular	0° ±3°	www.fci.com		20-90 POS, 0.5MM CTR, 4-7MM STACK HT				

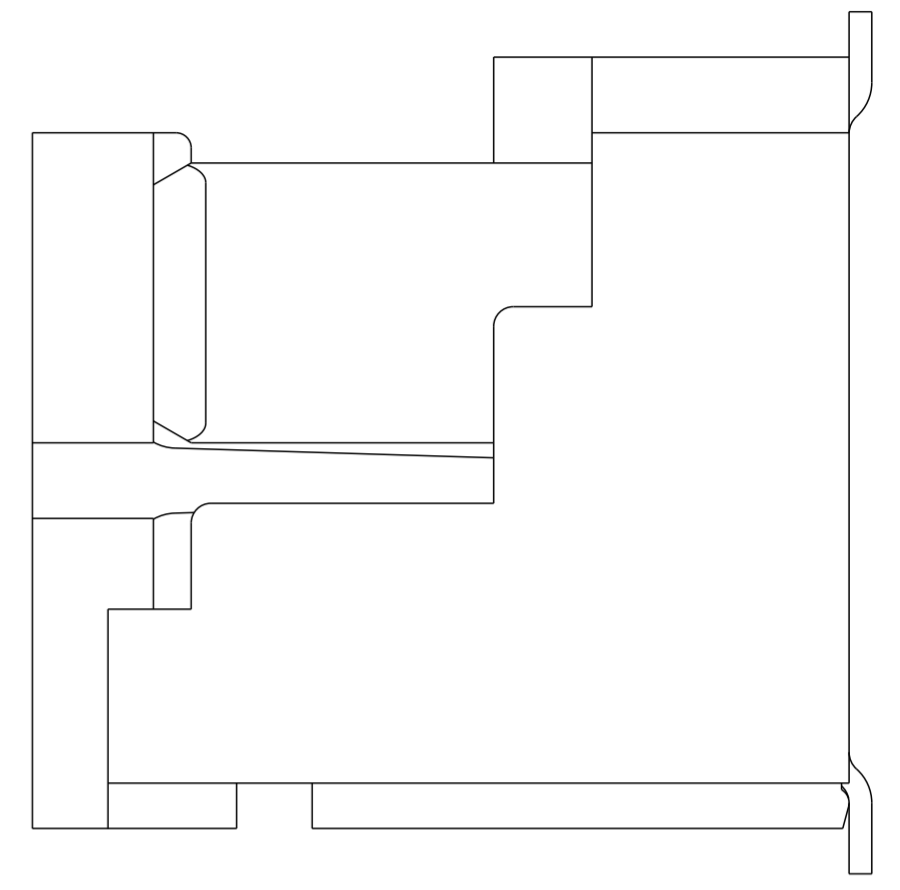
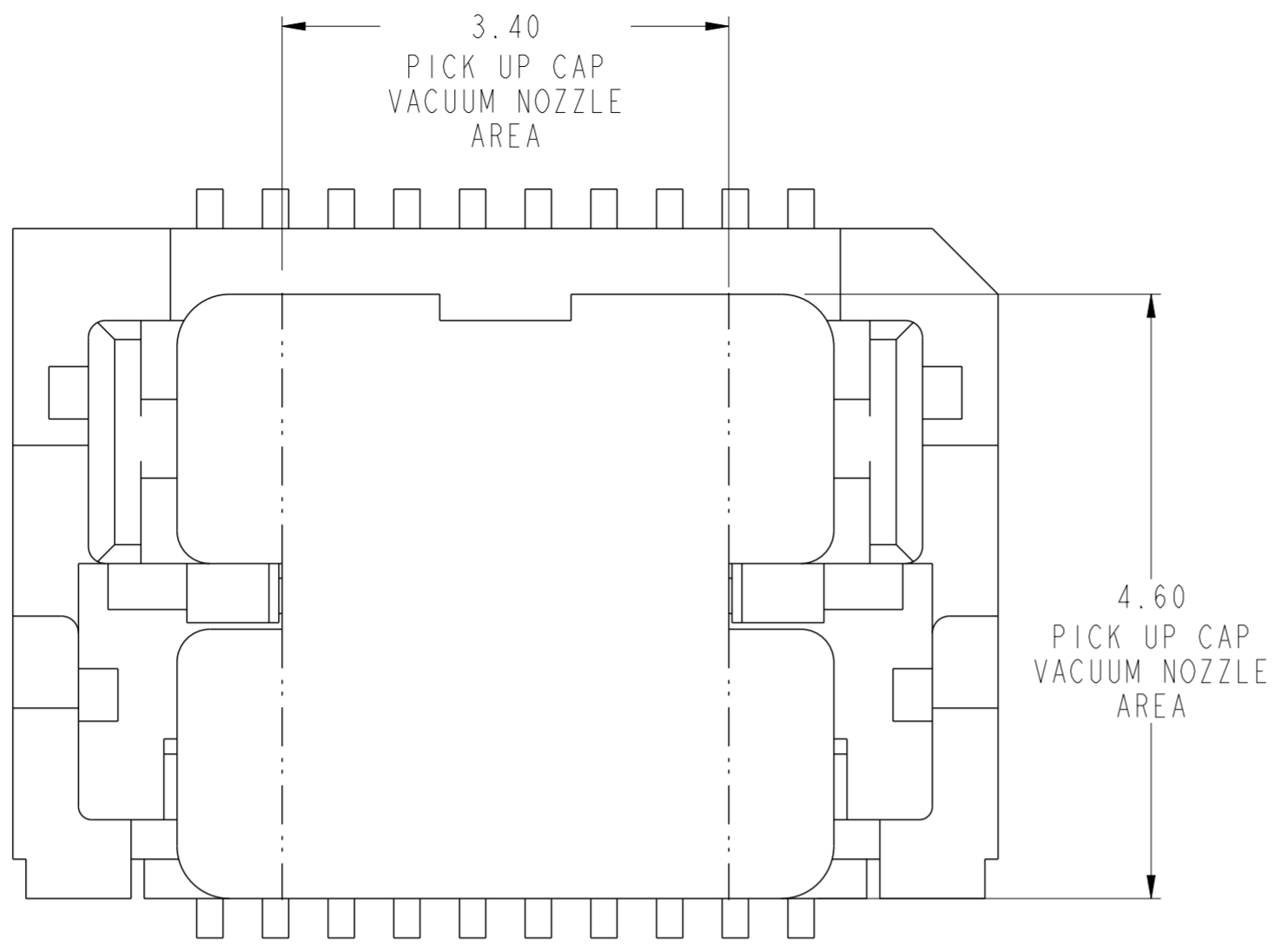

10106814-024002LF SHOWN
WITH STANDARD PICK-UP CAP

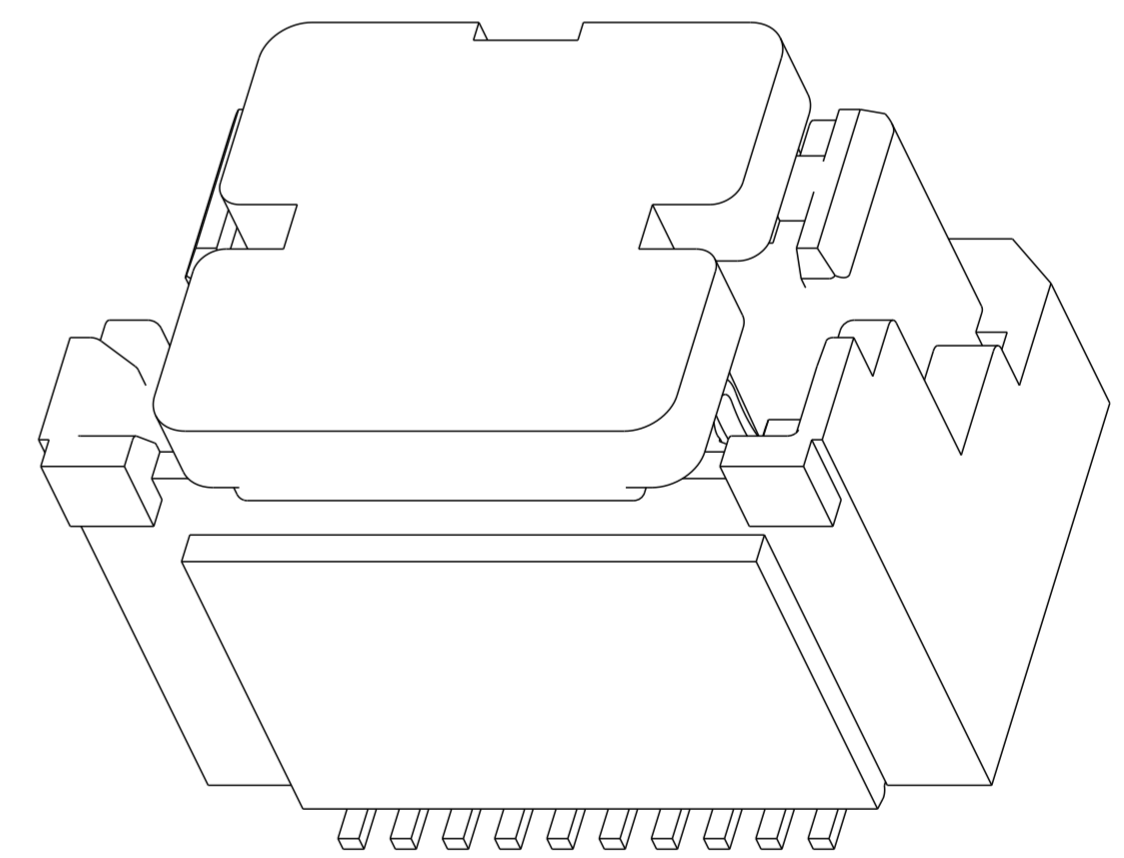
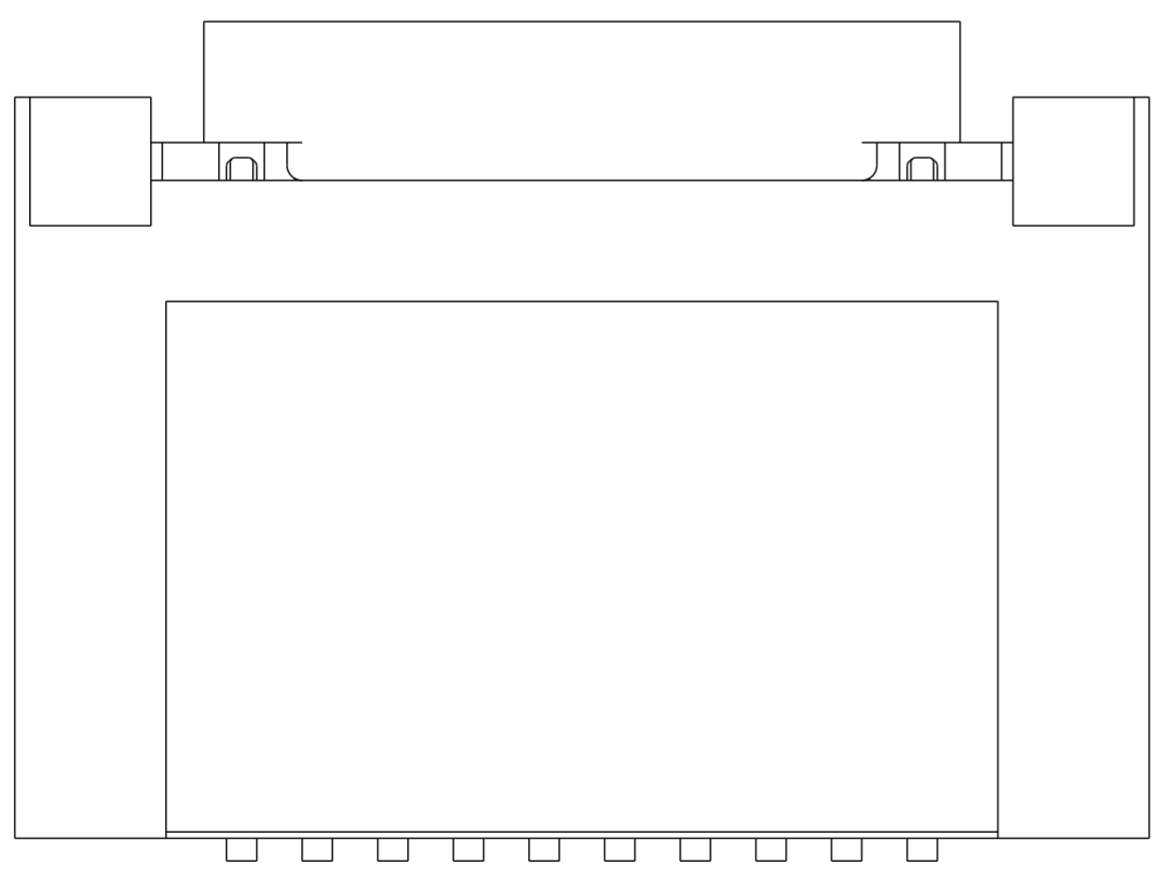

PLEASE REFER PAGE 3 TO GET THE DETAILED DIMENSION VALUE OF DIM.E

Amphenol
FCi

© 2020 Amphenol Corporation

spec ref	---	dr	Stu Stoner	2010/1/22	projection	mm	size	A2	scale	20:1
tolerance std	ASME Y14.5	eng	Yuan-Yuan Bao	2022/04/06	chr	-	ecn no	ELX-N-44329-1	rel level	Released
TOLERANCES UNLESS OTHERWISE SPECIFIED		appr	Tim Yao	2022/04/08	product family	MezzoStak	cat. no	10106814	rev	E
surface	✓	linear	0.X	±0.3	Amphenol FCi	title	HERMAPHRODITIC CONNECTOR, SHORT STYLE	div no		
			0.XX	±0.15	www.fci.com		20-90 POS, 0.5MM CTR, 4-7MM STACK HT			
		angular	0°	±3°			Product - Customer Drw		sheet 4 of 8	

PDS: Rev :E

STATUS:Released

Printed: May 24, 2022

PRODUCT NUMBER	NUMBER OF POSITIONS	DIM A	DIM B	DIM C	PEGS STATUS	DIM_D
10106814-02X002LF	20	2.25	4.50	7.50	NO	N/A
10106814-03X002LF	30	3.50	7.00	10.00	NO	N/A
10106814-04X002LF	40	4.75	9.50	12.50	NO	N/A
10106814-05X002LF	50	6.00	12.00	15.00	NO	N/A
10106814-06X002LF	60	7.25	14.50	17.50	NO	N/A
10106814-07X002LF	70	8.50	17.00	20.00	NO	N/A
10106814-08X002LF	80	9.75	19.50	22.50	NO	N/A
10106814-09X0X2LF	90	11.00	22.00	25.00	NO	N/A
10106814-08X202LF	80	9.75	19.50	22.50	YES	22.00
10106814-09X202LF	90	11.00	22.00	25.00	YES	24.50

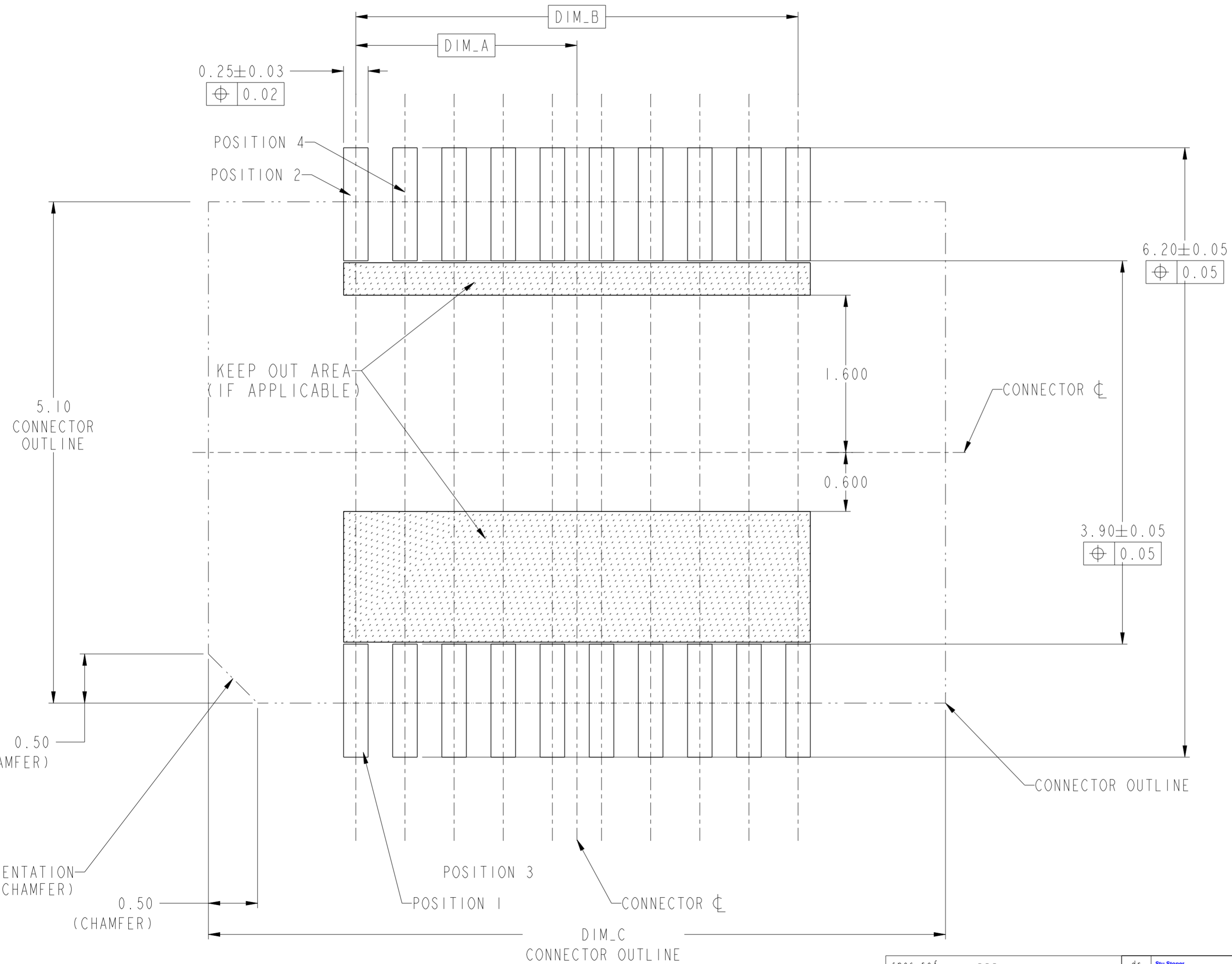

OPTION 1 - SPACE OPTIMIZED FOOTPRINT
SEE TABLE FOR CONNECTOR LAYOUT DIMENSIONS
SEE NOTE 8 FOR STENCIL CREATION GUIDELINES

spec ref	---	dr	Stu Stoner	2010/11/22	projection	mm	size	A2	scale	30:1
tolerance std	ASME Y14.5	eng	Yuan-Yuan Bao	2022/04/06	chr	-	ecn no	ELX-N-44329-1	rel level	Released
surface	linear	0.X	±0.3	Amphenol FCI	title	HERMAPHRODITIC CONNECTOR, SHORT STYLE	cat. no.	10106814	rev	E
		0.XX	±0.15	www.fci.com		20-90 POS, 0.5MM CTR, 4-7MM STACK HT				
		0.XXX	±0.05							
	angular	0°	±3°							

PRODUCT NUMBER	NUMBER OF POSITIONS	DIM A	DIM B	DIM C	PEGS STATUS	DIM_D
10106814-02X002LF	20	2.25	4.50	7.50	NO	N/A
10106814-03X002LF	30	3.50	7.00	10.00	NO	N/A
10106814-04X002LF	40	4.75	9.50	12.50	NO	N/A
10106814-05X002LF	50	6.00	12.00	15.00	NO	N/A
10106814-06X002LF	60	7.25	14.50	17.50	NO	N/A
10106814-07X002LF	70	8.50	17.00	20.00	NO	N/A
10106814-08X002LF	80	9.75	19.50	22.50	NO	N/A
10106814-09X0X2LF	90	11.00	22.00	25.00	NO	N/A
10106814-08X202LF	80	9.75	19.50	22.50	YES	22.00
10106814-09X202LF	90	11.00	22.00	25.00	YES	24.50

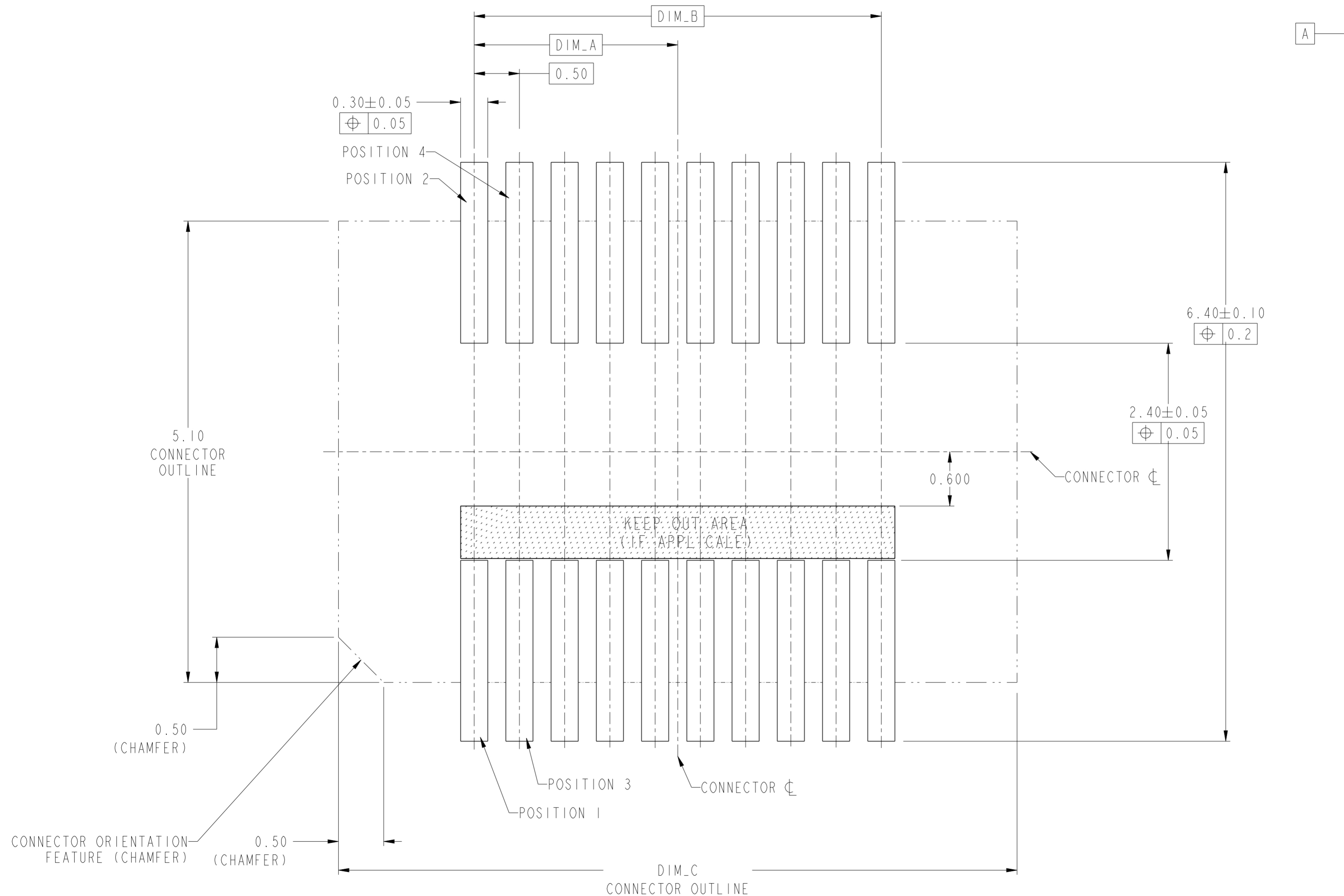

OPTION 2 - FOOTPRINT
SEE TABLE FOR CONNECTOR LAYOUT DIMENSIONS
SEE NOTE 8 FOR STENCIL CREATION GUIDELINES

spec ref	---	dr	Siu Stoner	2010/11/22	projection	mm	size	A2	scale	10:1
tolerance std	ASME Y14.5	eng	Yuan-Yuan Bao	2022/04/06	chr	-	ecn no	ELX-N-44329-1	rel level	Released
surface	linear	app	Tim Yao	2022/04/08	product family	MezzoStak	title	HERMAPHRODITIC CONNECTOR, SHORT STYLE	div no	10106814
ASME Y14.5	angular	www.fci.com	cat. no.	-	Product - Customer Drw	sheet 6 of 8	rev	E		

10106814-0932X2LF SHOWN

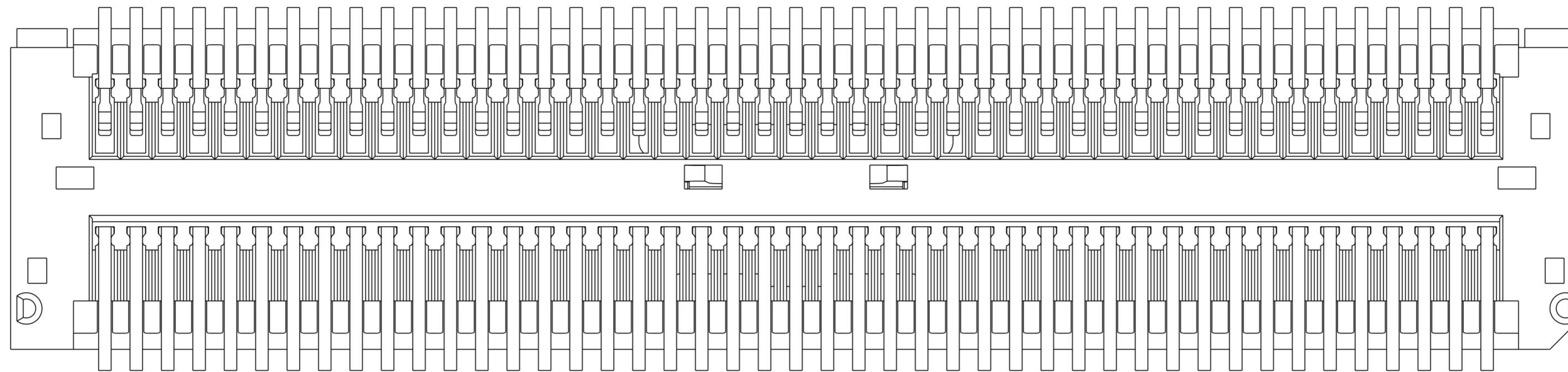

SCALE 15:1

2X (Ø0.50) PEGS FEATURE
ONLY FOR 10106814-083202LF
AND 10106814-093202LF

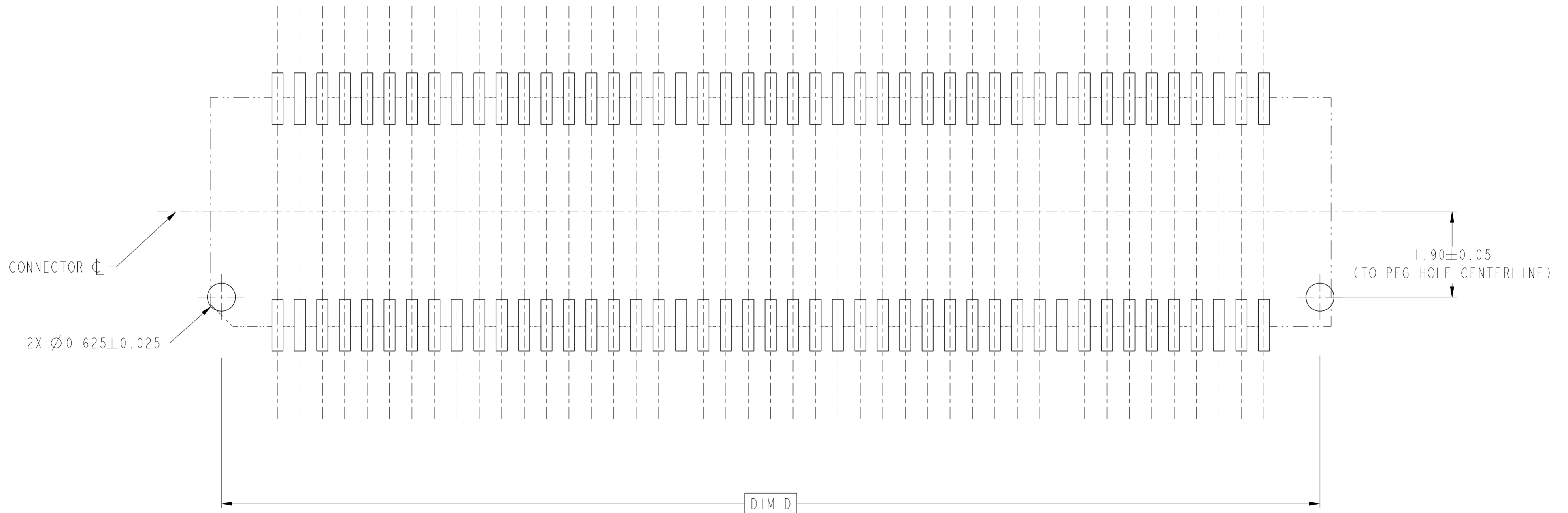

PCB LAYOUT FOR 10106814-083202LF AND 10106814-093202LF
OTHER DIMENSIONS, SEE SHEET 5 AND 6

SCALE 15:1

spec ref	---	dr	Stu Stoner	2010/11/22	projection	mm	size	A2	scale	10:1
tolerance std	ASME Y14.5	eng	Yuan-Yuan Bao	2022/04/06	chr	-	ecn no	ELX-N-44329-1	rel level	Released
TOLERANCES UNLESS OTHERWISE SPECIFIED		appr	Tim Yao	2022/04/08	product family	MezzoStack	rel level	Released		
surface	linear	0.X	±0.3	Amphenol FCI TITLE HERMAPHRODITIC CONNECTOR, SHORT STYLE 20-90 POS, 0.5MM CTR, 4-7MM STACK HT www.fci.com cat. no.	divg no	10106814	rev	E		
		0.XX	±0.15							
		0.XXX	±0.05							
ASME Y14.5	angular	0°	±3°		Product - Customer Drw	sheet 7 of 8				

PDS: Rev :E

STATUS:Released

Printed: May 24, 2022

Amphenol FCI

© 2020 Amphenol Corporation

NOTES

- 1 - MATERIAL:
 HOUSING - HIGH-TEMPERATURE THERMOPLASTIC, UL94-V0, COLOR: BLACK
 CONTACTS: COPPER ALLOY
 CONTACT PLATING:
 SEPARABLE INTERFACE: PERFORMANCE-BASED PLATING, QUALIFIED TO MEET THE REQUIREMENTS OF FCI PRODUCT SPECIFICATION.
 SOLDER TAILS: GOLD FLASH.
- 2 - RECOMMENDED LEAD FREE SOLDER PASTE THICKNESS 150µm.
- 3 - THE HOUSING WILL WITHSTAND EXPOSURE TO 260°C PEAK TEMPERATURE FOR 30 SECONDS IN A CONVECTION INFRA RED OR VAPOR PHASE REFLOW OVEN.
- 4 - THIS PRODUCT MEETS EUROPEAN UNION DIRECTIVES AND OTHER COUNTRY REGULATION AS DESCRIBED IN GS-22-008
- 5 - PACKAGING TAPE AND REEL. PACKAGING SPECIFICATION GS-14-1320, PRODUCT SPECIFICATION GS-12-1322.
- 6 - PRACTICAL CONNECTOR HEIGHT AS SPECIFIED IN THE TABLE IS NOT THE DIMENSIONAL HEIGHT OF THE CONNECTOR BUT THE HEIGHT AS IT PERTAINS TO TOTAL STACK HEIGHT. AN EXAMPLE IS A CONNECTOR WITH A 2.5MM PRACTICAL CONNECTOR HEIGHT, WHEN MATED TO ITSELF WILL RESULTING IN A BOARD TO BOARD STACK HEIGHT OF 5MM.
- 7 - DISCRETE CONNECTOR HEIGHT AS SHOWN IN THE TABLE IS THE ACTUAL DIMENSIONAL CONNECTOR HEIGHT. ALSO SEE INFORMATION ON PRACTICAL HEIGHT IN NOTE 6.
- 8 - REFER TO IPC 7525-A FOR STENCIL CREATION.

Amphenol
FCI

© 2020 Amphenol Corporation

spec ref	---	dr	Stu Stoner	2010/1/22	projection		mm	size	A2	scale	20:1											
tolerance std	ASME Y14.5	eng	Yuan-Yuan Bao	2022/04/06	chr	-	ecn no	ELX-N-44329-1	rel level	Released												
surface	✓	appr	Tim Yao	2022/04/08	product family	MezzoStak	div no	10106814	rev	E												
ASME Y14.5	<table border="1"> <tr> <td>linear</td> <td>0.X</td> <td>±0.3</td> </tr> <tr> <td></td> <td>0.XX</td> <td>±0.15</td> </tr> <tr> <td></td> <td>0.XXX</td> <td>±0.05</td> </tr> <tr> <td>angular</td> <td>0°</td> <td>±3°</td> </tr> </table>	linear	0.X	±0.3		0.XX	±0.15		0.XXX	±0.05	angular	0°	±3°	Amphenol FCI	title	HERMAPHRODITIC CONNECTOR, SHORT STYLE 20-90 POS, 0.5MM CTR, 4-7MM STACK HT		cat. no.	-	Product - Customer Drw	sheet 8 of 8	
linear	0.X	±0.3																				
	0.XX	±0.15																				
	0.XXX	±0.05																				
angular	0°	±3°																				

PDS: Rev :E

STATUS:Released

Printed: May 24, 2022