

3-641212-4 ✓ ACTIVE



MTA 100

TE Internal #: 3-641212-4

PCB Mount Header, Right Angle, Wire-to-Board, 4 Position, 2.54 mm [.1 in] Centerline, Unshrouded, Gold, Through Hole - Solder, Signal, MTA 100

[View on TE.com >](#)

Connectors > PCB Connectors > PCB Headers & Receptacles > PCB Header: Polyester, Right Angle, Unshrouded

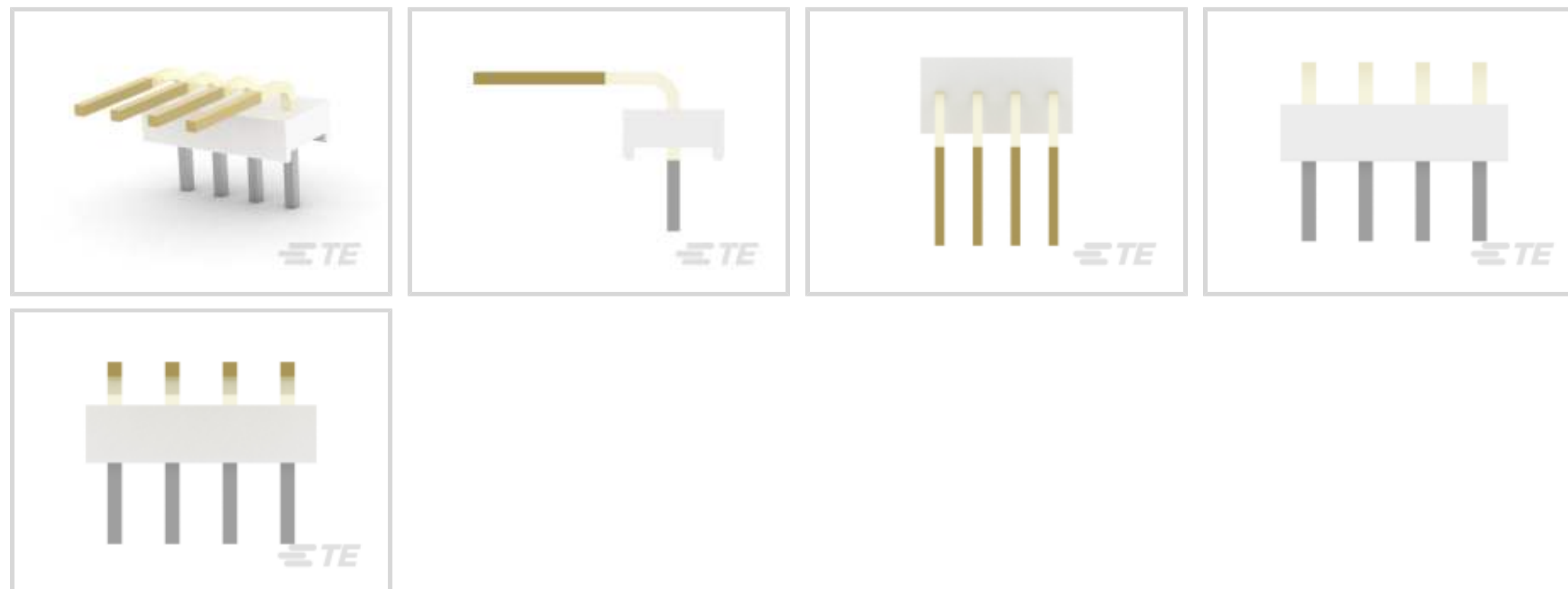

Connector System: **Wire-to-Board**

Number of Positions: **4**

Number of Rows: **1**

Centerline (Pitch): **2.54 mm [.1 in]**

PCB Mount Orientation: **Right Angle**

[All PCB Header: Polyester, Right Angle, Unshrouded \(80\)](#)

Features

Product Type Features

Connector System	Wire-to-Board
Header Type	Unshrouded
Sealable	No
Connector & Contact Terminates To	Printed Circuit Board
PCB Connector Assembly Type	PCB Mount Header

Configuration Features

Number of Positions	4
Number of Rows	1
PCB Mount Orientation	Right Angle

Electrical Characteristics

Operating Voltage	250 VAC
-------------------	---------

Body Features



Primary Product Color	Natural
-----------------------	---------

Contact Features

Contact Mating Area Length	7.49 mm[.295 in]
----------------------------	------------------

Mating Square Post Dimension	.64 mm[.025 in]
------------------------------	-----------------

PCB Contact Termination Area Plating Material Thickness	3.81 – 8.89 μ m[150 – 350 μ in]
---	---

Contact Layout	Inline
----------------	--------

Contact Underplating Material Thickness	1.27 μ m[50 μ in]
---	---------------------------

Contact Mating Area Plating Material Thickness	.38 μ m[15 μ in]
--	--------------------------

PCB Contact Termination Area Plating Material Finish	Matte
--	-------

Contact Shape & Form	Square
----------------------	--------

Contact Mating Area Plating Material Finish	Bright
---	--------

Contact Underplating Material	Nickel
-------------------------------	--------

PCB Contact Termination Area Plating Material	Tin
---	-----

Contact Base Material	Copper Alloy
-----------------------	--------------

Contact Mating Area Plating Material	Gold
--------------------------------------	------

Contact Type	Pin
--------------	-----

Contact Current Rating (Max)	5 A
------------------------------	-----

Termination Features

Square Termination Post & Tail Dimension	.64 mm[.025 in]
--	-----------------

Termination Post & Tail Length	3.56 mm[.14 in]
--------------------------------	-----------------

Termination Method to Printed Circuit Board	Through Hole - Solder
---	-----------------------

Mechanical Attachment

Mating Retention	Without
------------------	---------

Panel Mount Feature	Without
---------------------	---------

Connector Mounting Type	Board Mount
-------------------------	-------------

Mating Alignment	Without
------------------	---------

PCB Mount Alignment	Without
---------------------	---------

PCB Mount Retention	Without
---------------------	---------

Housing Features

Housing Material	Polyester - GF
------------------	----------------

Centerline (Pitch)	2.54 mm[.1 in]
--------------------	----------------

Dimensions



Connector Length	12.7 mm[.5 in]
------------------	----------------

PCB Thickness (Recommended)	1.6 mm[.063 in]
-----------------------------	-----------------

Usage Conditions

Operating Temperature Range	-55 – 105 °C[-67 – 221 °F]
-----------------------------	----------------------------

Operation/Application

Circuit Application	Signal
---------------------	--------

Industry Standards

Agency/Standard	CSA, UL
-----------------	---------

Approved Standards	CSA LR7189, UL E28476
--------------------	-----------------------

UL Flammability Rating	UL 94V-0
------------------------	----------

Packaging Features

Packaging Quantity	1
--------------------	---

Packaging Type	Package
----------------	---------

Product Compliance

[For compliance documentation, visit the product page on TE.com>](#)

EU RoHS Directive 2011/65/EU	Compliant
------------------------------	-----------

EU ELV Directive 2000/53/EC	Compliant
-----------------------------	-----------

China RoHS 2 Directive MIIT Order No 32, 2016	No Restricted Materials Above Threshold
---	---

EU REACH Regulation (EC) No. 1907/2006	Current ECHA Candidate List: JUNE 2023 (235) Candidate List Declared Against: JAN 2023 (233) Does not contain REACH SVHC
--	--

Halogen Content	Not Low Halogen - contains Br or Cl > 900 ppm.
-----------------	--

Solder Process Capability	Wave solder capable to 265°C
---------------------------	------------------------------

Product Compliance Disclaimer

This information is provided based on reasonable inquiry of our suppliers and represents our current actual knowledge based on the information they provided. This information is subject to change. The part numbers that TE has identified as EU RoHS compliant have a maximum concentration of 0.1% by weight in homogenous materials for lead, hexavalent chromium, mercury, PBB, PBDE, DBP, BBP, DEHP, DIBP, and 0.01% for cadmium, or qualify for an exemption to these limits as defined in the Annexes of Directive 2011/65/EU (RoHS2). Finished electrical and electronic equipment products will be CE marked as required by Directive 2011/65/EU. Components may not be CE marked. Additionally, the part numbers that TE has identified as EU ELV compliant have a maximum concentration of 0.1% by weight in homogenous materials for lead, hexavalent chromium, and mercury, and 0.01% for cadmium, or qualify for an exemption to these limits as defined in the Annexes of Directive 2000/53/EC (ELV). Regarding the REACH Regulation, the information TE provides

on SVHC in articles for this part number is based on the latest European Chemicals Agency (ECHA) 'Guidance on requirements for substances in articles' posted at this URL: <https://echa.europa.eu/guidance-documents/guidance-on-reach>

Compatible Parts



TE Part # CAT-104MTA-NGPMR
Nylon Gold Plated Receptacle: 2.54 mm, with Mating Alignment, MTA 100



TE Part # CAT-104MTA-NYLCC
Nylon PCB Connector Covers: 2.54 mm, MTA 100



TE Part # 1375820-4
CST-100 II HOUSING 4 POS



TE Part # CAT-104MTA-PLSCC
Polyester PCB Connector Covers: 2.54 mm, MTA 100



TE Part # CAT-104MTA-NGPNR
Nylon Gold Plated Receptacle: 2.54 mm, no Mating Alignment

Also in the Series | MTA 100



Insertion & Extraction Tools(2)



PCB Connector Covers(69)



PCB Connector Keying(1)



PCB Headers & Receptacles(451)



Standard Rectangular Connectors(497)



Wire-to-Board Connector Assemblies & Housings(1)



Wire-to-Board Connector Contacts(8)

Customers Also Bought

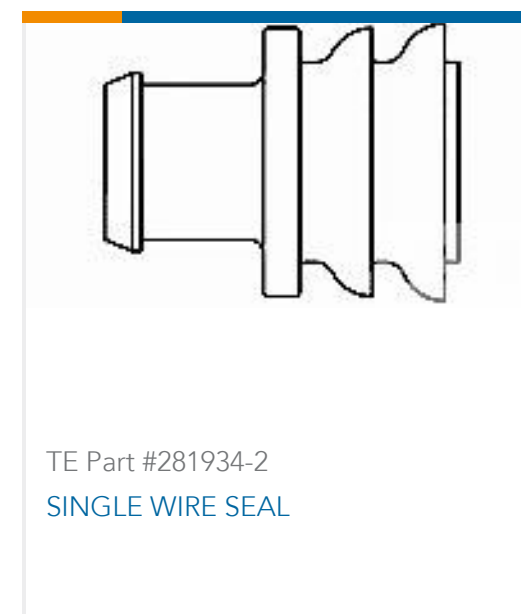
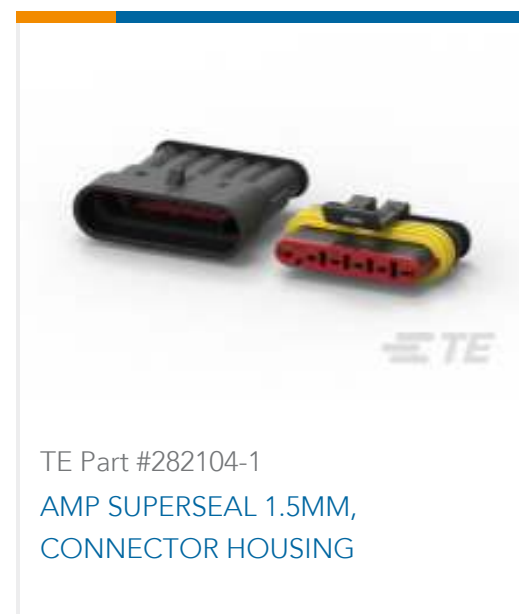
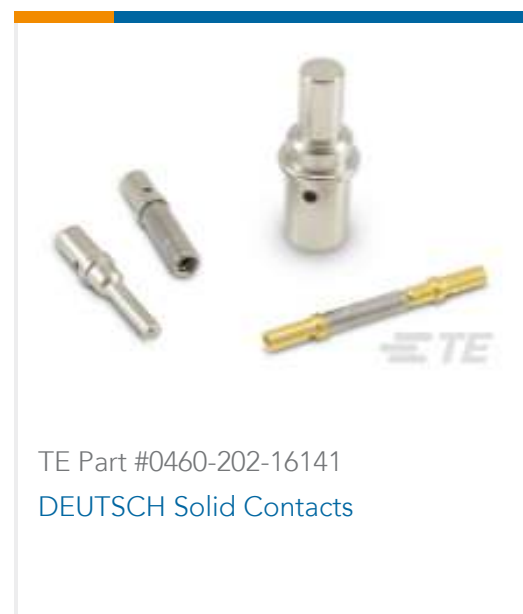

Documents

Product Drawings

[04P MTA100 HDR ASSY PL RA LF](#)

English

CAD Files

[3D PDF](#)

3D

Customer View Model

[ENG_CVM_CVM_3-641212-4_Y.2d_dxf.zip](#)

English

Customer View Model

[ENG_CVM_CVM_3-641212-4_Y.3d_igs.zip](#)

English

Customer View Model

[ENG_CVM_CVM_3-641212-4_Y.3d_stp.zip](#)

English

By downloading the CAD file I accept and agree to the [Terms and Conditions](#) of use.

Product Specifications

[Application Specification](#)

English

Agency Approvals

[Agency Approval Document](#)

English