

# **Switch Controlled Direct Drive Switch for Offline LED Drivers**

The TPS92411EVM-001 evaluation module (EVM) helps designers evaluate the operation and performance of the TPS92411P direct drive switch designed for use with a linear regulator in offline LED drive applications. The TPS92411P is designed to control the drive of high-brightness light emitting diodes (LEDs) and features a wide input voltage range (7.5 V to 100 V) and overvoltage protection.

### **Contents**

1	Description .....	2
	1.1 Typical Applications .....	2
	1.2 Features .....	2
2	Warnings and Cautions .....	2
3	Electrical Performance Specifications .....	3
4	Schematic .....	4
5	Performance Data and Typical Characteristic Curves .....	5
	5.1 Power Factor .....	5
	5.2 Line Regulation .....	5
	5.3 Input Voltage and Input Current .....	6
	5.4 Linear Regulator Drain Voltage and Input Current .....	6
	5.5 Triac Dimming Waveforms .....	7
	5.6 EMI Performance .....	10
6	TPS92411EVM-001 PCB layout .....	11
7	Bill of Materials .....	12

### **List of Figures**

1	TPS92411EVM-001 Schematic .....	4
2	Power Factor Versus Input Voltage .....	5
3	Input (Linear Regulator) Current Versus Input Voltage .....	5
4	Input Voltage (Top) and Input Current (Bottom) .....	6
5	Drain Voltage (Top) and Input Current (Bottom) .....	6
6	Forward Phase Triac Dimming: Input Voltage (Top) and Input Current (Bottom) .....	7
7	Forward Phase Triac Dimming: Input Voltage (Top) and Input Current (Bottom) .....	7
8	Forward Phase Triac Dimming: Input Voltage (Top) and Input Current (Bottom) .....	8
9	Reverse Phase Triac Dimming: Input Voltage (Top) and Input Current (Bottom) .....	8
10	Reverse Phase Triac Dimming: Input Voltage (Top) and Input Current (Bottom) .....	9
11	Reverse Phase Triac Dimming: Input Voltage (Top) and Input Current (Bottom) .....	9
12	Conducted EMI Performance .....	10
13	Top Layer and Top Overlay (Top view) .....	11

### **List of Tables**

1	TPS92411EVM-001 Electrical Performance Specifications .....	3
2	TPS92411EVM-001 Components List .....	12

## 1 Description

The TPS92411EVM-001 provides a high-brightness LED driver based on the TPS92411P in conjunction with a discrete linear regulator. It is designed to operate with an input voltage in the range of 90 VAC to 135 VAC with a 120 VAC nominal input voltage. This input voltage range is typical for offline applications. The EVM is set up for a default input current of 95 mA for approximately 12-W total power and 3 LED voltage stacks of 20 V, 40 V, and 80 V. The TPS92411 helps provide high efficacy, good power factor, low THD, and flicker free dimming.

### 1.1 Typical Applications

This converter design describes an application of the TPS92411P as an LED driver controller with the specifications listed below. For applications with a different input voltage range or different output voltage range refer to the TPS92411 data sheet ([SLUSBQ6](#)).

### 1.2 Features

#### 1.2.1 Connector Description

This section describes the connectors and test points on the EVM and how to properly connect, setup, and use the TPS92411EVM-001.

##### 1.2.1.1 J1

The screw down connector J1 is for the input voltage supply to the LED driver. The leads to the input supply should be twisted and kept as short as possible to minimize voltage drop, inductance, and EMI transmission. The input is not polarized, Line and Neutral may be connected to either terminal.

## 2 Warnings and Cautions

Observe the following precaution when using the TPS92411EVM-001.

**CAUTION**



**DO NOT STARE DIRECTLY INTO THE LED LIGHT SOURCE.**

Intense light sources have a high secondary blinding effect. A temporary reduction in visual acuity and afterimages can occur, leading to irritation, annoyance, visual impairment, and even accidents – depending on the situation. Always consider the use of light filtering and darkening protective eyewear and be fully aware of surrounding laboratory type set-ups when viewing intense light sources to minimize or eliminate such risks in order to avoid accidents related to temporary blindness.

### 3 Electrical Performance Specifications

**Table 1. TPS92411EVM-001 Electrical Performance Specifications**

PARAMETER	TEST CONDITIONS	MIN	TYP	MAX	UNITS
<b>INPUT CHARACTERISTICS</b>					
Voltage range		90	120	135	VAC
Maximum input current			95	105	mA
<b>OUTPUT CHARACTERISTICS</b>					
Output voltage, VOUT	Upper LED stack		80		V
	Middle LED stack		40		
	Lower LED stack		20		
Flicker Index			0.09		
Output current ripple percent			36%		
Output current ripple	Each stack		65		mApp
Overvoltage protection level	Each individual TPS92411P		100		V
<b>SYSTEMS CHARACTERISTICS</b>					
Efficiency	Input voltage = 120 Vac, No triac dimmer		83%		
Power Factor	Input voltage = 120 Vac, No triac dimmer		0.97		
THD	Input voltage = 120 Vac, No triac dimmer		14.9%		

4 Schematic

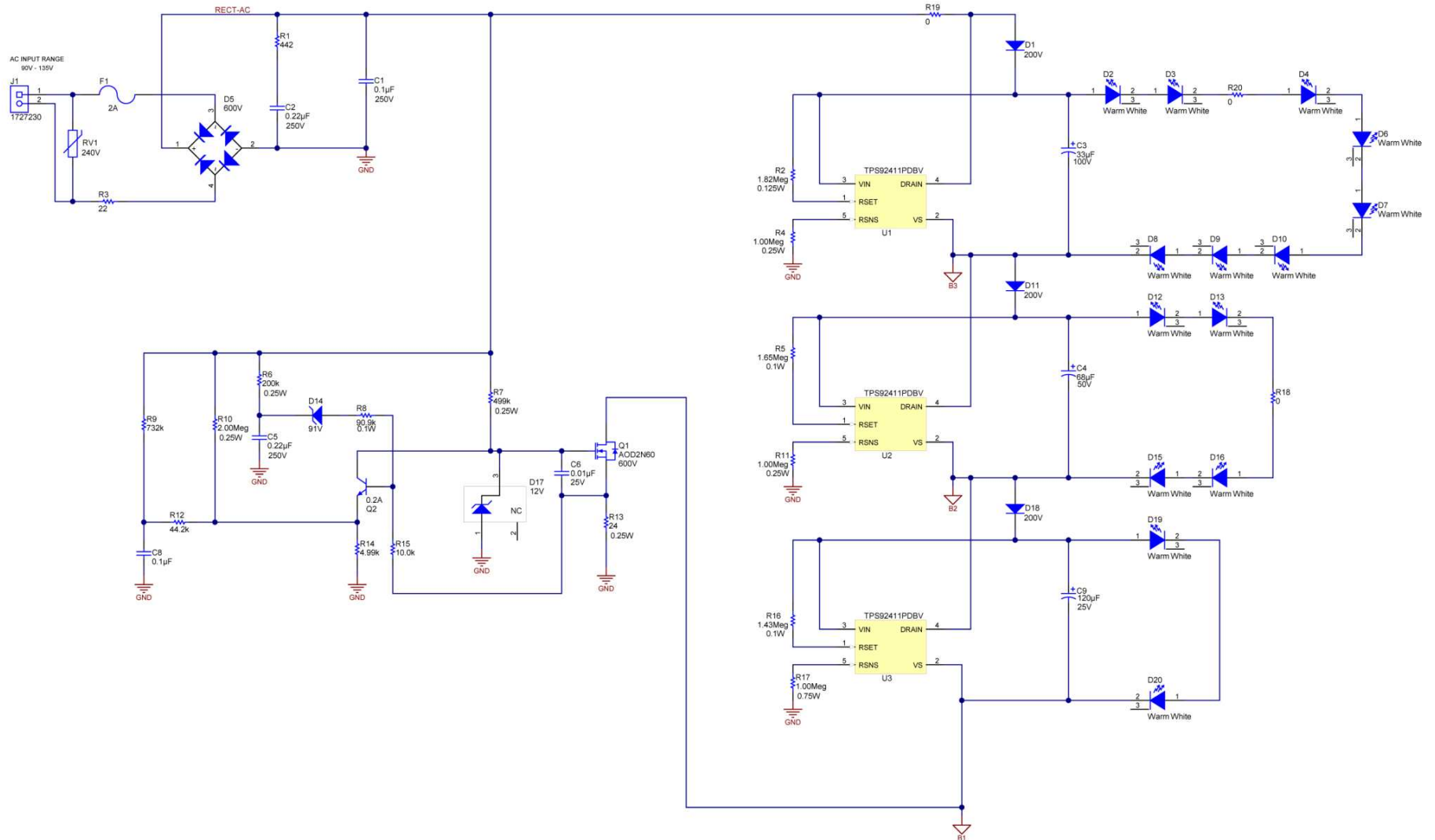

Figure 1. TPS92411EVM-001 Schematic

## 5 Performance Data and Typical Characteristic Curves

Figure 2 through Figure 12 present typical performance curves for TPS92411EVM-001.

### 5.1 Power Factor

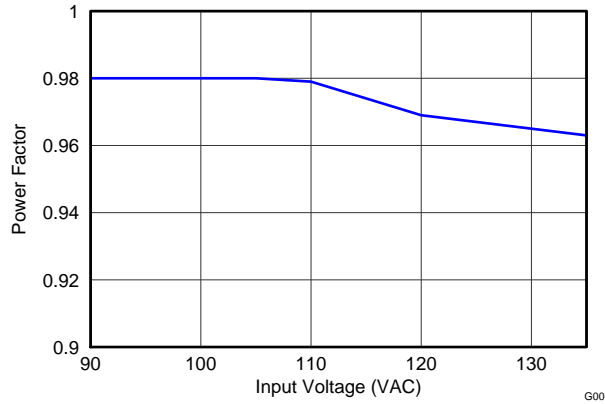

Figure 2. Power Factor Versus Input Voltage

### 5.2 Line Regulation

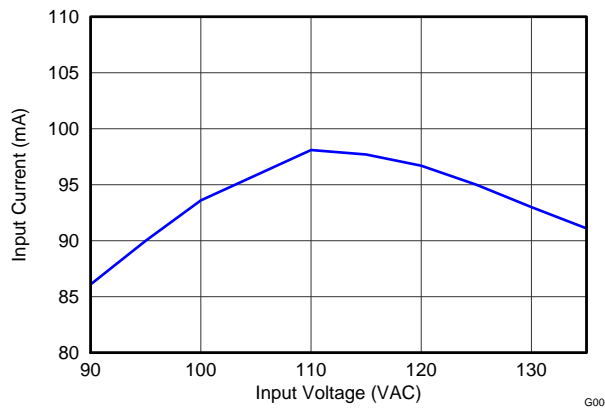

Figure 3. Input (Linear Regulator) Current Versus Input Voltage

### 5.3 Input Voltage and Input Current



Figure 4. Input Voltage (Top) and Input Current (Bottom)

### 5.4 Linear Regulator Drain Voltage and Input Current

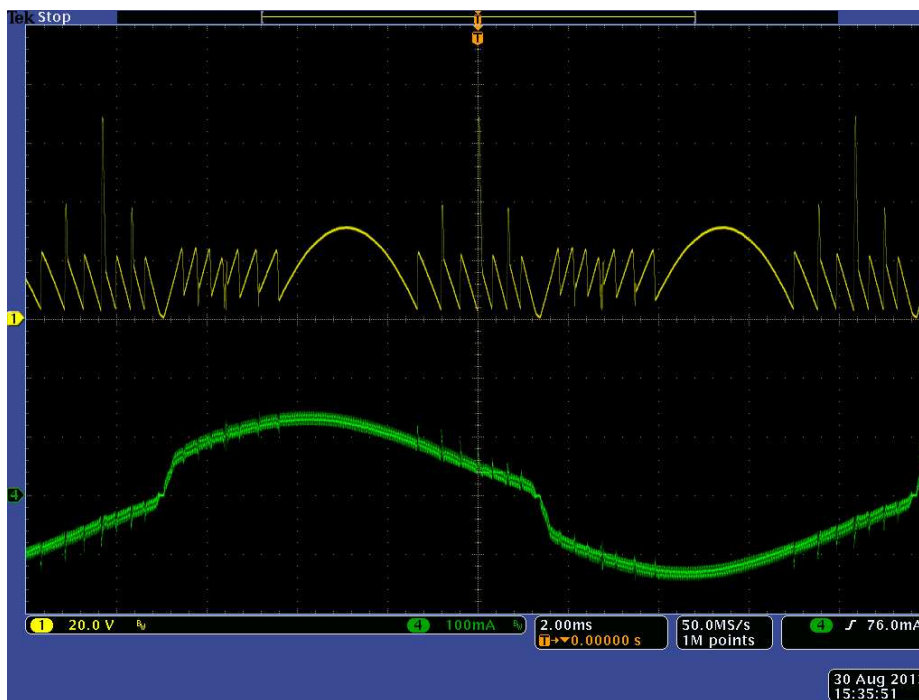

Figure 5. Drain Voltage (Top) and Input Current (Bottom)

### 5.5 Triac Dimming Waveforms

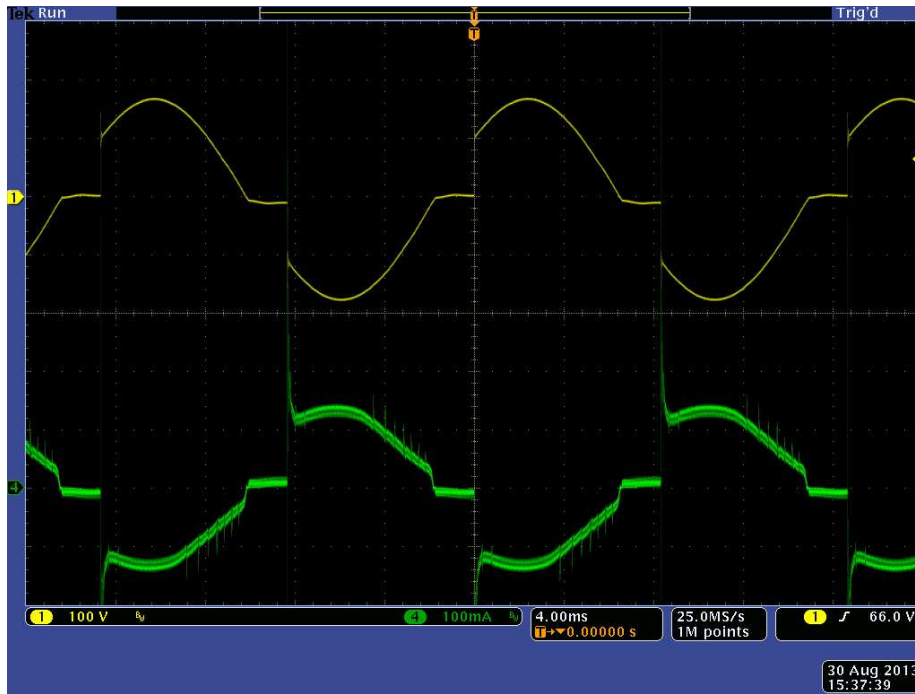

Figure 6. Forward Phase Triac Dimming: Input Voltage (Top) and Input Current (Bottom)

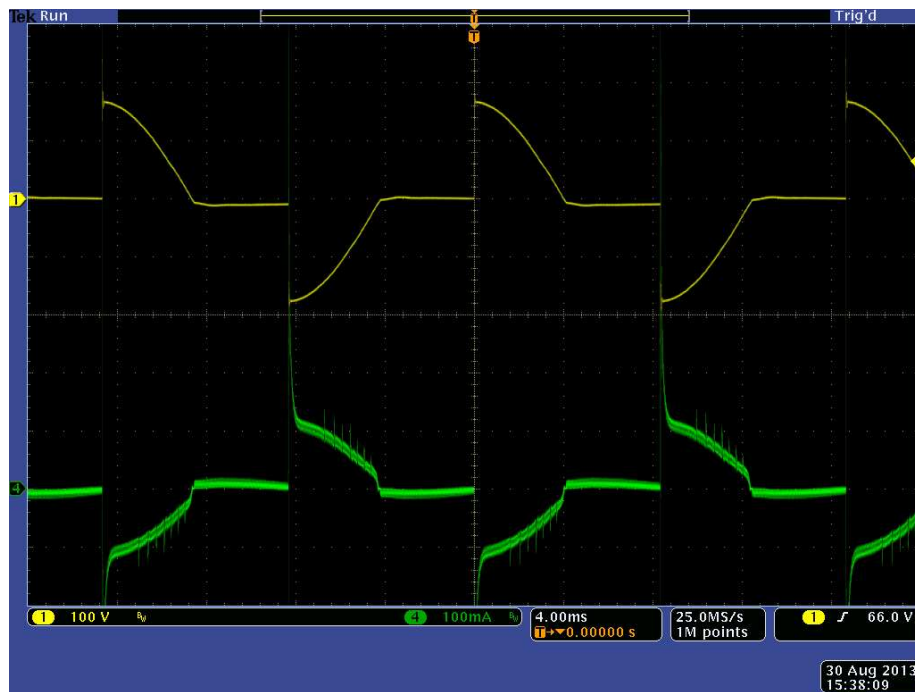

Figure 7. Forward Phase Triac Dimming: Input Voltage (Top) and Input Current (Bottom)

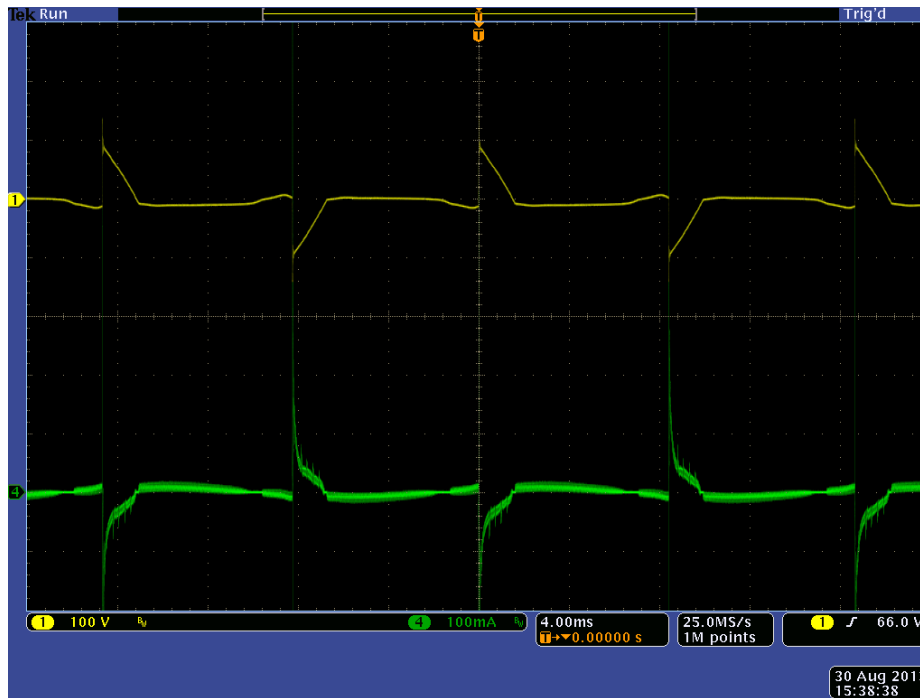

Figure 8. Forward Phase Triac Dimming: Input Voltage (Top) and Input Current (Bottom)

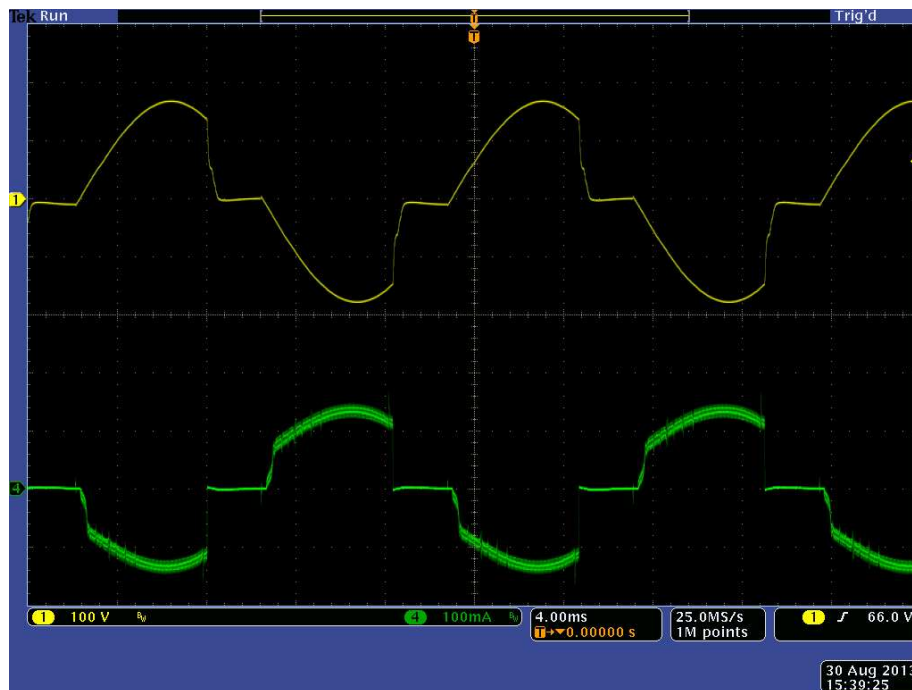

Figure 9. Reverse Phase Triac Dimming: Input Voltage (Top) and Input Current (Bottom)



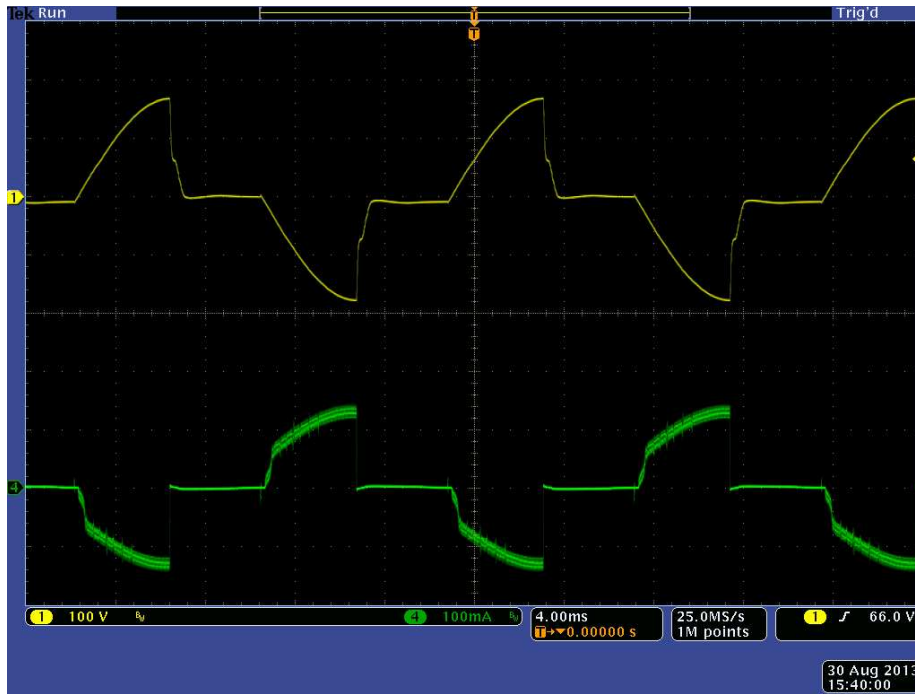

Figure 10. Reverse Phase Triac Dimming: Input Voltage (Top) and Input Current (Bottom)

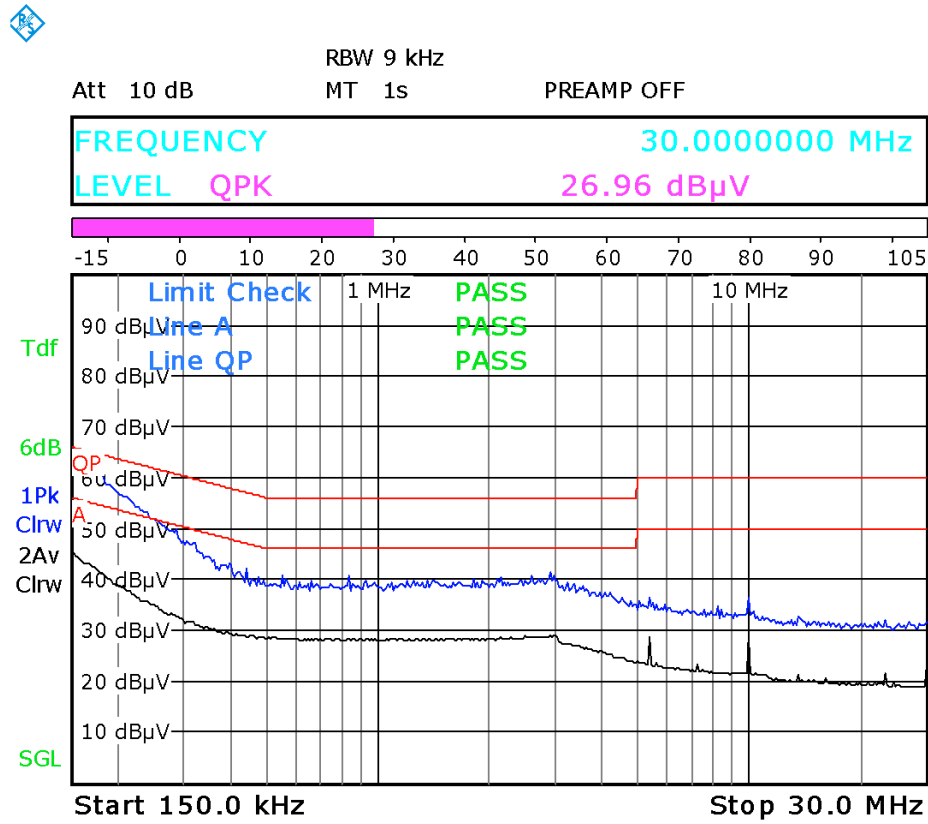

Figure 11. Reverse Phase Triac Dimming: Input Voltage (Top) and Input Current (Bottom)

### 5.6 EMI Performance

Figure 12 shows the conducted EMI performance of the EVM under the following conditions:

- $P_{IN} = 12\text{ W}$
- $V_{IN} = 120\text{ Vac}$
- “QP” = quasi-peak limit line
- “A” = average limit line
- Blue trace = peak scan
- Black trace = average scan



Date: 28.AUG.2013 04:32:47

Figure 12. Conducted EMI Performance

## 6 TPS92411EVM-001 PCB layout

Figure 13 shows the design of the TPS92411EVM-001 metal clad printed-circuit board

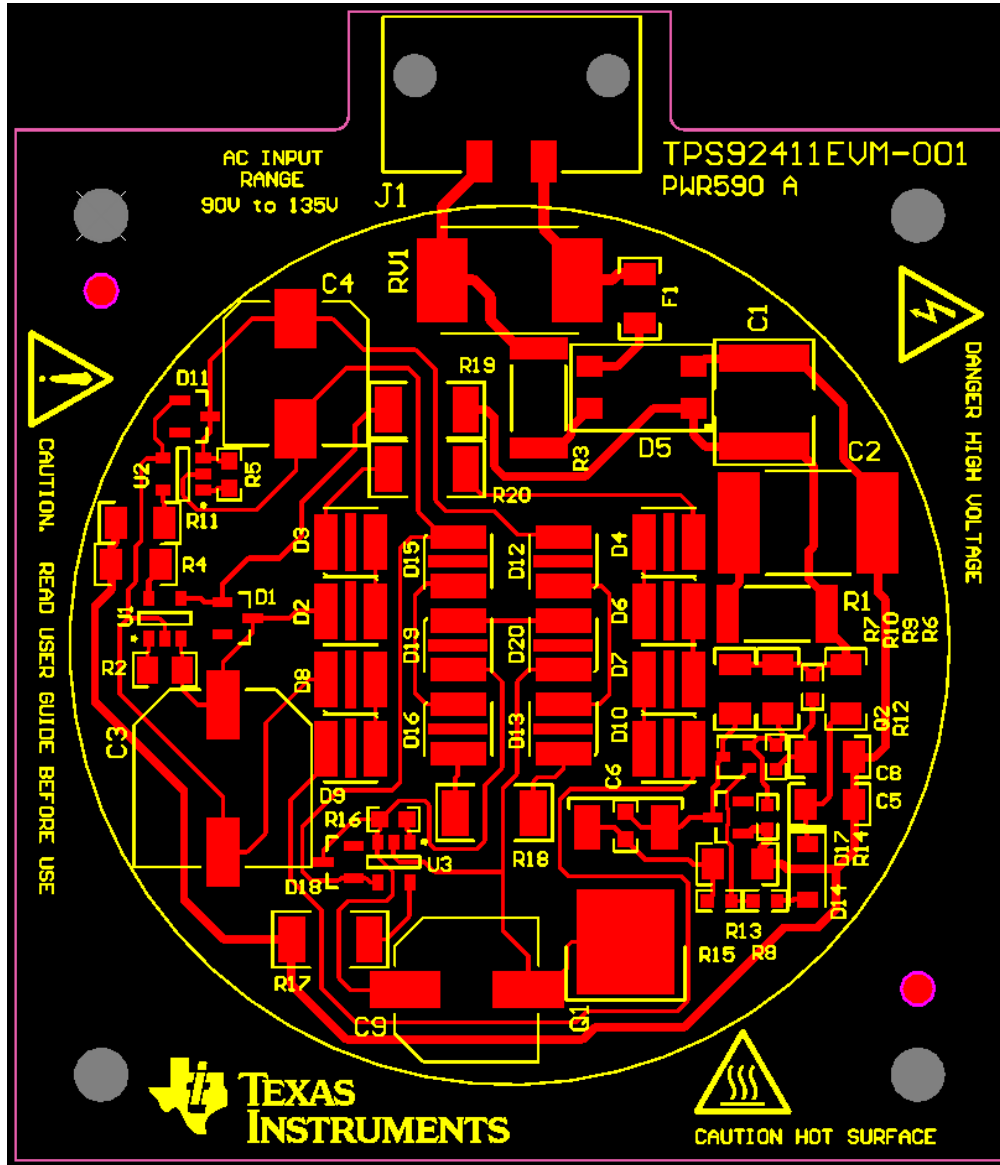

Figure 13. Top Layer and Top Overlay (Top view)

## 7 Bill of Materials

The bill of materials table for TPS92411EVM-001 contains the components list according to the schematic shown in [Figure 1](#).

**Table 2. TPS92411EVM-001 Components List**

REF DES	QTY	Value	Description	Size	Part Number	MFR
C1	1	0.1µF	CAP, CERM, 0.1uF, 250VDC, 2220	2220 (5750 Metric)	LDEID3100KA0N00	Kemet
C2	1	0.22µF	CAP, Film, 0.22uF, 250VDC, 2824	2824	CB052G0224JBC	AVX
C3	1	33uF	CAP, AL, 33uF, 100V, ±20%, 0.7 ohm, SMD	SMT Radial G	EEE-FK2A330P	Panasonic
C4	1	68uF	CAP, AL, 68uF, 50V, ±20%, 0.34 ohm, SMD	8x10	UUD1H680MNL1GS	Nichicon
C5	1	0.22µF	CAP, CERM, 0.22uF, 250V, X7T, 10%, 1206	1206	CGA5L3X7T2E224K160AE	TDK
C6	1	0.01uF	CAP, CERM, 0.01uF, 25V, ±5%, C0G/NP0, 0603	0603	C1608C0G1E103J	TDK
C8	1	0.1uF	CAP, CERM, 0.1uF, 100V, ±5%, X7R, 1206	1206	12061C104JAT2A	AVX
C9	1	120µF	CAP, Alum, 120uF, 25V, ±20%, SMD	Radial, Can - SMD	PCV1E121MCL6GS	Nichicon
D1, D11, D18	3	200V	Diode, P-N, 200V, 200A, SOT-23	SOT-23	BAS21-TP	Micro Commercial Components
D2–D10, D12, D13, D15, D16, D19, D20	14	XLamp ML-E	LED, SMT, Neutral White, XLamp ML-E	2-SMD, Gull Wing Tabs	MLESWT-A1-0000-0002E7	Cree Inc
D5	1		Diode, Switching-Bridge, 600V, 0.8A, MiniDIP	MiniDIP	HD06-T	Diodes Inc.
D14	1		Diode, Zener, 91V, 500mW, SOD-123	SOD-123	MMSZ5270BT1G	ON Semiconductor
D17	1	12V	Diode, Zener, 12V, 225mW, SOT-23	SOT-23	MMBZ5242BLT1G	ON Semiconductor
F1	1		Fuse, 2A, 125V, 1206	1206	C1Q 2	Bel Fuse Inc
H3	1		HEATSINK DC/DC HALF BRICK VERT		518-95AB	Wakefield Thermal Solutions
J1	1		Header, Term Blk, 2Pos, 3.81mm, SMD	Header, 2mm, 2x1	1727230	Phoenix Contact
Q1	1		MOSFET, N-CH, 600V, 2A, DPAK	TO-252-3, DPak (2 Leads + Tab), SC-63	AOD2N60	Alpha & Omega Semiconductor Inc
Q2	1	Value	Transistor, NPN, 40V, 200mW, SOT-323	SC-70, SOT-323	MMST3904-7-F	Diodes Inc
R1	1	442	RES, 442 ohm, 1%, 1W, 2512	2512 (6432 Metric)	CRCW2512442RFKEG	Vishay Dale
R2	1	1.82Meg	RES, 1.82Meg ohm, 1%, 0.125W, 0805	0805	CRCW08051M82FKEA	Vishay-Dale
R3	1	22	RES, 22 ohm, 5%, 1.5W, 2512	2512 (6432 Metric)	CRCW251222R0JNEGHP	Vishay Dale
R4, R11	2	1.00Meg	RES, 1.00Meg ohm, 1%, 0.25W, 1206	1206	CRCW12061M00FKEA	Vishay-Dale
R5	1	1.65Meg	RES, 1.65Meg ohm, 1%, 0.1W, 0603	0603	CRCW06031M65FKEA	Vishay-Dale
R6	1	200k	RES, 200k ohm, 1%, 0.25W, 1206	1206	CRCW1206200KFKEA	Vishay-Dale
R7	1	499k	RES, 499k ohm, 1%, 0.25W, 1206	1206	CRCW1206499KFKEA	Vishay-Dale
R8	1	90.9k	RES, 90.9k ohm, 1%, 0.1W, 0603	0603	CRCW060390K9FKEA	Vishay-Dale
R9	1	732k	RES, 732k ohm, 1%, 0.1W, 0603	0603	CRCW0603732KFKEA	Vishay-Dale
R10	1	2.00Meg	RES, 2.00Meg ohm, 1%, 0.25W, 1206	1206	CRCW12062M00FKEA	Vishay-Dale
R12	1	44.2k	RES, 44.2k ohm, 1%, 0.1W, 0603	0603	CRCW060344K2FKEA	Vishay-Dale
R13	1	24	RES, 24 ohm, 5%, 0.25W, 1206	1206	CRCW120624R0JNEA	Vishay-Dale
R14	1	4.99k	RES, 4.99k ohm, 1%, 0.1W, 0603	0603	CRCW06034K99FKEA	Vishay-Dale
R15	1	10.0k	RES, 10.0k ohm, 1%, 0.1W, 0603	0603	CRCW060310K0FKEA	Vishay-Dale
R16	1	1.43Meg	RES, 1.43Meg ohm, 1%, 0.1W, 0603	0603	CRCW06031M43FKEA	Vishay-Dale
R17	1	1M	RES, 1M ohm, 1%, 0.75W, 2010	2010 (5025 Metric)	CRCW20101M00FKEF	Vishay Dale
R18, R19, R20	3	0	RES, 0 ohm, 0.75W, 2010	2010 (5025 Metric)	CRCW20100000Z0EF	Vishay Dale
RV1	1		Varistor, 150VAC, 200VDC, 9J, 3225	3225 (8063 Metric)	PV150K3225T	Stackpole Electronics Inc
U1, U2, U3	3		IC, TPS92411 with OVP	SOT23-5	TPS92411PDBV	Texas Instrumenmts

---

## Revision History

<b>Changes from Original (October 2013) to A Revision</b>	<b>Page</b>
---	-------------

---

- Added section 2, Warnings and Cautions. .... [2](#)
- 

NOTE: Page numbers for previous revisions may differ from page numbers in the current version.

## EVALUATION BOARD/KIT/MODULE (EVM) ADDITIONAL TERMS

Texas Instruments (TI) provides the enclosed Evaluation Board/Kit/Module (EVM) under the following conditions:

The user assumes all responsibility and liability for proper and safe handling of the goods. Further, the user indemnifies TI from all claims arising from the handling or use of the goods.

Should this evaluation board/kit not meet the specifications indicated in the User's Guide, the board/kit may be returned within 30 days from the date of delivery for a full refund. THE FOREGOING LIMITED WARRANTY IS THE EXCLUSIVE WARRANTY MADE BY SELLER TO BUYER AND IS IN LIEU OF ALL OTHER WARRANTIES, EXPRESSED, IMPLIED, OR STATUTORY, INCLUDING ANY WARRANTY OF MERCHANTABILITY OR FITNESS FOR ANY PARTICULAR PURPOSE. EXCEPT TO THE EXTENT OF THE INDEMNITY SET FORTH ABOVE, NEITHER PARTY SHALL BE LIABLE TO THE OTHER FOR ANY INDIRECT, SPECIAL, INCIDENTAL, OR CONSEQUENTIAL DAMAGES.

Please read the User's Guide and, specifically, the Warnings and Restrictions notice in the User's Guide prior to handling the product. This notice contains important safety information about temperatures and voltages. For additional information on TI's environmental and/or safety programs, please visit [www.ti.com/esh](http://www.ti.com/esh) or contact TI.

No license is granted under any patent right or other intellectual property right of TI covering or relating to any machine, process, or combination in which such TI products or services might be or are used. TI currently deals with a variety of customers for products, and therefore our arrangement with the user is not exclusive. TI assumes no liability for applications assistance, customer product design, software performance, or infringement of patents or services described herein.

## REGULATORY COMPLIANCE INFORMATION

As noted in the EVM User's Guide and/or EVM itself, this EVM and/or accompanying hardware may or may not be subject to the Federal Communications Commission (FCC) and Industry Canada (IC) rules.

For EVMs **not** subject to the above rules, this evaluation board/kit/module is intended for use for ENGINEERING DEVELOPMENT, DEMONSTRATION OR EVALUATION PURPOSES ONLY and is not considered by TI to be a finished end product fit for general consumer use. It generates, uses, and can radiate radio frequency energy and has not been tested for compliance with the limits of computing devices pursuant to part 15 of FCC or ICES-003 rules, which are designed to provide reasonable protection against radio frequency interference. Operation of the equipment may cause interference with radio communications, in which case the user at his own expense will be required to take whatever measures may be required to correct this interference.

### General Statement for EVMs including a radio

*User Power/Frequency Use Obligations:* This radio is intended for development/professional use only in legally allocated frequency and power limits. Any use of radio frequencies and/or power availability of this EVM and its development application(s) must comply with local laws governing radio spectrum allocation and power limits for this evaluation module. It is the user's sole responsibility to only operate this radio in legally acceptable frequency space and within legally mandated power limitations. Any exceptions to this are strictly prohibited and unauthorized by Texas Instruments unless user has obtained appropriate experimental/development licenses from local regulatory authorities, which is responsibility of user including its acceptable authorization.

### For EVMs annotated as FCC – FEDERAL COMMUNICATIONS COMMISSION Part 15 Compliant

#### Caution

This device complies with part 15 of the FCC Rules. Operation is subject to the following two conditions: (1) This device may not cause harmful interference, and (2) this device must accept any interference received, including interference that may cause undesired operation.

Changes or modifications not expressly approved by the party responsible for compliance could void the user's authority to operate the equipment.

### FCC Interference Statement for Class A EVM devices

This equipment has been tested and found to comply with the limits for a Class A digital device, pursuant to part 15 of the FCC Rules. These limits are designed to provide reasonable protection against harmful interference when the equipment is operated in a commercial environment. This equipment generates, uses, and can radiate radio frequency energy and, if not installed and used in accordance with the instruction manual, may cause harmful interference to radio communications. Operation of this equipment in a residential area is likely to cause harmful interference in which case the user will be required to correct the interference at his own expense.

### **FCC Interference Statement for Class B EVM devices**

This equipment has been tested and found to comply with the limits for a Class B digital device, pursuant to part 15 of the FCC Rules. These limits are designed to provide reasonable protection against harmful interference in a residential installation. This equipment generates, uses and can radiate radio frequency energy and, if not installed and used in accordance with the instructions, may cause harmful interference to radio communications. However, there is no guarantee that interference will not occur in a particular installation. If this equipment does cause harmful interference to radio or television reception, which can be determined by turning the equipment off and on, the user is encouraged to try to correct the interference by one or more of the following measures:

- Reorient or relocate the receiving antenna.
- Increase the separation between the equipment and receiver.
- Connect the equipment into an outlet on a circuit different from that to which the receiver is connected.
- Consult the dealer or an experienced radio/TV technician for help.

### **For EVMs annotated as IC – INDUSTRY CANADA Compliant**

This Class A or B digital apparatus complies with Canadian ICES-003.

Changes or modifications not expressly approved by the party responsible for compliance could void the user's authority to operate the equipment.

### **Concerning EVMs including radio transmitters**

This device complies with Industry Canada licence-exempt RSS standard(s). Operation is subject to the following two conditions: (1) this device may not cause interference, and (2) this device must accept any interference, including interference that may cause undesired operation of the device.

### **Concerning EVMs including detachable antennas**

Under Industry Canada regulations, this radio transmitter may only operate using an antenna of a type and maximum (or lesser) gain approved for the transmitter by Industry Canada. To reduce potential radio interference to other users, the antenna type and its gain should be so chosen that the equivalent isotropically radiated power (e.i.r.p.) is not more than that necessary for successful communication.

This radio transmitter has been approved by Industry Canada to operate with the antenna types listed in the user guide with the maximum permissible gain and required antenna impedance for each antenna type indicated. Antenna types not included in this list, having a gain greater than the maximum gain indicated for that type, are strictly prohibited for use with this device.

Cet appareil numérique de la classe A ou B est conforme à la norme NMB-003 du Canada.

Les changements ou les modifications pas expressément approuvés par la partie responsable de la conformité ont pu vider l'autorité de l'utilisateur pour actionner l'équipement.

### **Concernant les EVMs avec appareils radio**

Le présent appareil est conforme aux CNR d'Industrie Canada applicables aux appareils radio exempts de licence. L'exploitation est autorisée aux deux conditions suivantes : (1) l'appareil ne doit pas produire de brouillage, et (2) l'utilisateur de l'appareil doit accepter tout brouillage radioélectrique subi, même si le brouillage est susceptible d'en compromettre le fonctionnement.

### **Concernant les EVMs avec antennes détachables**

Conformément à la réglementation d'Industrie Canada, le présent émetteur radio peut fonctionner avec une antenne d'un type et d'un gain maximal (ou inférieur) approuvé pour l'émetteur par Industrie Canada. Dans le but de réduire les risques de brouillage radioélectrique à l'intention des autres utilisateurs, il faut choisir le type d'antenne et son gain de sorte que la puissance isotrope rayonnée équivalente (p.i.r.e.) ne dépasse pas l'intensité nécessaire à l'établissement d'une communication satisfaisante.

Le présent émetteur radio a été approuvé par Industrie Canada pour fonctionner avec les types d'antenne énumérés dans le manuel d'usage et ayant un gain admissible maximal et l'impédance requise pour chaque type d'antenne. Les types d'antenne non inclus dans cette liste, ou dont le gain est supérieur au gain maximal indiqué, sont strictement interdits pour l'exploitation de l'émetteur.

## **【Important Notice for Users of EVMs for RF Products in Japan】**

**This development kit is NOT certified as Confirming to Technical Regulations of Radio Law of Japan**

If you use this product in Japan, you are required by Radio Law of Japan to follow the instructions below with respect to this product:

1. Use this product in a shielded room or any other test facility as defined in the notification #173 issued by Ministry of Internal Affairs and Communications on March 28, 2006, based on Sub-section 1.1 of Article 6 of the Ministry's Rule for Enforcement of Radio Law of Japan,
2. Use this product only after you obtained the license of Test Radio Station as provided in Radio Law of Japan with respect to this product, or
3. Use of this product only after you obtained the Technical Regulations Conformity Certification as provided in Radio Law of Japan with respect to this product. Also, please do not transfer this product, unless you give the same notice above to the transferee. Please note that if you could not follow the instructions above, you will be subject to penalties of Radio Law of Japan.

**Texas Instruments Japan Limited**  
**(address) 24-1, Nishi-Shinjuku 6 chome, Shinjuku-ku, Tokyo, Japan**

<http://www.tij.co.jp>

### **【無線電波を送信する製品の開発キットをお使いになる際の注意事項】**

本開発キットは技術基準適合証明を受けておりません。

本製品のご使用に際しては、電波法遵守のため、以下のいずれかの措置を取っていただく必要がありますのでご注意ください。

1. 電波法施行規則第6条第1項第1号に基づく平成18年3月28日総務省告示第173号で定められた電波暗室等の試験設備でご使用いただく。
2. 実験局の免許を取得後ご使用いただく。
3. 技術基準適合証明を取得後ご使用いただく。

なお、本製品は、上記の「ご使用にあたっての注意」を譲渡先、移転先に通知しない限り、譲渡、移転できないものとします。

上記を遵守頂けない場合は、電波法の罰則が適用される可能性があることをご留意ください。

日本テキサス・インスツルメンツ株式会社  
東京都新宿区西新宿 6 丁目 2 4 番 1 号  
西新宿三井ビル

<http://www.tij.co.jp>



## **EVALUATION BOARD/KIT/MODULE (EVM) WARNINGS, RESTRICTIONS AND DISCLAIMERS**

**For Feasibility Evaluation Only, in Laboratory/Development Environments.** Unless otherwise indicated, this EVM is not a finished electrical equipment and not intended for consumer use. It is intended solely for use for preliminary feasibility evaluation in laboratory/development environments by technically qualified electronics experts who are familiar with the dangers and application risks associated with handling electrical mechanical components, systems and subsystems. It should not be used as all or part of a finished end product.

Your Sole Responsibility and Risk. You acknowledge, represent and agree that:

1. You have unique knowledge concerning Federal, State and local regulatory requirements (including but not limited to Food and Drug Administration regulations, if applicable) which relate to your products and which relate to your use (and/or that of your employees, affiliates, contractors or designees) of the EVM for evaluation, testing and other purposes.
2. You have full and exclusive responsibility to assure the safety and compliance of your products with all such laws and other applicable regulatory requirements, and also to assure the safety of any activities to be conducted by you and/or your employees, affiliates, contractors or designees, using the EVM. Further, you are responsible to assure that any interfaces (electronic and/or mechanical) between the EVM and any human body are designed with suitable isolation and means to safely limit accessible leakage currents to minimize the risk of electrical shock hazard.
3. Since the EVM is not a completed product, it may not meet all applicable regulatory and safety compliance standards (such as UL, CSA, VDE, CE, RoHS and WEEE) which may normally be associated with similar items. You assume full responsibility to determine and/or assure compliance with any such standards and related certifications as may be applicable. You will employ reasonable safeguards to ensure that your use of the EVM will not result in any property damage, injury or death, even if the EVM should fail to perform as described or expected.
4. You will take care of proper disposal and recycling of the EVM's electronic components and packing materials.

**Certain Instructions.** It is important to operate this EVM within TI's recommended specifications and environmental considerations per the user guidelines. Exceeding the specified EVM ratings (including but not limited to input and output voltage, current, power, and environmental ranges) may cause property damage, personal injury or death. If there are questions concerning these ratings please contact a TI field representative prior to connecting interface electronics including input power and intended loads. Any loads applied outside of the specified output range may result in unintended and/or inaccurate operation and/or possible permanent damage to the EVM and/or interface electronics. Please consult the EVM User's Guide prior to connecting any load to the EVM output. If there is uncertainty as to the load specification, please contact a TI field representative. During normal operation, some circuit components may have case temperatures greater than 60°C as long as the input and output are maintained at a normal ambient operating temperature. These components include but are not limited to linear regulators, switching transistors, pass transistors, and current sense resistors which can be identified using the EVM schematic located in the EVM User's Guide. When placing measurement probes near these devices during normal operation, please be aware that these devices may be very warm to the touch. As with all electronic evaluation tools, only qualified personnel knowledgeable in electronic measurement and diagnostics normally found in development environments should use these EVMs.

**Agreement to Defend, Indemnify and Hold Harmless.** You agree to defend, indemnify and hold TI, its licensors and their representatives harmless from and against any and all claims, damages, losses, expenses, costs and liabilities (collectively, "Claims") arising out of or in connection with any use of the EVM that is not in accordance with the terms of the agreement. This obligation shall apply whether Claims arise under law of tort or contract or any other legal theory, and even if the EVM fails to perform as described or expected.

**Safety-Critical or Life-Critical Applications.** If you intend to evaluate the components for possible use in safety critical applications (such as life support) where a failure of the TI product would reasonably be expected to cause severe personal injury or death, such as devices which are classified as FDA Class III or similar classification, then you must specifically notify TI of such intent and enter into a separate Assurance and Indemnity Agreement.

Mailing Address: Texas Instruments, Post Office Box 655303, Dallas, Texas 75265  
Copyright © 2013, Texas Instruments Incorporated

## IMPORTANT NOTICE

Texas Instruments Incorporated and its subsidiaries (TI) reserve the right to make corrections, enhancements, improvements and other changes to its semiconductor products and services per JESD46, latest issue, and to discontinue any product or service per JESD48, latest issue. Buyers should obtain the latest relevant information before placing orders and should verify that such information is current and complete. All semiconductor products (also referred to herein as "components") are sold subject to TI's terms and conditions of sale supplied at the time of order acknowledgment.

TI warrants performance of its components to the specifications applicable at the time of sale, in accordance with the warranty in TI's terms and conditions of sale of semiconductor products. Testing and other quality control techniques are used to the extent TI deems necessary to support this warranty. Except where mandated by applicable law, testing of all parameters of each component is not necessarily performed.

TI assumes no liability for applications assistance or the design of Buyers' products. Buyers are responsible for their products and applications using TI components. To minimize the risks associated with Buyers' products and applications, Buyers should provide adequate design and operating safeguards.

TI does not warrant or represent that any license, either express or implied, is granted under any patent right, copyright, mask work right, or other intellectual property right relating to any combination, machine, or process in which TI components or services are used. Information published by TI regarding third-party products or services does not constitute a license to use such products or services or a warranty or endorsement thereof. Use of such information may require a license from a third party under the patents or other intellectual property of the third party, or a license from TI under the patents or other intellectual property of TI.

Reproduction of significant portions of TI information in TI data books or data sheets is permissible only if reproduction is without alteration and is accompanied by all associated warranties, conditions, limitations, and notices. TI is not responsible or liable for such altered documentation. Information of third parties may be subject to additional restrictions.

Resale of TI components or services with statements different from or beyond the parameters stated by TI for that component or service voids all express and any implied warranties for the associated TI component or service and is an unfair and deceptive business practice. TI is not responsible or liable for any such statements.

Buyer acknowledges and agrees that it is solely responsible for compliance with all legal, regulatory and safety-related requirements concerning its products, and any use of TI components in its applications, notwithstanding any applications-related information or support that may be provided by TI. Buyer represents and agrees that it has all the necessary expertise to create and implement safeguards which anticipate dangerous consequences of failures, monitor failures and their consequences, lessen the likelihood of failures that might cause harm and take appropriate remedial actions. Buyer will fully indemnify TI and its representatives against any damages arising out of the use of any TI components in safety-critical applications.

In some cases, TI components may be promoted specifically to facilitate safety-related applications. With such components, TI's goal is to help enable customers to design and create their own end-product solutions that meet applicable functional safety standards and requirements. Nonetheless, such components are subject to these terms.

No TI components are authorized for use in FDA Class III (or similar life-critical medical equipment) unless authorized officers of the parties have executed a special agreement specifically governing such use.

Only those TI components which TI has specifically designated as military grade or "enhanced plastic" are designed and intended for use in military/aerospace applications or environments. Buyer acknowledges and agrees that any military or aerospace use of TI components which have **not** been so designated is solely at the Buyer's risk, and that Buyer is solely responsible for compliance with all legal and regulatory requirements in connection with such use.

TI has specifically designated certain components as meeting ISO/TS16949 requirements, mainly for automotive use. In any case of use of non-designated products, TI will not be responsible for any failure to meet ISO/TS16949.

### Products

Audio	<a href="http://www.ti.com/audio">www.ti.com/audio</a>
Amplifiers	<a href="http://amplifier.ti.com">amplifier.ti.com</a>
Data Converters	<a href="http://dataconverter.ti.com">dataconverter.ti.com</a>
DLP® Products	<a href="http://www.dlp.com">www.dlp.com</a>
DSP	<a href="http://dsp.ti.com">dsp.ti.com</a>
Clocks and Timers	<a href="http://www.ti.com/clocks">www.ti.com/clocks</a>
Interface	<a href="http://interface.ti.com">interface.ti.com</a>
Logic	<a href="http://logic.ti.com">logic.ti.com</a>
Power Mgmt	<a href="http://power.ti.com">power.ti.com</a>
Microcontrollers	<a href="http://microcontroller.ti.com">microcontroller.ti.com</a>
RFID	<a href="http://www.ti-rfid.com">www.ti-rfid.com</a>
OMAP Applications Processors	<a href="http://www.ti.com/omap">www.ti.com/omap</a>
Wireless Connectivity	<a href="http://www.ti.com/wirelessconnectivity">www.ti.com/wirelessconnectivity</a>

### Applications

Automotive and Transportation	<a href="http://www.ti.com/automotive">www.ti.com/automotive</a>
Communications and Telecom	<a href="http://www.ti.com/communications">www.ti.com/communications</a>
Computers and Peripherals	<a href="http://www.ti.com/computers">www.ti.com/computers</a>
Consumer Electronics	<a href="http://www.ti.com/consumer-apps">www.ti.com/consumer-apps</a>
Energy and Lighting	<a href="http://www.ti.com/energy">www.ti.com/energy</a>
Industrial	<a href="http://www.ti.com/industrial">www.ti.com/industrial</a>
Medical	<a href="http://www.ti.com/medical">www.ti.com/medical</a>
Security	<a href="http://www.ti.com/security">www.ti.com/security</a>
Space, Avionics and Defense	<a href="http://www.ti.com/space-avionics-defense">www.ti.com/space-avionics-defense</a>
Video and Imaging	<a href="http://www.ti.com/video">www.ti.com/video</a>

### TI E2E Community

[e2e.ti.com](http://e2e.ti.com)