

MAXIM

MAX3669ETG Evaluation Kit

General Description

The MAX3669ETG evaluation kit (EV kit) is an assembled demonstration board that provides easy optical or electrical evaluation of the MAX3669ETG, a 622Mbps laser driver with current monitors and automatic power control (APC) circuitry. Although the MAX3669ETG EV kit is shipped in the electrical configuration, this EV kit also provides configuration instructions for optical operation.

Component Suppliers

SUPPLIER	PHONE	FAX
AVX	843-448-9411	843-448-1943
Coilcraft	847-639-6400	847-639-1469
Murata	770-436-1300	770-436-3030
Zetex	631-360-2222	631-360-8222

Note: Please indicate that you are using the MAX3669ETG when contacting these component suppliers.

Component List for Electrical Configuration

DESIGNATION	QTY	DESCRIPTION
C1, C2, C6, C12, C20	5	0.01 μ F \pm 10% ceramic capacitors (0402)
C4, C7, C10, C11	4	1 μ F \pm 10% ceramic capacitors (0603)
C5	1	Do not install
C8	1	100pF \pm 10% ceramic capacitor (0402)
C16	1	0.1 μ F \pm 10% ceramic capacitor (0603)
C19	1	10 μ F \pm 10%, 10V min tantalum capacitor, case B AVX TAJC106K016
C21	1	5pF \pm 5% ceramic capacitor (0402)
D1	1	LED
J1, J2, J3	3	SMA connectors, edge mount
L3	1	1.2 μ H inductor Coilcraft 1008LS-122XKBC
P1	1	2-pin header, 0.1in centers
None	1	Shunt for P1
Q1	1	PNP transistor Zetex FMMT591A
R1, R2, R24	3	1.5k Ω \pm 5% resistors (0402)
R3	1	1k Ω \pm 5% resistor (0603)
R5	1	12.4 Ω \pm 1% resistor (0402)

Features

- ◆ Fully Assembled and Tested
- ◆ +3.3V or +5V Operation
- ◆ On-Board Input Termination
- ◆ Independent Electrical Monitoring of Modulation and Bias Currents

Ordering Information

PART	TEMP RANGE	IC PACKAGE
MAX3669ETGEVKIT	-40°C to +85°C	24 QFN

Evaluates: MAX3669ETG

MAX3669ETG Evaluation Kit

Component Modifications for Optical Configuration

DESIGNATION	QTY	DESCRIPTION
J3	1	Remove
L2	1	Ferrite bead Murata BLM18HG601SN1
R5	1	Remove
R13	1	Remove
R19	1	20Ω ±5% resistor (0402)
R20	1	5Ω ±5% resistor (0402)
R22	1	Remove
R23	1	Remove
U2	1	User-supplied laser diode

Quick Start

Electrical Setup (Default)

In the electrical configuration, an APC test circuit is included to emulate a semiconductor laser with a monitor photodiode. Monitor diode current is provided by Q1, which is controlled by an operational amplifier (U3). The APC test circuit, consisting of U3 and Q1, applies the simulated monitor diode current to the MAX3669ETG's MD pin. The ratio of I_{BIAS} / I_{MD} is R₂₄ / R₂₃ = 100. To ensure proper operation in the electrical configuration, set up the evaluation board as follows:

- 1) Verify inductor L2 is not installed.
- 2) Remove the shunt from P1 to enable the output.

Note: When performing the following resistance checks, manually set the ohmmeter to a high range to avoid forward biasing the on-chip ESD protection diodes.

- 3) Adjust R14, the MOD (R_{MODSET}) potentiometer, for 10kΩ resistance between pins 2 and 3 (test point 5 and ground).
- 4) Adjust R15, the BIAS (R_{BIASMAX}) potentiometer, for 10kΩ resistance between pins 2 and 3 (test point 4 and ground).
- 5) Adjust R16, the APC (R_{APCSET}) potentiometer, for 10kΩ resistance between pins 2 and 3 (test point 6 and ground).
- 6) Power up the board with a +3.3V supply.
- 7) Apply a differential input signal (max amplitude ≤800mV per side) to J1 and J2 (DATA+ and DATA-).

- 8) Attach a high-speed oscilloscope with 50Ω inputs to J3.
- 9) Adjust R_{BIASMAX} (R15) and R_{APCSET} (R16) until the desired laser-bias current is achieved (refer to the note in the *Applications Information* section of the MAX3669 data sheet).
- 10) Adjust R_{MODSET} (R14) until the desired laser-modulation current is achieved.

Note: See the *Adjustment and Control Descriptions* table.

Optical Setup

For optical operation, the electrical APC test circuit must be disabled. For optical evaluation of the MAX3669ETG, configure the EV kit as described in *Component Modifications for Optical Configuration*:

- 1) Remove the shunt from P1 to enable the output.
- 2) Connect a TO-style header laser and monitor diode (Figure 1) as follows:
 - Keeping the leads to the laser diode as short as possible, connect the laser diode on the component side of the board between R20 and V_{CC} with the cathode connected to R20 and the anode connected to V_{CC}.
 - Connect the monitor diode on the underside of the board with the anode connected to the MAX3669ETG's MD pin and the cathode connected to V_{CC}.

Note: When performing resistance checks, manually set the ohmmeter to a high range to avoid forward biasing the on-chip ESD protection diodes.

- 3) Adjust R14, the MOD (R_{MODSET}) potentiometer, for maximum resistance between pins 2 and 3 (test point 5 and ground).
- 4) Adjust R15, the BIAS (R_{BIASMAX}) potentiometer, for maximum resistance between pins 2 and 3 (test point 4 and ground).
- 5) Adjust R16, the APC (R_{APCSET}) potentiometer, for desired optical power. (Refer to the *Design Procedure* section of the MAX3669 data sheet.)
- 6) Power up the board with a +3.3V supply.
- 7) Apply a differential input signal (≤800mV per side) to J1 and J2 (DATA+ and DATA-).
- 8) Attach the laser-diode output to an optical/electrical converter.

MAX3669ETG Evaluation Kit

9) Adjust R15 until LED D1 is no longer illuminated. Laser power can be monitored at the laser diode with an optical/electrical converter (refer to the note in the *Applications Information* section of the MAX3669 data sheet).

10) Adjust R14 until the desired optical amplitude is achieved. Optical amplitude can be observed on an oscilloscope connected to an optical/electrical converter.

Adjustment and Control Descriptions

See *Quick Start* first.

COMPONENT	NAME	FUNCTION
D1	APC Fail Indicator LED	Refer to the <i>Design</i> section of the MAX3669 data sheet. Set APC current; then increase bias current until LED goes off (LED is illuminated when the APC loop is open and off when the APC loop is closed).
J3	Electrical Output SMA	Electrical output. Remove for optical operation.
P1	OUTPUT DISABLE	Enable/disable the output currents. Shunting disables the part. Remove shunt for normal operation.
R14	RMODSET	Laser modulation current adjustment
R15	RBIASMAX	Laser-bias current adjustment. In open-loop mode, R15 adjusts the laser-bias current. In closed-loop operation, R15 adjusts the maximum laser-bias current.
R16	RAPCSET	Automatic power-control adjustment. For closed-loop operation, R16 adjusts the monitor-diode current level.
TP1	Fail Indicator Test Point	TTL low level indicates a failure in the APC loop.

Evaluates: MAX3669ETG

MAX3669ETG Evaluation Kit

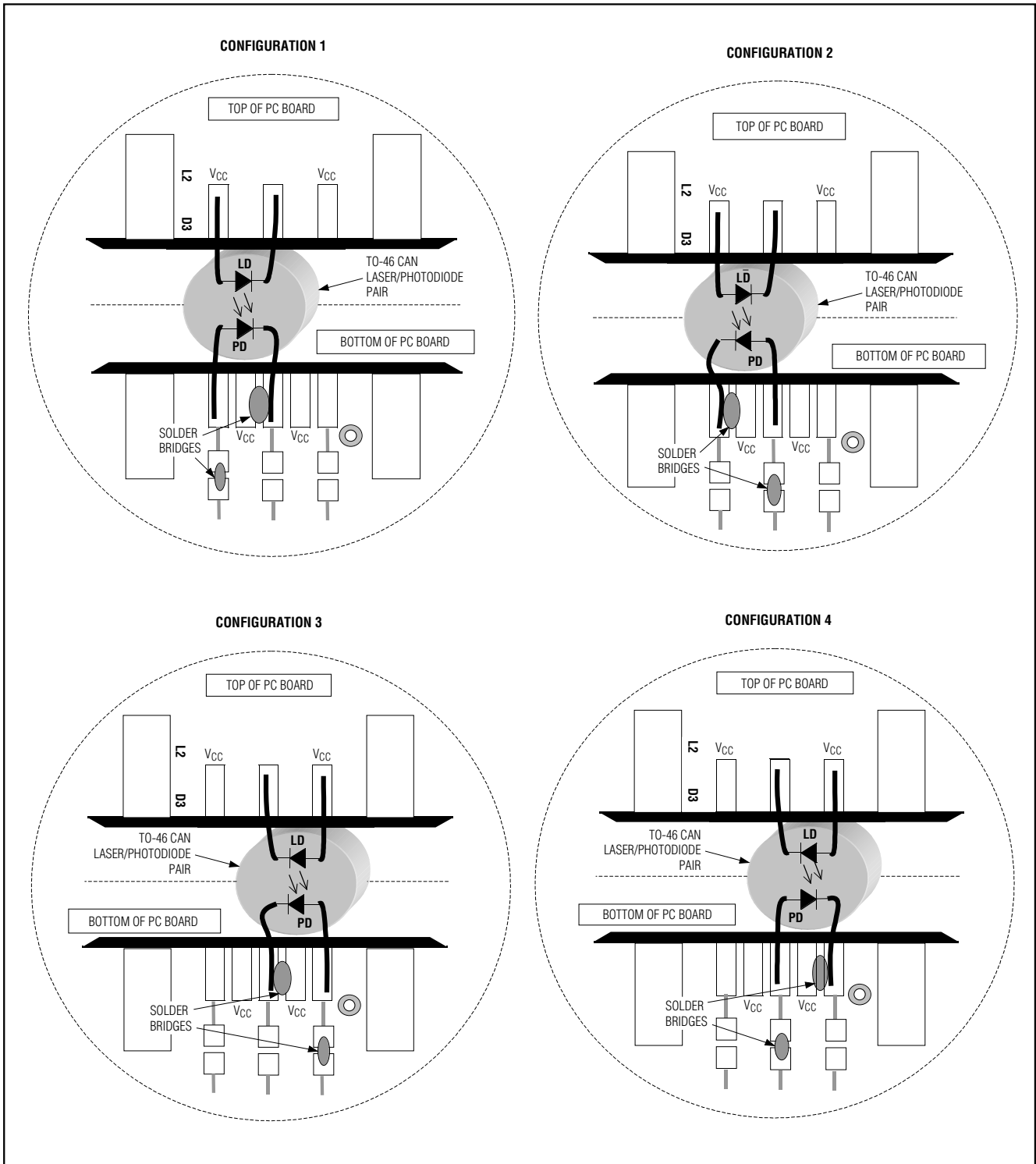

Figure 1. Attachment of Laser Diode/Monitor Diode to MAX3669ETG EV Kit

MAX3669ETG Evaluation Kit

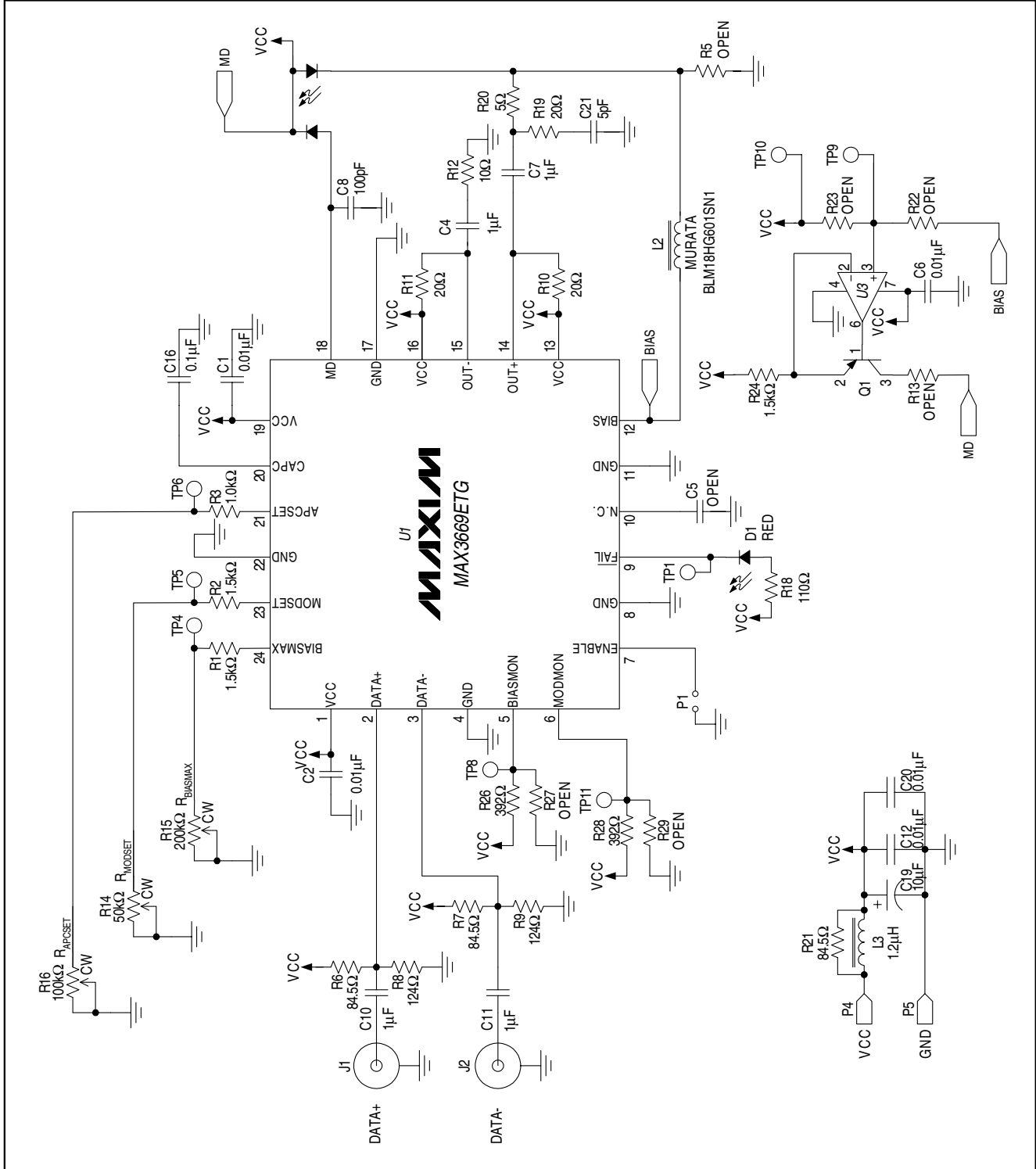

Figure 3. MAX3669ETG EV Kit Schematic—Optical Configuration

MAX3669ETG Evaluation Kit

Evaluates: MAX3669ETG

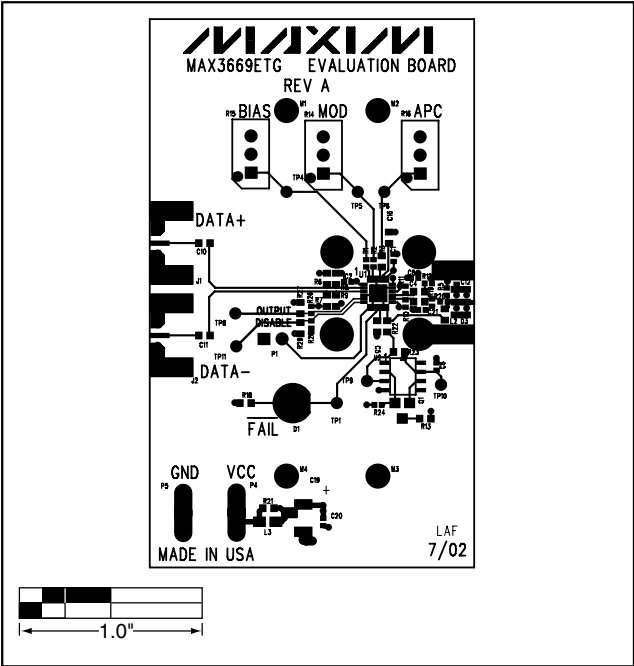

Figure 4. MAX3669ETG EV Kit Component Placement Guide—Component Side

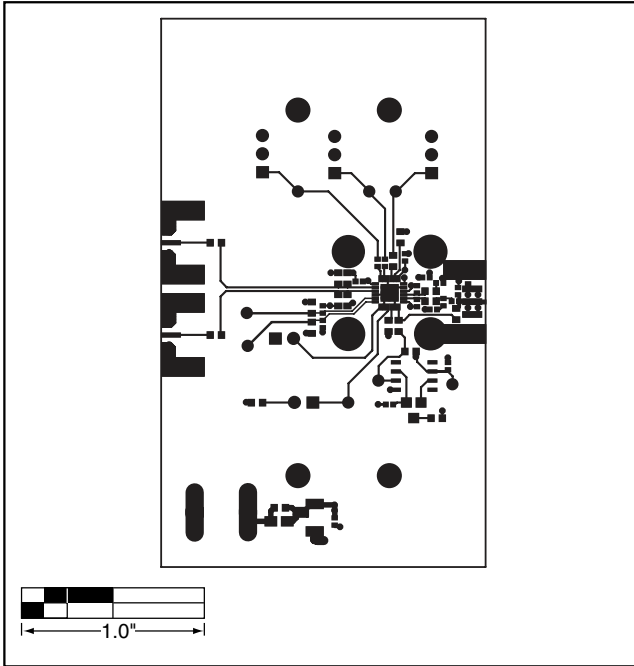

Figure 5. MAX3669ETG EV Kit PC Board Layout—Component Side

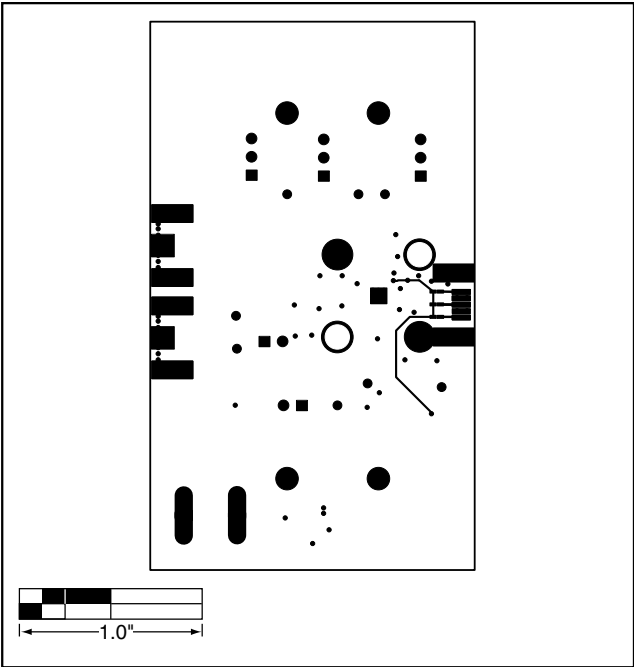

Figure 6. MAX3669ETG EV Kit PC Board Layout—Solder Side

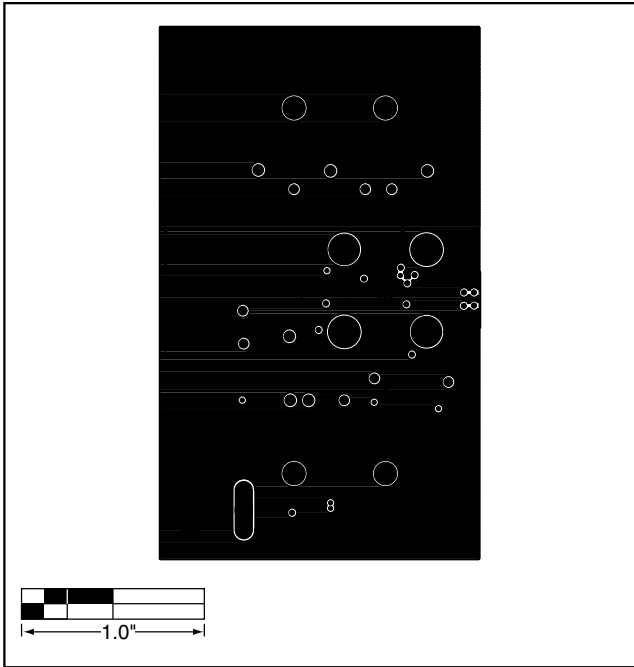

Figure 7. MAX3669ETG EV Kit PC Board Layout—Ground Plane

MAX3669ETG Evaluation Kit

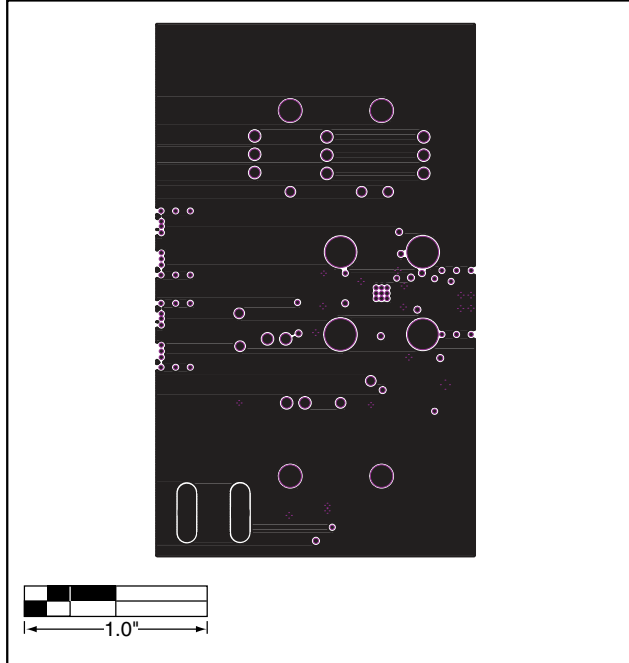

Figure 8. MAX3669ETG EV Kit PC Board Layout—Power Plane

Maxim cannot assume responsibility for use of any circuitry other than circuitry entirely embodied in a Maxim product. No circuit patent licenses are implied. Maxim reserves the right to change the circuitry and specifications without notice at any time.

8 **Maxim Integrated Products, 120 San Gabriel Drive, Sunnyvale, CA 94086 408-737-7600**