

**Features:**

- Voltage ratings 2 times or more compared to standard chip resistors
- Values up to 100MΩ
- Lower resistance values may be available - contact Stackpole
- Proportionally higher pulse power capability
- RoHS compliant and halogen free
- REACH compliant



Electrical Specifications						
Type/Code	Power Rating (W) @ 70°C	Max Working Voltage (V)	Max Overload Voltage (V)	TCR (ppm/°C)	Ohmic Range (Ω) and Tolerance	
					1%	5%
RVC0402	0.063	100	200	±100 ±200 ±400	39K - 1M	
					1.02M - 10M	1.1M - 20M
					-	22M - 100M
RVC0603	0.1	200	400	±100 ±200 ±400	56K - 1M	
					1.02M - 10M	1.1M - 20M
					-	22M - 100M
RVC0805	0.125	400	800	±100 ±200 ±400	100K - 1M	
					1.02M - 10M	1.1M - 20M
					-	22M - 100M
RVC1206	0.25	500	1000	±100 ±200 ±400	100K - 1M	
					1.02M - 10M	1.1M - 20M
					-	22M - 100M
RVC2010	0.5	2000	3000	±100 ±200 ±400	51K - 1M	
					1.02M - 20M	1.1M - 20M
					-	22M - 100M
RVC2512	1	3000	4000	±100 ±200 ±400	30K - 1M	
					1.02M - 20M	1.1M - 20M
					-	22M - 100M

Working Voltage =  $\sqrt{P \cdot R}$  or maximum working voltage listed above, whichever is lower.

Overload Voltage =  $2.5 \cdot \sqrt{P \cdot R}$  or maximum overload voltage listed above, whichever is lower.

**Mechanical Specifications**

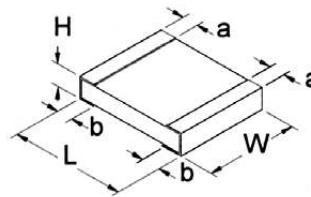

Type/Code	Weight (g) (1000 pc)	L Body Length	W Body Width	H Body Height	a Top Termination	b Bottom Termination	Unit
RVC0402	0.620	0.039 ± 0.002 1.00 ± 0.05	0.020 ± 0.002 0.50 ± 0.05	0.014 ± 0.002 0.35 ± 0.05	0.008 ± 0.004 0.20 ± 0.10	0.008 ± 0.004 0.20 ± 0.10	inches mm
RVC0603	2.042	0.063 ± 0.004 1.60 ± 0.10	0.031 ± 0.004 0.80 ± 0.10	0.018 ± 0.004 0.45 ± 0.10	0.012 ± 0.008 0.30 ± 0.20	0.012 ± 0.008 0.30 ± 0.20	inches mm
RVC0805	4.368	0.079 ± 0.004 2.00 ± 0.10	0.049 ± 0.004 1.25 ± 0.10	0.020 ± 0.004 0.50 ± 0.10	0.014 ± 0.008 0.35 ± 0.20	0.016 ± 0.008 0.40 ± 0.20	inches mm
RVC1206	8.947	0.122 ± 0.004 3.10 ± 0.10	0.061 ± 0.004 1.55 ± 0.10	0.022 ± 0.004 0.55 ± 0.10	0.020 ± 0.010 0.50 ± 0.25	0.020 ± 0.008 0.50 ± 0.20	inches mm

Mechanical Specifications (cont.)							
Type/Code	Weight (g) (1000 pc)	L Body Length	W Body Width	H Body Height	a Top Termination	b Bottom Termination	Unit
RVC2010	24.241	0.197 ± 0.008	0.098 ± 0.006	0.022 ± 0.004	0.024 ± 0.010	0.020 ± 0.008	inches
		5.00 ± 0.20	2.50 ± 0.15	0.55 ± 0.10	0.60 ± 0.25	0.50 ± 0.20	mm
RVC2512	39.448	0.250 ± 0.008	0.126 ± 0.006	0.022 ± 0.004	0.024 ± 0.010	0.020 ± 0.008	inches
		6.35 ± 0.20	3.20 ± 0.15	0.55 ± 0.10	0.60 ± 0.25	0.50 ± 0.20	mm

Performance Characteristics				
Test	Test Method	Test Specification		Test Method
		± 1%	± 5%	
Temperature Coefficient of Resistance (TCR)	JIS-C-5201-1 4.8 IEC-60115-1 4.8	As specified by Electrical Specification Table		-55°C ~ +125°C, 25°C is the reference temperature
Short Time Overload	JIS-C-5201-1 4.13 IEC-60115-1 4.13	±(1% + 0.05Ω)	±(2% + 0.05Ω)	RCWV * 2.5 or Max. Overload Voltage whichever is lower for 5 seconds
Insulation Resistance	JIS-C-5201-1 4.6 IEC-60115-1 4.6	≥ 10G		Max. Overload voltage for 1 minute
Endurance	JIS-C-5201-1 4.25 IEC-60115-1 4.25.1	±(2% + 0.1Ω)	±(3% + 0.1Ω)	70°C ± 2°C, RCWV for 1000 hours with 1.5 hour "ON" and 0.5 hour "OFF"
Damp Heat with Load	JIS-C-5201-1 4.24 IEC-60115-1 4.24	±(2% + 0.1Ω)	±(3% + 0.1Ω)	40°C ± 2°C, 90% ~ 95% R.H., RCWV for 1000 hours with 1.5 hour "ON" and 0.5 hour "OFF"
Dry Heat	JIS-C-5201-1 4.23 IEC-60115-1 4.23.2	±(1% + 0.05Ω)	±(1.5% + 0.1Ω)	at +155°C for 1000 hours
Bending Strength	JIS-C-5201-1 4.33 IEC-60115-1 4.33	±(1% + 0.05Ω)	±(1% + 0.05Ω)	Bending once for 5 seconds 2010, 2512 sizes: 2 mm; other sizes: 3 mm
Solderability	JIS-C-5201-1 4.17 IEC-60115-1 4.17	95% min. coverage		245°C ± 5°C for 3 seconds
Resistance to Soldering Heat	JIS-C-5201-1 4.18 IEC-60115-1 4.18	±(0.5% + 0.05Ω)	±(1% + 0.05Ω)	260°C ± 5°C for 10 seconds
Voltage Proof	JIS-C-5201-1 4.7 IEC-60115-1 4.7	No breakdown or flashover		0402: 150V for 1 minute 0603: 300V for 1 minute 0805, 1206, 2010, 2512: 500V for 1 minute
Leaching	JIS-C-5201-1 4.18 IEC-60068-2-58 8.2.1	Individual leaching area ≤ 5% Total leaching area ≤ 10%		260°C ± 5°C for 30 seconds
Rapid Change of Temperature	JIS-C-5201-1 4.19 IEC-60115-1 4.19	±(0.5% + 0.05Ω)	±(1% + 0.05Ω)	-55°C to +155°C, 5 cycles

RCWV (Rated continuous working voltage) =  $\sqrt{P \cdot R}$  or Max. Operating Voltage whichever is lower.

Storage temperature: 25°C ± 3°C; humidity < 80% RH

Operating temperature range is -55°C to 155°C

**Power Derating Curve:**

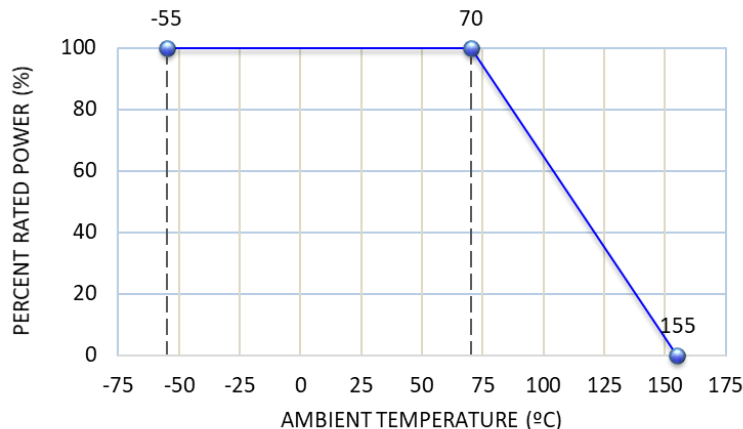

**Recommended Pad Layout**

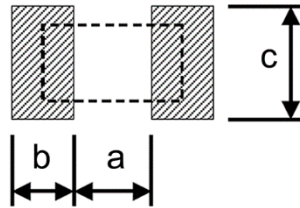

Type/Code	a	b	c	Unit
RVC0402	0.020	0.018	0.024	inches
	0.50	0.45	0.60	mm
RVC0603	0.035	0.024	0.035	inches
	0.90	0.60	0.90	mm
RVC0805	0.047	0.028	0.051	inches
	1.20	0.70	1.30	mm
RVC1206	0.079	0.035	0.063	inches
	2.00	0.90	1.60	mm
RVC2010	0.150	0.035	0.110	inches
	3.80	0.90	2.80	mm
RVC2512	0.193	0.063	0.138	inches
	4.90	1.60	3.50	mm

**Soldering Conditions**

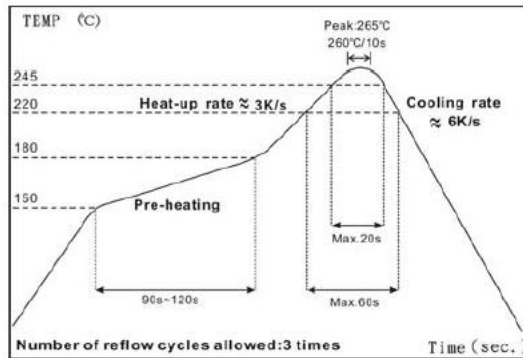

IR Reflow Soldering

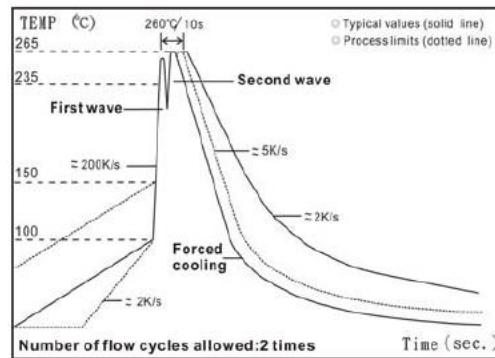

Wave Soldering (Flow Soldering)

- (1) Time of IR reflow soldering at maximum temperature point 260°C: 10 seconds
- (2) Time of wave soldering at maximum temperature point 260°C: 10 seconds
- (3) Time of soldering iron at maximum temperature point 410°C: 5 seconds

**Reel Specifications**

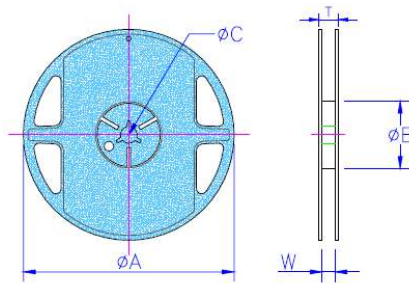

Type/Code	Tape Width (mm)	Reel Diameter (inches)	A	B	C	W	T	Unit
RVC0402, RVC0603 RVC0805, RVC1206	8 mm	7"	7.028 ± 0.059 178.50 ± 1.50	2.362 ± 0.039 60.00 ± 1.00	0.512 ± 0.008 13.00 ± 0.20	0.354 ± 0.020 9.00 ± 0.50	0.492 ± 0.020 12.50 ± 0.50	inches mm
RVC2010, RVC2512	12 mm	7"	7.028 ± 0.059 178.50 ± 1.50	2.362 ± 0.039 60.00 ± 1.00	0.512 ± 0.020 13.00 ± 0.50	0.512 ± 0.020 13.00 ± 0.50	0.610 ± 0.020 15.50 ± 0.50	inches mm

**Paper Tape Specifications**

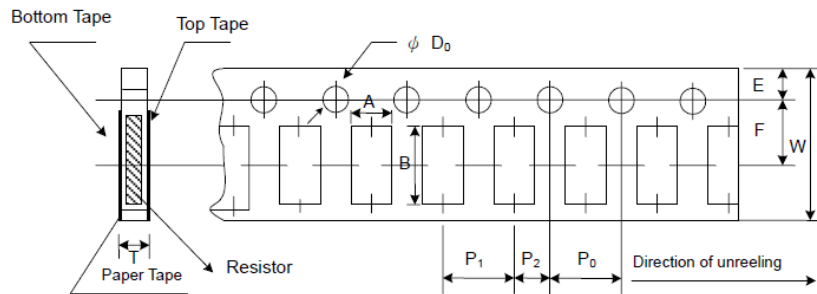

Type/Code	A	B	W	E	F	Unit
RVC0402	0.026 ± 0.004 0.65 ± 0.10	0.045 ± 0.004 1.15 ± 0.10	0.315 ± 0.008 8.00 ± 0.20	0.069 ± 0.004 1.75 ± 0.10	0.138 ± 0.002 3.50 ± 0.05	inches mm
RVC0603	0.043 ± 0.004 1.10 ± 0.10	0.075 ± 0.004 1.90 ± 0.10	0.315 ± 0.008 8.00 ± 0.20	0.069 ± 0.004 1.75 ± 0.10	0.138 ± 0.002 3.50 ± 0.05	inches mm
RVC0805	0.063 ± 0.004 1.60 ± 0.10	0.094 ± 0.008 2.40 ± 0.20	0.315 ± 0.008 8.00 ± 0.20	0.069 ± 0.004 1.75 ± 0.10	0.138 ± 0.002 3.50 ± 0.05	inches mm
RVC1206	0.075 ± 0.004 1.90 ± 0.10	0.138 ± 0.008 3.50 ± 0.20	0.315 ± 0.008 8.00 ± 0.20	0.069 ± 0.004 1.75 ± 0.10	0.138 ± 0.002 3.50 ± 0.05	inches mm
Type/Code	P0	P1	P2	D	T	Unit
RVC0402	0.157 ± 0.004 4.00 ± 0.10	0.079 ± 0.002 2.00 ± 0.05	0.079 ± 0.002 2.00 ± 0.05	0.059 ± 0.004 1.50 ± 0.10	0.018 ± 0.004 0.45 ± 0.10	inches mm
RVC0603	0.157 ± 0.004 4.00 ± 0.10	0.157 ± 0.002 4.00 ± 0.05	0.079 ± 0.002 2.00 ± 0.05	0.059 ± 0.004 1.50 ± 0.10	0.028 ± 0.004 0.70 ± 0.10	inches mm
RVC0805	0.157 ± 0.004 4.00 ± 0.10	0.157 ± 0.002 4.00 ± 0.05	0.079 ± 0.002 2.00 ± 0.05	0.059 ± 0.004 1.50 ± 0.10	0.031 ± 0.004 0.80 ± 0.10	inches mm
RVC1206	0.157 ± 0.004 4.00 ± 0.10	0.157 ± 0.002 4.00 ± 0.05	0.079 ± 0.002 2.00 ± 0.05	0.059 ± 0.004 1.50 ± 0.10	0.033 ± 0.004 0.85 ± 0.10	inches mm

**Embossed Plastic Tape Specifications**

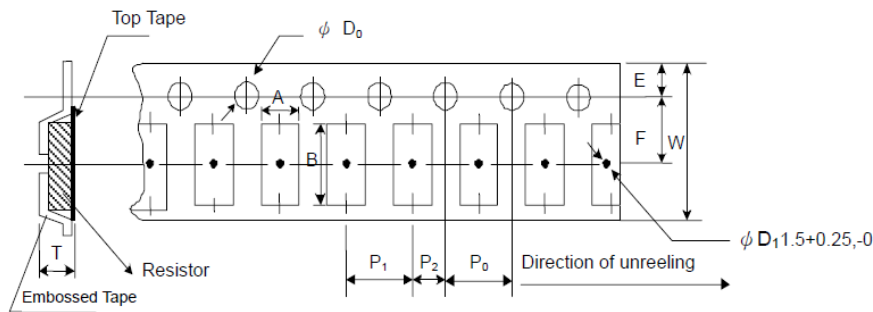

Type/Code	A	B	W	E	F	Unit
RVC2010	0.110 ± 0.004	0.217 ± 0.004	0.472 ± 0.012	0.069 ± 0.004	0.217 ± 0.002	inches
	2.80 ± 0.10	5.50 ± 0.10	12.00 ± 0.30	1.75 ± 0.10	5.50 ± 0.05	mm
RVC2512	0.138 ± 0.004	0.264 ± 0.004	0.472 ± 0.012	0.069 ± 0.004	0.217 ± 0.002	inches
	3.50 ± 0.10	6.70 ± 0.10	12.00 ± 0.30	1.75 ± 0.10	5.50 ± 0.05	mm
Type/Code	P0	P1	P2	D	T	Unit
RVC2010	0.157 ± 0.004	0.157 ± 0.004	0.079 ± 0.002	0.059 ± 0.004	0.047	inches
	4.00 ± 0.10	4.00 ± 0.10	2.00 ± 0.05	1.50 ± 0.10	1.20	mm
RVC2512	0.157 ± 0.004	0.157 ± 0.004	0.079 ± 0.002	0.059 ± 0.004	0.047	inches
	4.00 ± 0.10	4.00 ± 0.10	2.00 ± 0.05	1.50 ± 0.10	1.20	mm

**RoHS Compliance**

Stackpole Electronics has joined the worldwide effort to reduce the amount of lead in electronic components and to meet the various regulatory requirements now prevalent, such as the European Union’s directive regarding “Restrictions on Hazardous Substances” (RoHS 3). As part of this ongoing program, we periodically update this document with the status regarding the availability of our compliant components. All our standard part numbers are compliant to EU Directive 2011/65/EU of the European Parliament as amended by Directive (EU) 2015/863/EU as regards the list of restricted substances.

**RoHS Compliance Status**

Standard Product Series	Description	Package / Termination Type	Standard Series RoHS Compliant	Lead-Free Termination Composition	Lead-Free Mfg. Effective Date (Std Product Series)	Lead-Free Effective Date Code (YY/WW)
RVC	Medium Voltage Thick Film Surface Mount Chip Resistor	SMD	YES(1)	100% Matte Sn over Ni	Jan-03	03/01

Note (1): RoHS Compliant by means of exemption 7c-l.

**“Conflict Metals” Commitment**

We at Stackpole Electronics, Inc. are joined with our industry in opposing the use of metals mined in the “conflict region” of the eastern Democratic Republic of the Congo (DRC) in our products. Recognizing that the supply chain for metals used in the electronics industry is very complex, we work closely with our own suppliers to verify to the extent possible that the materials and products we supply do not contain metals sourced from this conflict region. As such, we are in compliance with the requirements of Dodd-Frank Act regarding Conflict Minerals.

**Compliance to “REACH”**

We certify that all passive components supplied by Stackpole Electronics, Inc. are SVHC (Substances of Very High Concern) free and compliant with the requirements of EU Directive 1907/2006/EC, “The Registration, Evaluation, Authorization and Restriction of Chemicals”, otherwise referred to as REACH. Contact us for complete list of REACH Substance Candidate List.

**Environmental Policy**

It is the policy of Stackpole Electronics, Inc. (SEI) to protect the environment in all localities in which we operate. We continually strive to improve our effect on the environment. We observe all applicable laws and regulations regarding the protection of our environment and all requests related to the environment to which we have agreed. We are committed to the prevention of all forms of pollution.

**How to Order**

