

Dual P-Channel Enhancement Mode Field Effect Transistor

General Description

The AON2801 uses advanced trench technology to provide excellent $R_{DS(ON)}$, low gate charge and operation with gate voltages as low as 1.8V. This device is suitable for use as a load switch or in PWM applications.

RoHS and Halogen-Free Compliant

Features

$V_{DS} (V) = -20V$
 $I_D = -3A$ ($V_{GS} = -4.5V$)
 $R_{DS(ON)} < 120m\Omega$ ($V_{GS} = -4.5V$)
 $R_{DS(ON)} < 160m\Omega$ ($V_{GS} = -2.5V$)
 $R_{DS(ON)} < 200m\Omega$ ($V_{GS} = -1.8V$)



DFN 2x2 Package

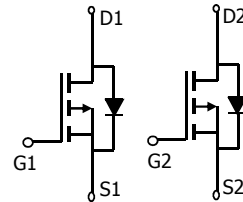
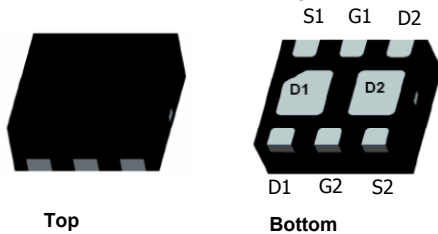

Parameter	Symbol	Maximum	Units
Drain-Source Voltage	V_{DS}	-20	V
Gate-Source Voltage	V_{GS}	± 8	V
Continuous Drain Current ^A	I_D	$T_A = 25^\circ C$	A
		$T_A = 70^\circ C$	
Pulsed Drain Current ^C	I_{DM}	-15	
Power Dissipation ^A	P_{DSM}	$T_A = 25^\circ C$	W
		$T_A = 70^\circ C$	
Junction and Storage Temperature Range	T_J, T_{STG}	-55 to 150	$^\circ C$

Thermal Characteristics

Parameter	Symbol	Typ	Max	Units
Maximum Junction-to-Ambient ^A	$R_{\theta JA}$	35	45	$^\circ C/W$
Maximum Junction-to-Ambient ^A		Steady-State	65	
Maximum Junction-to-Ambient ^B	$R_{\theta JA}$	120	155	$^\circ C/W$
Maximum Junction-to-Ambient ^B		Steady-State	175	

Electrical Characteristics (T_J=25°C unless otherwise noted)

Symbol	Parameter	Conditions	Min	Typ	Max	Units
STATIC PARAMETERS						
BV _{DSS}	Drain-Source Breakdown Voltage	I _D =-250μA, V _{GS} =0V	-20			V
I _{DSS}	Zero Gate Voltage Drain Current	V _{DS} =-20V, V _{GS} =0V T _J =55°C			-1 -5	μA
I _{GSS}	Gate-Body leakage current	V _{DS} =0V, V _{GS} =±8V			±100	nA
V _{GS(th)}	Gate Threshold Voltage	V _{DS} =V _{GS} I _D =-250μA	-0.3	-0.55	-1	V
I _{D(ON)}	On state drain current	V _{GS} =-4.5V, V _{DS} =-5V	-15			A
R _{DS(ON)}	Static Drain-Source On-Resistance	V _{GS} =-4.5V, I _D =-3A T _J =125°C		100 135	120 170	mΩ
		V _{GS} =-2.5V, I _D =-2.6A		128	160	mΩ
		V _{GS} =-1.8V, I _D =-1.5A		160	200	mΩ
g _{FS}	Forward Transconductance	V _{DS} =-5V, I _D =-3A		6		S
V _{SD}	Diode Forward Voltage	I _S =-1A, V _{GS} =0V		-0.76		V
I _S	Maximum Body-Diode Continuous Current				-1	A
DYNAMIC PARAMETERS						
C _{ISS}	Input Capacitance	V _{GS} =0V, V _{DS} =-10V, f=1MHz		540	700	pF
C _{OSS}	Output Capacitance			90		pF
C _{RSS}	Reverse Transfer Capacitance			63		pF
R _g	Gate resistance	V _{GS} =0V, V _{DS} =0V, f=1MHz		9.5		Ω
SWITCHING PARAMETERS						
Q _g	Total Gate Charge	V _{GS} =-4.5V, V _{DS} =-10V, I _D =-3A		5	6.5	nC
Q _{gs}	Gate Source Charge			1.2		nC
Q _{gd}	Gate Drain Charge			1		nC
t _{D(on)}	Turn-On DelayTime	V _{GS} =-4.5V, V _{DS} =-10V, R _L =1.5Ω, R _{GEN} =3Ω		5		ns
t _r	Turn-On Rise Time			40		ns
t _{D(off)}	Turn-Off DelayTime			28.5		ns
t _f	Turn-Off Fall Time			46		ns
t _{rr}	Body Diode Reverse Recovery Time		I _F =-3A, dI/dt=100A/μs		21	28
Q _{rr}	Body Diode Reverse Recovery Charge	I _F =-3A, dI/dt=100A/μs		9.1		nC

A: The value of R_{θJA} is measured with the device mounted on 1in² FR-4 board with 2oz. Copper, in a still air environment with T_A=25° C. The Power dissipation P_{DSM} is based on R_{θJA} and the maximum allowed junction temperature of 150° C. The value in any given application depends on the user's specific board design, and the maximum temperature of 150° C may be used if the PCB allows it to.

B: The value of R_{θJA} is measured with the device mounted on a minimum pad board with 2oz. Copper, in a still air environment with T_A=25° C. The Power dissipation P_{DSM} is based on R_{θJA} and the maximum allowed junction temperature of 150° C. The value in any given application depends on the user's specific board design, and the maximum temperature of 150° C may be used if the PCB allows it to.

C: The R_{θJA} is the sum of the thermal impedance from junction to case R_{θJC} and case to ambient.

D: The static characteristics in Figures 1 to 6 are obtained using <300 μs pulses, duty cycle 0.5% max.

E: These tests are performed with the device mounted on 1 in² FR-4 board with 2oz. Copper, in a still air environment with T_A=25° C. The SOA curve provides a single pulse rating.

*This device is guaranteed green after data code 7111 (Oct 15 2007).

THIS PRODUCT HAS BEEN DESIGNED AND QUALIFIED FOR THE CONSUMER MARKET. APPLICATIONS OR USES AS CRITICAL COMPONENTS IN LIFE SUPPORT DEVICES OR SYSTEMS ARE NOT AUTHORIZED. AOS DOES NOT ASSUME ANY LIABILITY ARISING OUT OF SUCH APPLICATIONS OR USES OF ITS PRODUCTS. AOS RESERVES THE RIGHT TO IMPROVE PRODUCT DESIGN, FUNCTIONS AND RELIABILITY WITHOUT NOTICE



TYPICAL ELECTRICAL AND THERMAL CHARACTERISTICS

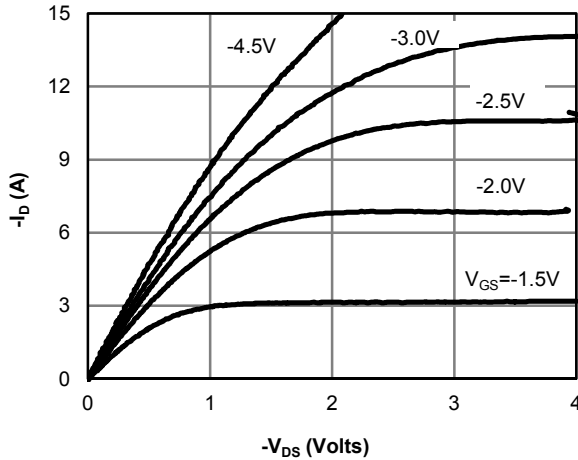

Figure 1: On-Region Characteristics

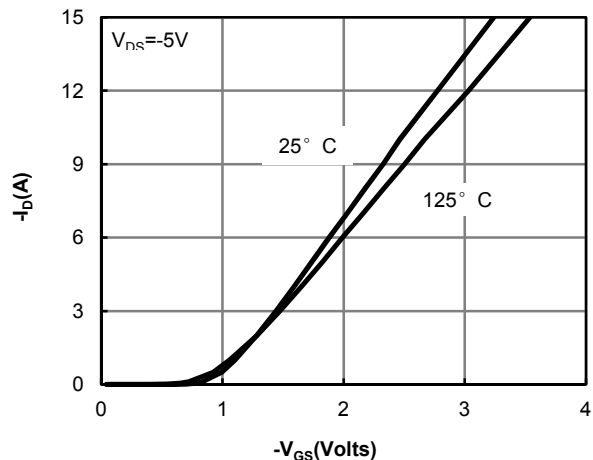

Figure 2: Transfer Characteristics

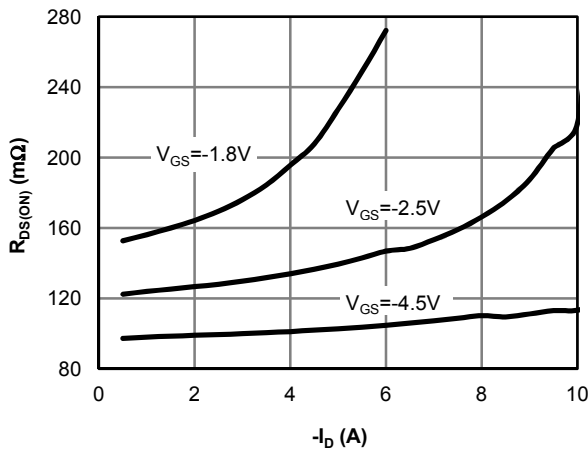

Figure 3: On-Resistance vs. Drain Current and Gate Voltage

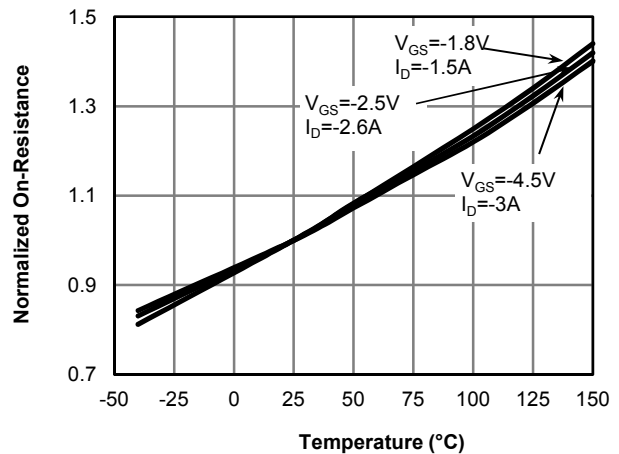

Figure 4: On-Resistance vs. Junction Temperature (Note E)

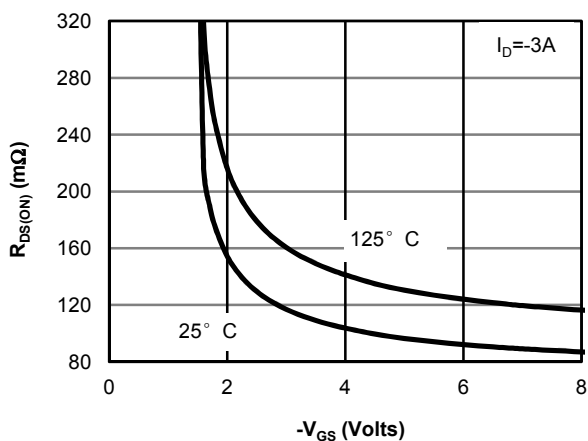

Figure 5: On-Resistance vs. Gate-Source Voltage

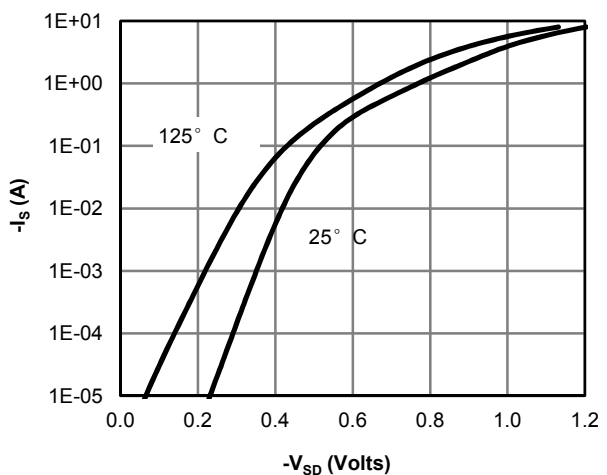

Figure 6: Body-Diode Characteristics



TYPICAL ELECTRICAL AND THERMAL CHARACTERISTICS

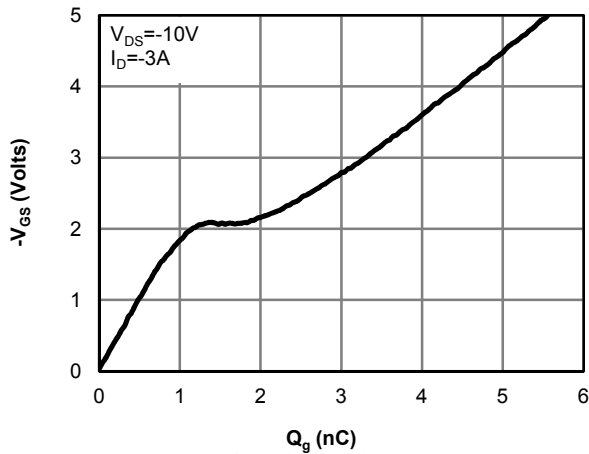

Figure 7: Gate-Charge Characteristics

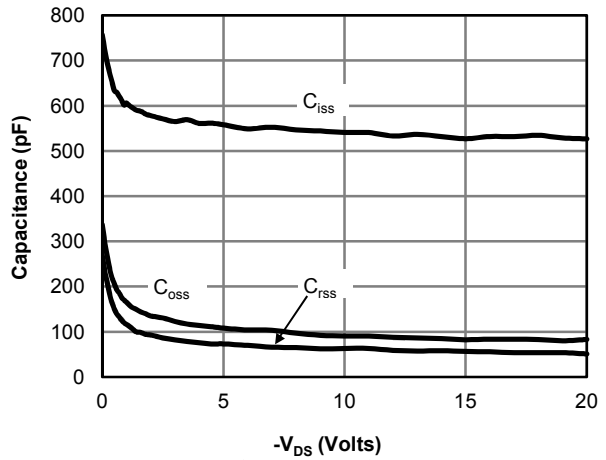

Figure 8: Capacitance Characteristics

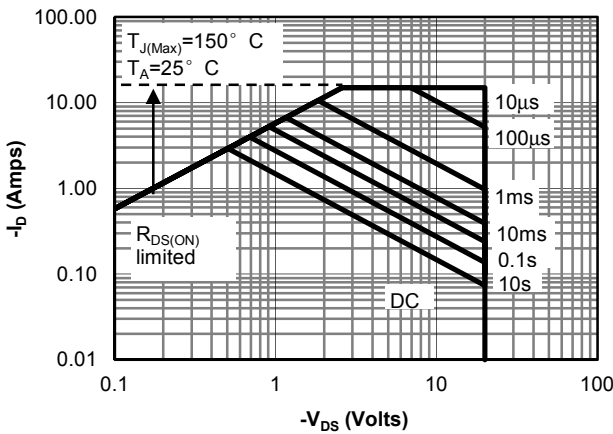

Figure 9: Maximum Forward Biased Safe Operating Area (Note E)

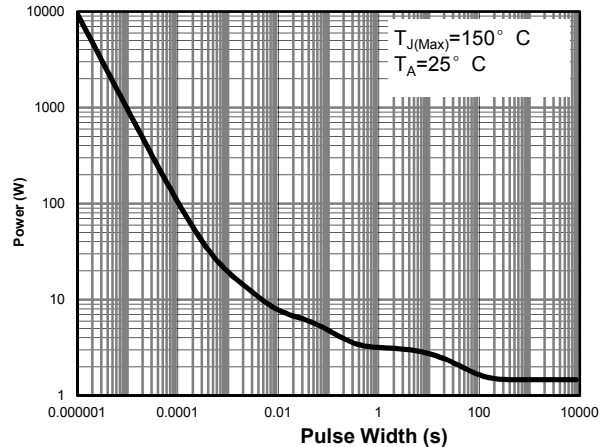

Figure 10: Single Pulse Power Rating Junction-to-Ambient (Note E)

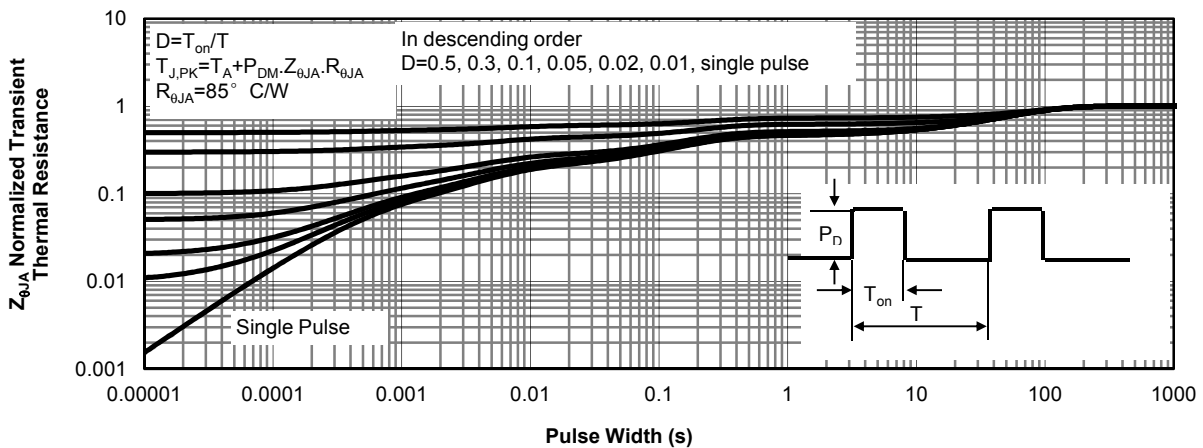
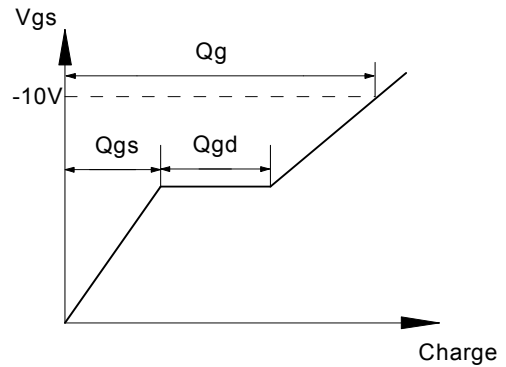
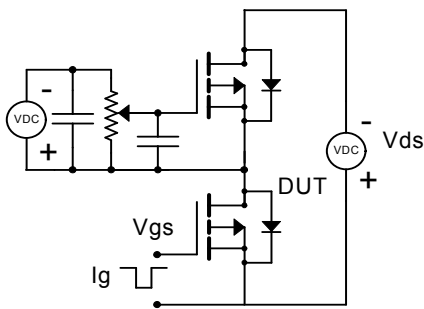
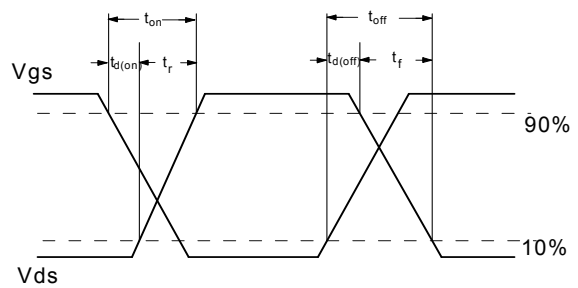
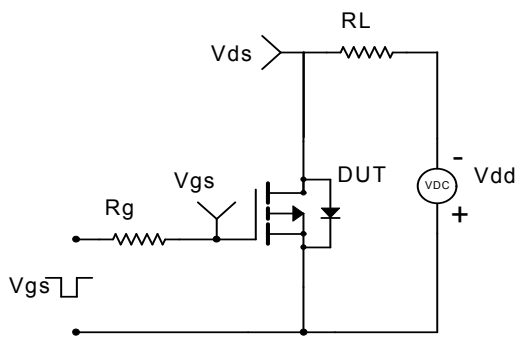

Figure 11: Normalized Maximum Transient Thermal Impedance (Note F)

Gate Charge Test Circuit & Waveform



Resistive Switching Test Circuit & Waveforms



Diode Recovery Test Circuit & Waveforms

