

Product Description

Description:	76.80MHz GSX-213/X SM Crystal
Product family:	GSX-213
Category:	SM Quartz Crystal
Order code:	MP11652

Features

- ▶ Ultra-miniature for maximum space saving
- ▶ Metal lid grounded to minimise EMI
- ▶ Seam sealed for excellent long-term stability

Additional Information

For further information regarding packaging, construction, material composition, soldering profile and environment, please refer to **GSX-213 Product Information sheet**

For dimensions, refer to package drawing: **D0324-A**

Electrical Specifications

Parameter	Value	Notes
Nominal frequency:	76.80MHz	
Calibration tolerance:	±10ppm	@25°C ±3°C
Temperature stability:	±15ppm	Referred to the value at 25°C
Operating temperature range:	-40 to +85°C	
Storage temperature range:	-40 to +85°C	
Circuit condition:	10pF	
Oscillation mode:	Fundamental	
Equivalent series resistance:	30Ω max	
Ageing:	±2ppm	Per year
Drive level:	50μW typ, 200μW max	
Static capacitance:	3pF max	

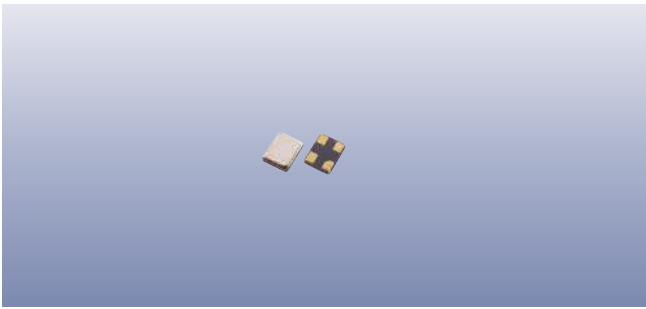

Construction

- ▮ Ceramic body with gold-plated pads
- ▮ Metal lid, seam sealed

Composition



This product is lead-free, and is fully compliant with current RoHS directives



Packaging & Handling

Production quantities supplied on T&R, 3k pcs per reel.
Small quantities may be supplied on tape (no reel), or in bulk.

Marking

FREQUENCY
T DC

Marking type: Laser
DC = Date code

Tape & Reel Specification

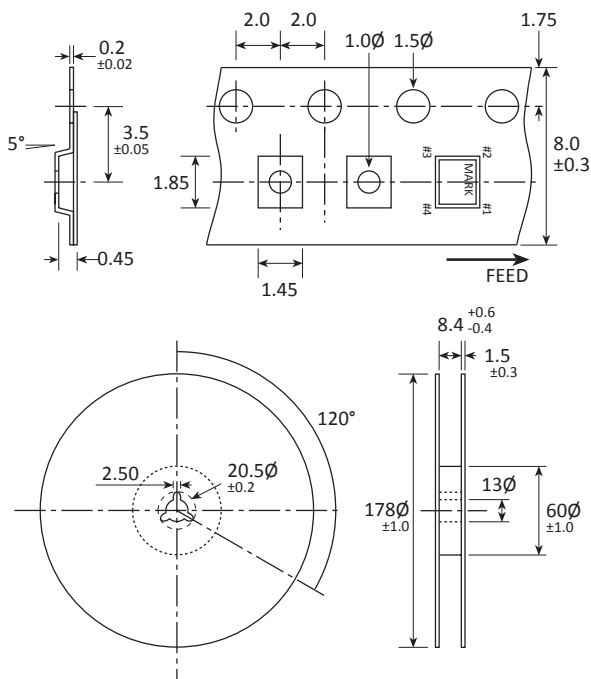

Not to scale. Dimensional tolerances ±0.1mm unless otherwise stated.

Soldering Profile

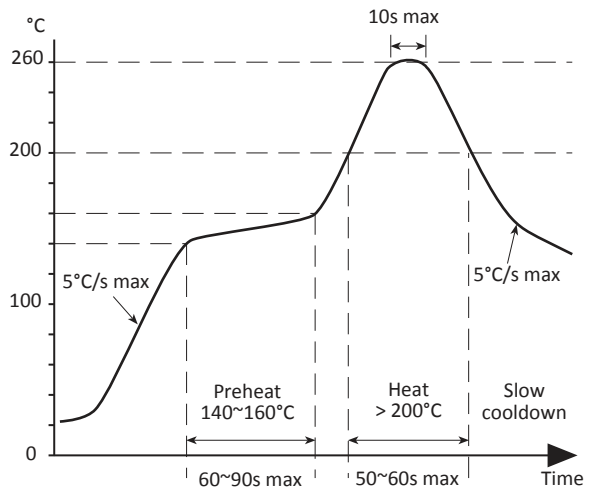

Maximum solder resistance: 260°C x 10 secs x 2.

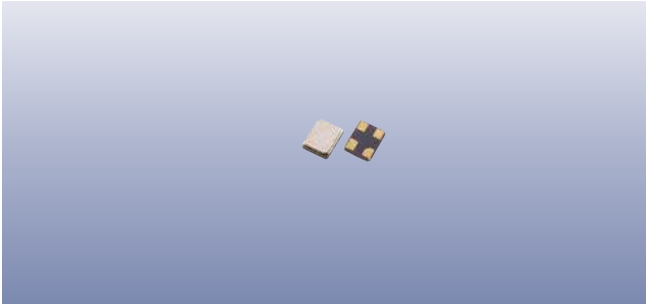

Product Family

GSX-213, GRX-210

Construction

- ▮ Ceramic body with gold-plated pads
- ▮ Metal lid, seam sealed

Dimensions (mm)

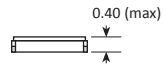
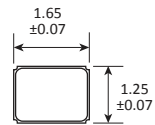

SOLDER PAD LAYOUT

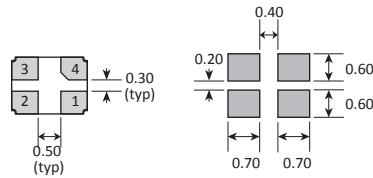

PAD	CONNECTION
1	Crystal
2	Ground & lid
3	Crystal
4	Ground/NC