

WLH60 High Temperature LED Light

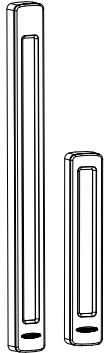

Datasheet

Banner's WLH60 High Temperature Lights are engineered to withstand harsh, extreme temperature environments, making it the first choice for a machine lighting solution. A conservative mechanical design protects against liquid ingress and state-of-the-art LED technology delivers best of class brightness.



Choose between a durable polycarbonate window or a borosilicate glass (BSG) option featuring enhanced chemical and thermal resistance. This smart industrial lighting solution also features an energy efficient eco-mode dimming state to tailor the lumen levels and power consumption to the applications.

- Approved for use in environments up to 100 °C (212 °F)
- Rugged and durable for harsh environments
- Oil, chemical, and water resistant with IEC IP67, JIS C IP68G, and IP69K per DIN 40050-9 ratings
- Easy to install with a wide variety of mounting solutions
- Highly resistant to vibration and shock



Important: Read the following instructions before operating the light. Please download the complete WLH60 High Temperature LED Light technical documentation, available in multiple languages, from www.bannerengineering.com for details on the proper use, applications, Warnings, and installation instructions of this device.



Important: Lea el siguiente instructivo antes de operar el luminario. Por favor descargue desde www.bannerengineering.com toda la documentación técnica de los WLH60 High Temperature LED Light, disponibles en múltiples idiomas, para detalles del uso adecuado, aplicaciones, advertencias, y las instrucciones de instalación de estos dispositivos.



Important: Lisez les instructions suivantes avant d'utiliser le luminaire. Veuillez télécharger la documentation technique complète des WLH60 High Temperature LED Light sur notre site www.bannerengineering.com pour les détails sur leur utilisation correcte, les applications, les notes de sécurité et les instructions de montage.

Models

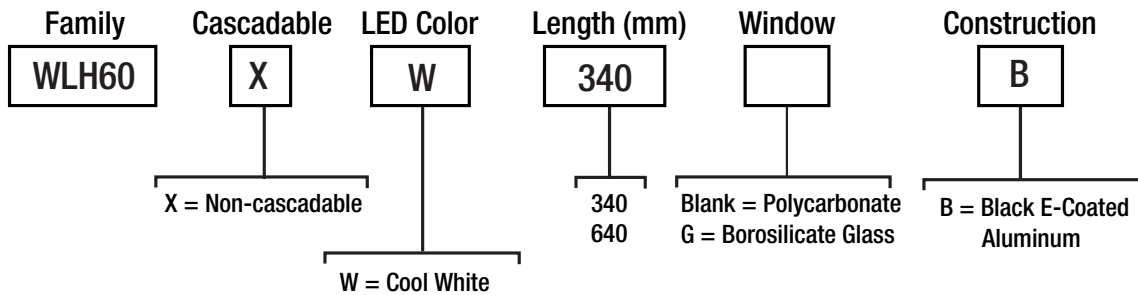

Connection (Standard): 2 m (6.5 ft) integral FEP cable
 Connection (W/15): 5 m (15 ft) integral FEB cable
 Connection (W/30): 10 m (30 ft) integral FEB cable

The following caution applies to white LED models:



CAUTION:
Risk Group 2: Possibly hazardous optical radiation emitted from this product.

Do not stare at the operating lamp. May be harmful to the eyes. Risk Group 2 (RG 2) products generally do not pose a realistic optical hazard if aversion responses limit the exposure duration or where lengthy exposures are unrealistic.
 - IEC 62471



Wiring Diagram

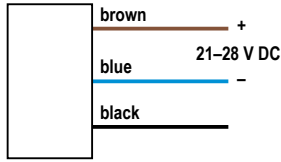

Wire Color	Connection
brown	21 V DC to 28 V DC
blue	DC common
black	Connect to 21 V DC to 28 V DC for 50% intensity. For 100% intensity, leave the black wire floating or connected to common.

Specifications

Supply Voltage

21 V DC to 28 V DC
Use only with a suitable Class 2 power supply (UL) or SELV power supply (CE)
See the electrical characteristics on the product label.

Supply Current

Light Length	Typical Current (A) at 25 °C	Typical Current (A) at 100 °C	Maximum Current (A) at -40 °C
340 mm	0.80	0.55	1.05
640 mm	1.60	1.10	2.10

Supply Protection Circuitry

Protected against reverse polarity and transient voltages

Construction

Black e-coated aluminum housing, polycarbonate or borosilicate glass window

Spacing Criterion

Vertical: 1.17
Horizontal: 1.39

Operating Conditions

-40 to +100 °C (-40 to +212 °F)
90% maximum relative humidity (non-condensing)

Storage Temperature

-40 to +100 °C (-40 to +212 °F)

Environmental Rating

IEC IP67, JIS C IP68G, IP69K per DIN 40050-9

Vibration and Mechanical Shock

Vibration: 10 Hz to 55 Hz, 1.0 mm peak-to-peak amplitude per IEC 60068-2-6
Shock: 15G 11 ms duration, half sine wave per IEC 60068-2-27

Certifications



Light Characteristics

Cool white color temperature (CCT): 6500K (+600K/-500K)
CRI: 80 minimum

Light Length	Light Output ¹	
	Lumens at 25 °C	Lumens at 100 °C
340 mm	1150	740
640 mm	2300	1480

LED Lifetime

Lumen Maintenance: L₇₀
When operating within specifications, output decreases less than 30% after 36,000 hours

Mounting

Multiple bracket options available

Connections

2 m (6.5 ft) Fluorinated Ethylene Propylene (FEP) integral cable

Required Overcurrent Protection



WARNING: Electrical connections must be made by qualified personnel in accordance with local and national electrical codes and regulations.

Overcurrent protection is required to be provided by end product application per the supplied table.
Overcurrent protection may be provided with external fusing or via Current Limiting, Class 2 Power Supply.
Supply wiring leads < 24 AWG shall not be spliced.
For additional product support, go to www.bannerengineering.com.

Supply Wiring (AWG)	Required Overcurrent Protection (Amps)
20	5.0
22	3.0
24	2.0
26	1.0
28	0.8
30	0.5

¹ Values shown at 25 °C - current and lumen values decrease 0.475% per 1 °C from ambient. For example, a 640 mm unit will have a maximum current of 2.10 A at -40 °C and 1.03 A at +100 °C.

Light Characteristics

340 mm Models

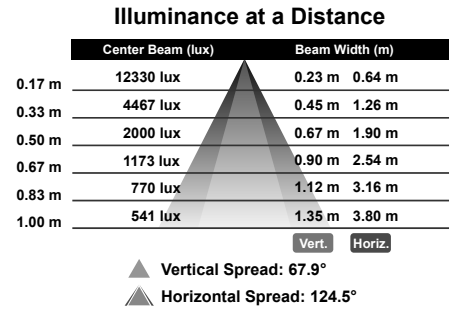
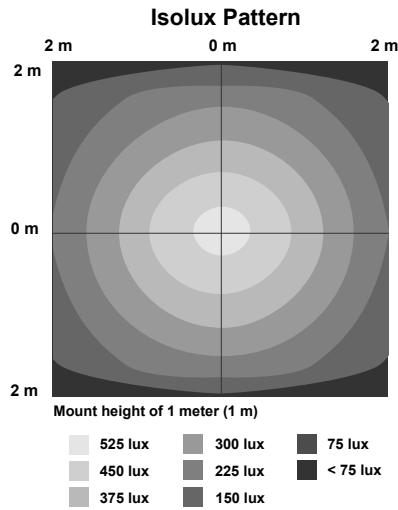
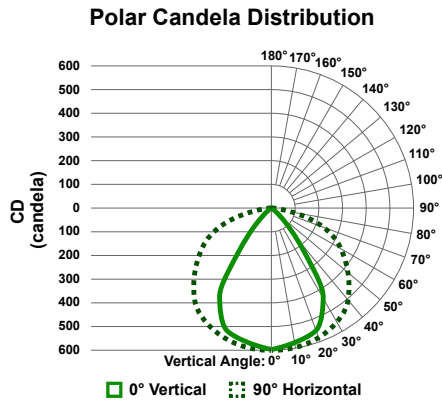

640 mm Models

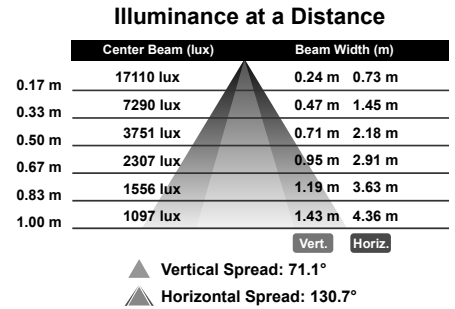
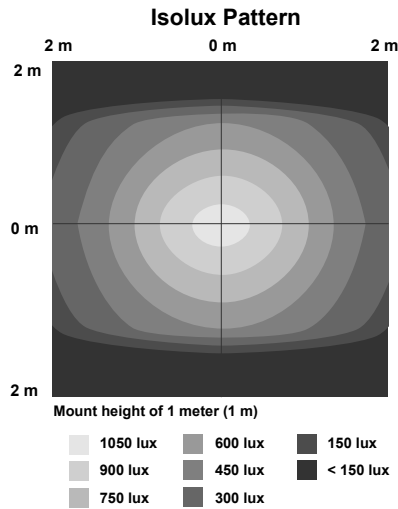
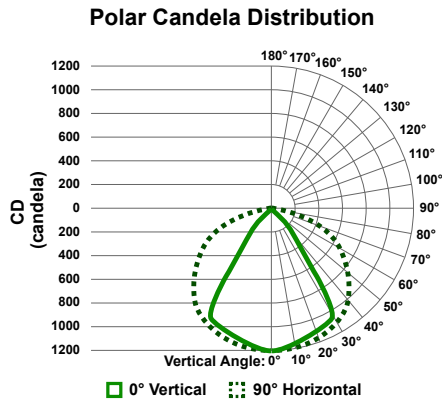

Dimensions

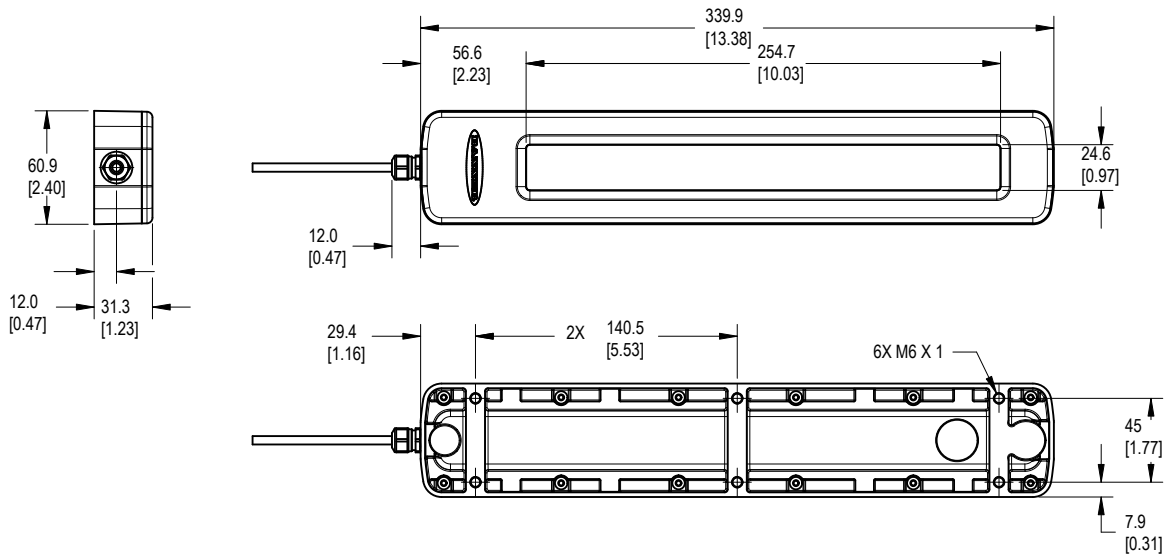

Figure 1. WLH60 (340 mm) Base Mount Side Exit Model

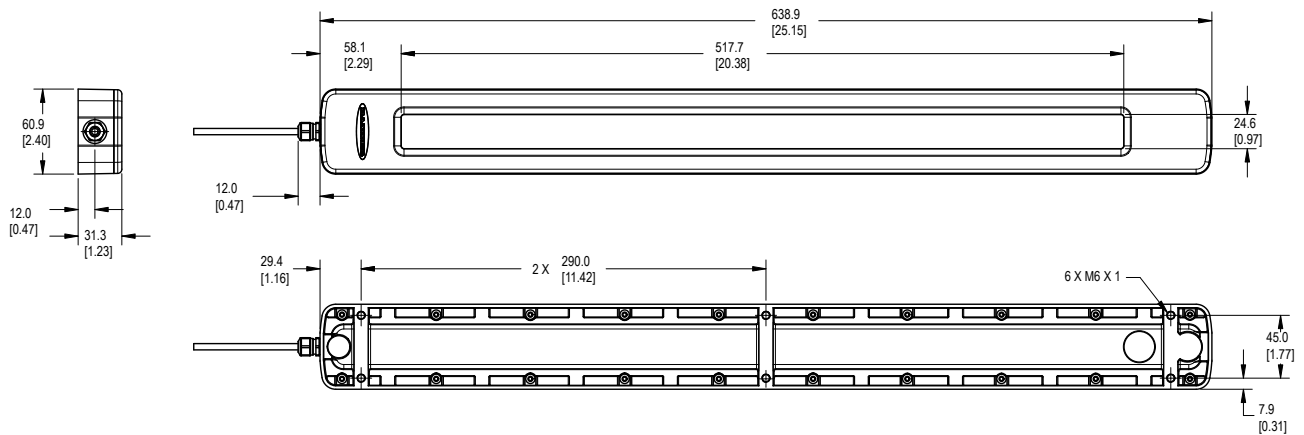

Figure 2. WLH60 (640 mm) Base Mount Side Exit Model

Accessories

Brackets

All measurements are listed in millimeters, unless noted otherwise.

LMBWLC80F

- Set of two flat brackets
- 300 series stainless steel
- Includes M6 flathead screws for mounting to light
- Clearance for M6 or 1/4-20 mounting hardware

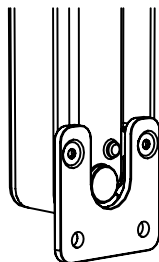

LMBWLC60RA

- Set of two right-angle brackets
- 300 series stainless steel
- Includes M6 button head screws for mounting to light
- Clearance for M6 or 1/4-20 mounting hardware

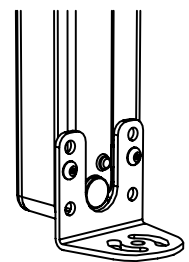

LMBWLC60MAG

- Magnetic mounting kit (set of two)
- Two inch magnets
- Mounting hardware included

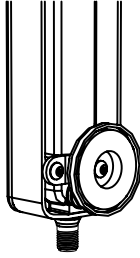

LMBWLC60RAS

- Pair of two swivel mount, right-angle brackets
- 300 series stainless steel
- Includes hardware for mounting to light

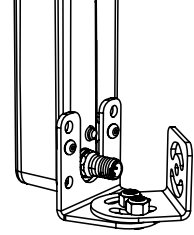

LMBWLC60B340

- Plate for sealing the cavity on the back of the 340 mm models
- 300 series stainless steel
- Includes hardware for mounting to the light

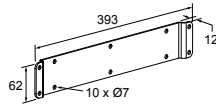

ACC-WLC60-340-GSK-FDA-1

- Blue FDA-approved silicone gasket
- Thickness: 1.6 mm

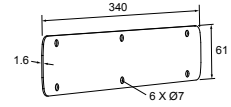

Banner Engineering Corp. Limited Warranty

Banner Engineering Corp. warrants its products to be free from defects in material and workmanship for one year following the date of shipment. Banner Engineering Corp. will repair or replace, free of charge, any product of its manufacture which, at the time it is returned to the factory, is found to have been defective during the warranty period. This warranty does not cover damage or liability for misuse, abuse, or the improper application or installation of the Banner product.

THIS LIMITED WARRANTY IS EXCLUSIVE AND IN LIEU OF ALL OTHER WARRANTIES WHETHER EXPRESS OR IMPLIED (INCLUDING, WITHOUT LIMITATION, ANY WARRANTY OF MERCHANTABILITY OR FITNESS FOR A PARTICULAR PURPOSE), AND WHETHER ARISING UNDER COURSE OF PERFORMANCE, COURSE OF DEALING OR TRADE USAGE.

This Warranty is exclusive and limited to repair or, at the discretion of Banner Engineering Corp., replacement. **IN NO EVENT SHALL BANNER ENGINEERING CORP. BE LIABLE TO BUYER OR ANY OTHER PERSON OR ENTITY FOR ANY EXTRA COSTS, EXPENSES, LOSSES, LOSS OF PROFITS, OR ANY INCIDENTAL, CONSEQUENTIAL OR SPECIAL DAMAGES RESULTING FROM ANY PRODUCT DEFECT OR FROM THE USE OR INABILITY TO USE THE PRODUCT, WHETHER ARISING IN CONTRACT OR WARRANTY, STATUTE, TORT, STRICT LIABILITY, NEGLIGENCE, OR OTHERWISE.**

Banner Engineering Corp. reserves the right to change, modify or improve the design of the product without assuming any obligations or liabilities relating to any product previously manufactured by Banner Engineering Corp. Any misuse, abuse, or improper application or installation of this product or use of the product for personal protection applications when the product is identified as not intended for such purposes will void the product warranty. Any modifications to this product without prior express approval by Banner Engineering Corp will void the product warranties. All specifications published in this document are subject to change; Banner reserves the right to modify product specifications or update documentation at any time. Specifications and product information in English supersede that which is provided in any other language. For the most recent version of any documentation, refer to: www.bannerengineering.com.

For patent information, see www.bannerengineering.com/patents.

Mexican Importer

Banner Engineering de México, S. de R.L. de C.V.
David Alfaro Siqueiros 103 Piso 2 Valle oriente
San Pedro Garza Garcia Nuevo León, C. P. 66269

81 8363.2714