

# RF Power Field Effect Transistors

## N-Channel Enhancement-Mode Lateral MOSFETs

Designed for CDMA base station applications with frequencies from 2110 to 2170 MHz. Can be used in Class AB and Class C for all typical cellular base station modulation formats.

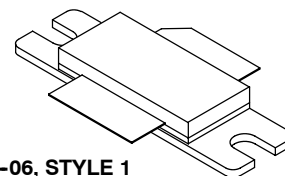
- Typical Single-Carrier W-CDMA Performance:  $V_{DD} = 28$  Volts,  $I_{DQ} = 1400$  mA,  $P_{out} = 63$  Watts Avg.,  $f = 2167.5$  MHz, IQ Magnitude Clipping, Channel Bandwidth = 3.84 MHz, Input Signal PAR = 7.5 dB @ 0.01% Probability on CCDF.  
 Power Gain — 18.5 dB  
 Drain Efficiency — 29%  
 Device Output Signal PAR — 5.9 dB @ 0.01% Probability on CCDF  
 ACPR @ 5 MHz Offset — -33 dBc in 3.84 MHz Channel Bandwidth
- Capable of Handling 5:1 VSWR, @ 32 Vdc, 2140 MHz, 190 Watts CW Output Power
- Typical  $P_{out}$  @ 1 dB Compression Point  $\approx 190$  Watts CW

### Features

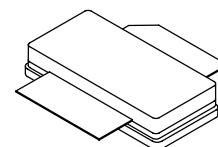
- 100% PAR Tested for Guaranteed Output Power Capability
- Characterized with Series Equivalent Large-Signal Impedance Parameters
- Internally Matched for Ease of Use
- Integrated ESD Protection
- Greater Negative Gate-Source Voltage Range for Improved Class C Operation
- Designed for Digital Predistortion Error Correction Systems
- RoHS Compliant
- In Tape and Reel. R3 Suffix = 250 Units, 56 mm Tape Width, 13 inch Reel.

**MRF7S21210HR3**  
**MRF7S21210HSR3**

**2110-2170 MHz, 63 W AVG., 28 V**  
**SINGLE W-CDMA**  
**LATERAL N-CHANNEL**  
**RF POWER MOSFETs**



**CASE 465-06, STYLE 1**  
**NI-780**  
**MRF7S21210HR3**



**CASE 465A-06, STYLE 1**  
**NI-780S**  
**MRF7S21210HSR3**

**Table 1. Maximum Ratings**

Rating	Symbol	Value	Unit
Drain-Source Voltage	$V_{DSS}$	-0.5, +65	Vdc
Gate-Source Voltage	$V_{GS}$	-6.0, +10	Vdc
Operating Voltage	$V_{DD}$	32, +0	Vdc
Storage Temperature Range	$T_{stg}$	-65 to +150	°C
Case Operating Temperature	$T_C$	150	°C
Operating Junction Temperature (1,2)	$T_J$	225	°C
CW Operation @ $T_C = 25^\circ\text{C}$ Derate above 25°C	CW	253 1.5	W W/°C

**Table 2. Thermal Characteristics**

Characteristic	Symbol	Value (2,3)	Unit
Thermal Resistance, Junction to Case Case Temperature 80°C, 190 W CW Case Temperature 72°C, 63 W CW	$R_{\theta JC}$	0.33 0.37	°C/W

1. Continuous use at maximum temperature will affect MTTF.
2. MTTF calculator available at <http://www.freescale.com/rf>. Select Software & Tools/Development Tools/Calculators to access MTTF calculators by product.
3. Refer to AN1955, *Thermal Measurement Methodology of RF Power Amplifiers*. Go to <http://www.freescale.com/rf>. Select Documentation/Application Notes - AN1955.

**Table 3. ESD Protection Characteristics**

Test Methodology	Class
Human Body Model (per JESD22-A114)	1C (Minimum)
Machine Model (per EIA/JESD22-A115)	A (Minimum)
Charge Device Model (per JESD22-C101)	IV (Minimum)

**Table 4. Electrical Characteristics** ( $T_A = 25^\circ\text{C}$  unless otherwise noted)

Characteristic	Symbol	Min	Typ	Max	Unit
----------------	--------	-----	-----	-----	------

**Off Characteristics**

Zero Gate Voltage Drain Leakage Current ( $V_{DS} = 65\text{ Vdc}$ , $V_{GS} = 0\text{ Vdc}$ )	$I_{DSS}$	—	—	10	$\mu\text{Adc}$
Zero Gate Voltage Drain Leakage Current ( $V_{DS} = 28\text{ Vdc}$ , $V_{GS} = 0\text{ Vdc}$ )	$I_{DSS}$	—	—	1	$\mu\text{Adc}$
Gate-Source Leakage Current ( $V_{GS} = 5\text{ Vdc}$ , $V_{DS} = 0\text{ Vdc}$ )	$I_{GSS}$	—	—	1	$\mu\text{Adc}$

**On Characteristics**

Gate Threshold Voltage ( $V_{DS} = 10\text{ Vdc}$ , $I_D = 513\ \mu\text{Adc}$ )	$V_{GS(th)}$	1.2	2	2.7	Vdc
Gate Quiescent Voltage ( $V_{DS} = 28\text{ Vdc}$ , $I_D = 1400\text{ mAdc}$ )	$V_{GS(Q)}$	—	2.7	—	Vdc
Fixture Gate Quiescent Voltage (1) ( $V_{DD} = 28\text{ Vdc}$ , $I_D = 1400\text{ mAdc}$ , Measured in Functional Test)	$V_{GG(Q)}$	4	5.4	7	Vdc
Drain-Source On-Voltage ( $V_{GS} = 10\text{ Vdc}$ , $I_D = 5.13\text{ Adc}$ )	$V_{DS(on)}$	0.1	0.2	0.3	Vdc

**Dynamic Characteristics (2)**

Reverse Transfer Capacitance ( $V_{DS} = 28\text{ Vdc} \pm 30\text{ mV(rms)ac}$ @ 1 MHz, $V_{GS} = 0\text{ Vdc}$ )	$C_{rss}$	—	2.02	—	pF
Output Capacitance ( $V_{DS} = 28\text{ Vdc} \pm 30\text{ mV(rms)ac}$ @ 1 MHz, $V_{GS} = 0\text{ Vdc}$ )	$C_{oss}$	—	257	—	pF
Input Capacitance ( $V_{DS} = 28\text{ Vdc}$ , $V_{GS} = 0\text{ Vdc} \pm 30\text{ mV(rms)ac}$ @ 1 MHz)	$C_{iss}$	—	516	—	pF

**Functional Tests** (In Freescale Test Fixture, 50 ohm system)  $V_{DD} = 28\text{ Vdc}$ ,  $I_{DQ} = 1400\text{ mA}$ ,  $P_{out} = 63\text{ W Avg.}$ ,  $f = 2167.5\text{ MHz}$ , Single-Carrier W-CDMA, IQ Magnitude Clipping, Input Signal PAR = 7.5 dB @ 0.01% Probability on CCDF. ACPR measured in 3.84 MHz Channel Bandwidth @  $\pm 5\text{ MHz}$  Offset.

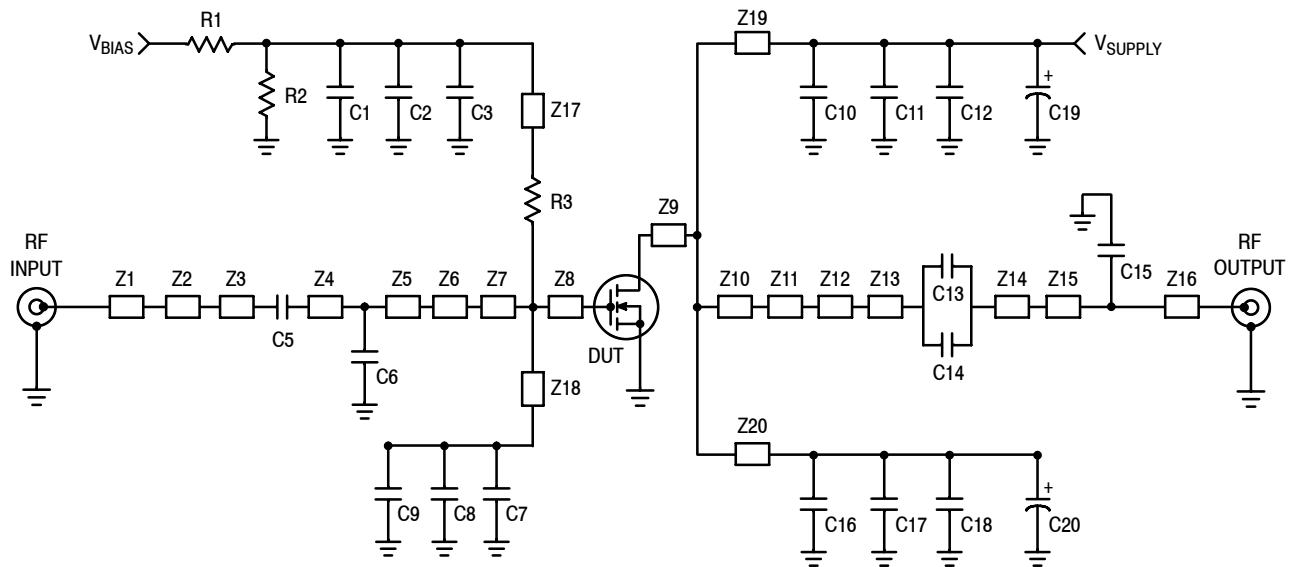
Power Gain	$G_{ps}$	17	18.5	20.5	dB
Drain Efficiency	$\eta_D$	26	29	—	%
Output Peak-to-Average Ratio @ 0.01% Probability on CCDF	PAR	5.5	5.9	—	dB
Adjacent Channel Power Ratio	ACPR	—	-33	-31	dBc
Input Return Loss	IRL	—	-15	-8	dB

- $V_{GG} = 2 \times V_{GS(Q)}$ . Parameter measured on Freescale Test Fixture, due to resistive divider network on the board. Refer to Test Circuit schematic.
- Part internally matched both on input and output.

(continued)

**Table 4. Electrical Characteristics** ( $T_A = 25^\circ\text{C}$  unless otherwise noted) **(continued)**

Characteristic	Symbol	Min	Typ	Max	Unit
<b>Typical Performances</b> (In Freescale Test Fixture, 50 ohm system) $V_{DD} = 28\text{ Vdc}$ , $I_{DQ} = 1400\text{ mA}$ , 2110–2170 MHz Bandwidth					
IMD Symmetry @ 130 W PEP, $P_{out}$ where IMD Third Order Intermodulation $\cong 30\text{ dBc}$ (Delta IMD Third Order Intermodulation between Upper and Lower Sidebands $> 2\text{ dB}$ )	$IMD_{sym}$	—	15	—	MHz
VBW Resonance Point (IMD Third Order Intermodulation Inflection Point)	$VBW_{res}$	—	60	—	MHz
Gain Flatness in 60 MHz Bandwidth @ $P_{out} = 63\text{ W Avg.}$	$G_F$	—	1.2	—	dB
Average Deviation from Linear Phase in 60 MHz Bandwidth @ $P_{out} = 190\text{ W CW}$	$\Phi$	—	1.1	—	°
Average Group Delay @ $P_{out} = 190\text{ W CW}$ , $f = 2140\text{ MHz}$	Delay	—	2.5	—	ns
Part-to-Part Insertion Phase Variation @ $P_{out} = 190\text{ W CW}$ , $f = 2140\text{ MHz}$ , Six Sigma Window	$\Delta\Phi$	—	26	—	°
Gain Variation over Temperature ( $-30^\circ\text{C}$ to $+85^\circ\text{C}$ )	$\Delta G$	—	0.019	—	dB/°C
Output Power Variation over Temperature ( $-30^\circ\text{C}$ to $+85^\circ\text{C}$ )	$\Delta P_{1dB}$	—	0.011	—	dB/°C



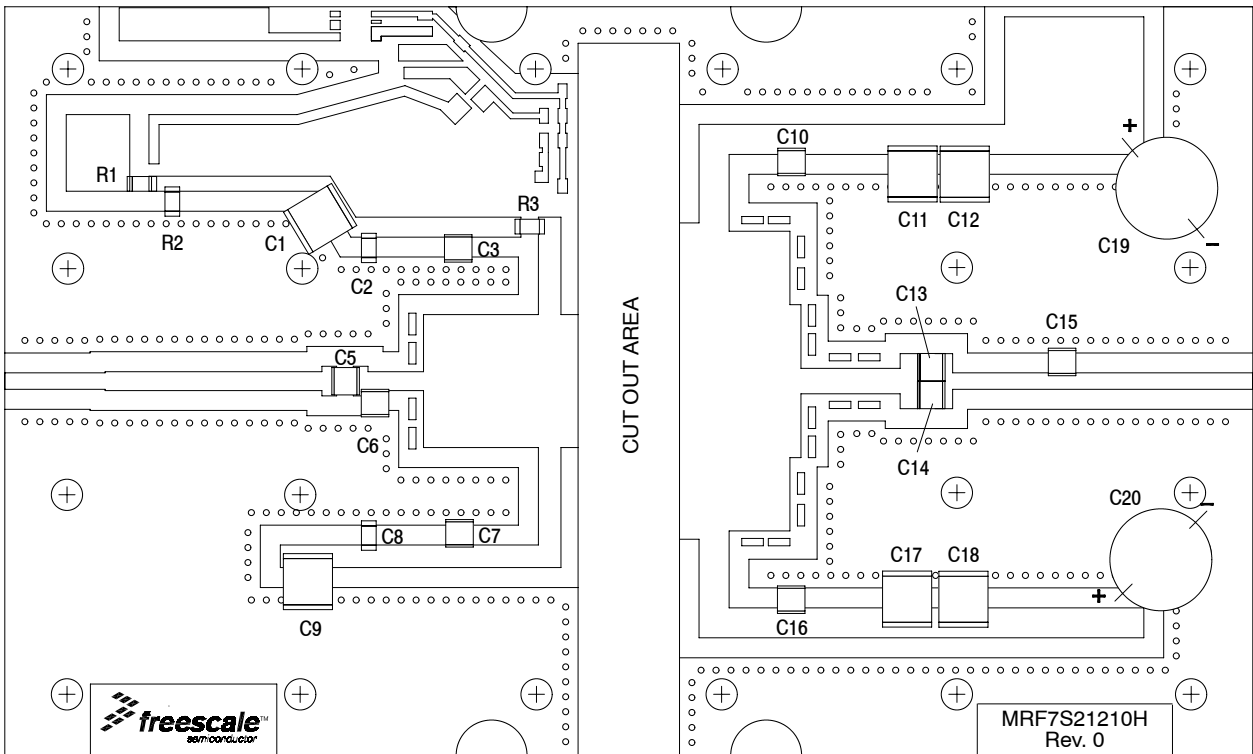
Z1	0.402" x 0.066" Microstrip	Z11	0.044" x 0.613" Microstrip
Z2	0.840" x 0.076" Microstrip	Z12	0.398" x 0.102" Microstrip
Z3	0.059" x 0.118" Microstrip	Z13	0.071" x 0.220" Microstrip
Z4	0.059" x 0.118" Microstrip	Z14	0.071" x 0.220" Microstrip
Z5	0.029" x 0.076" Microstrip	Z15	0.439" x 0.066" Microstrip
Z6	0.194" x 0.076" Microstrip	Z16	0.764" x 0.066" Microstrip
Z7	0.051" x 0.533" Microstrip	Z17	0.353" x 0.090" Microstrip
Z8	0.114" x 0.533" Microstrip	Z18	0.797" x 0.090" Microstrip
Z9	0.139" x 1.268" Microstrip	Z19, Z20	0.660" x 0.120" Microstrip
Z10	0.304" x 1.201" Microstrip	PCB	Taconic RF35, 0.030", $\epsilon_r = 3.5$

**Figure 1. Test Circuit Schematic — MRF7S21210HR3**

**Table 5. Test Circuit Component Designations and Values — MRF7S21210HR3**

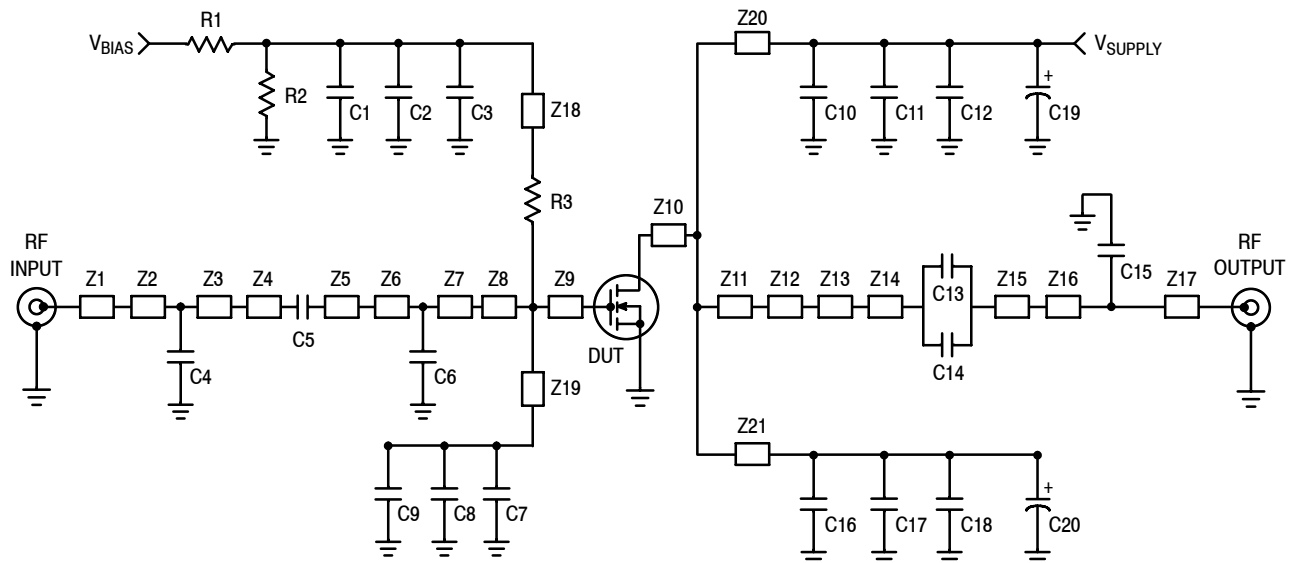
Part	Description	Part Number	Manufacturer
C1, C9, C11, C12, C17, C18	10 $\mu$ F, 50 V Chip Capacitors	C5750X5R1H106MT	TDK
C2, C8	100 nF Chip Capacitors	12065C104KAT	AVX
C3, C7, C10, C13, C14, C16	6.8 pF Chip Capacitors	ATC100B6R8BT500XT	ATC
C5	5.6 pF Chip Capacitor	ATC100B5R6BT500XT	ATC
C6	0.8 pF Chip Capacitor	ATC100B0R8BT500XT	ATC
C15	0.6 pF Chip Capacitor	ATC100B0R6BT500XT	ATC
C19, C20	470 $\mu$ F Electrolytic Capacitors	2222 12018471	BC Components
R1, R2	10 K $\Omega$ , 1/4 W Chip Resistors	WCR120610KL	Welwyn
R3	10 $\Omega$ , 1/4 W Chip Resistor	232272461009	Phycomp

C4 not used in MRF7S21210HR3 part.



C4 not used in MRF7S21210HR3 part.

**Figure 2. Test Circuit Component Layout — MRF7S21210HR3**



Z1	0.402" x 0.066" Microstrip	Z12	0.044" x 0.613" Microstrip
Z2	0.840" x 0.076" Microstrip	Z13	0.398" x 0.102" Microstrip
Z3	0.029" x 0.076" Microstrip	Z14	0.071" x 0.220" Microstrip
Z4	0.059" x 0.118" Microstrip	Z15	0.071" x 0.220" Microstrip
Z5	0.059" x 0.118" Microstrip	Z16	0.439" x 0.066" Microstrip
Z6	0.029" x 0.076" Microstrip	Z17	0.764" x 0.066" Microstrip
Z7	0.194" x 0.076" Microstrip	Z18	0.353" x 0.090" Microstrip
Z8	0.510" x 0.533" Microstrip	Z19	0.797" x 0.090" Microstrip
Z9	0.114" x 0.533" Microstrip	Z20, Z21	0.660" x 0.120" Microstrip
Z10	0.139" x 1.268" Microstrip	PCB	Taconic RF35, 0.030", $\epsilon_r = 3.5$
Z11	0.304" x 1.201" Microstrip		

**Figure 3. Test Circuit Schematic — MRF7S21210HSR3**

**Table 6. Test Circuit Component Designations and Values — MRF7S21210HSR3**

Part	Description	Part Number	Manufacturer
C1, C9, C11, C12, C17, C18	10 $\mu$ F, 50 V Chip Capacitors	C5750X5R1H106MT	TDK
C2, C8	100 nF Chip Capacitors	12065C104KAT	AVX
C3, C7, C10, C13, C14, C16	6.8 pF Chip Capacitors	ATC100B6R8BT500XT	ATC
C4	0.3 pF Chip Capacitor	ATC100B0R3BT500XT	ATC
C5	5.6 pF Chip Capacitor	ATC100B5R6BT500XT	ATC
C6	0.2 pF Chip Capacitor	ATC100B0R2BT500XT	ATC
C15	0.4 pF Chip Capacitor	ATC100B0R4BT500XT	ATC
C19, C20	470 $\mu$ F Electrolytic Capacitors	2222 12018471	BC Components
R1, R2	10 K $\Omega$ , 1/4 W Chip Resistors	WCR120610KL	Welwyn
R3	10 $\Omega$ , 1/4 W Chip Resistor	232272461009	Phycomp

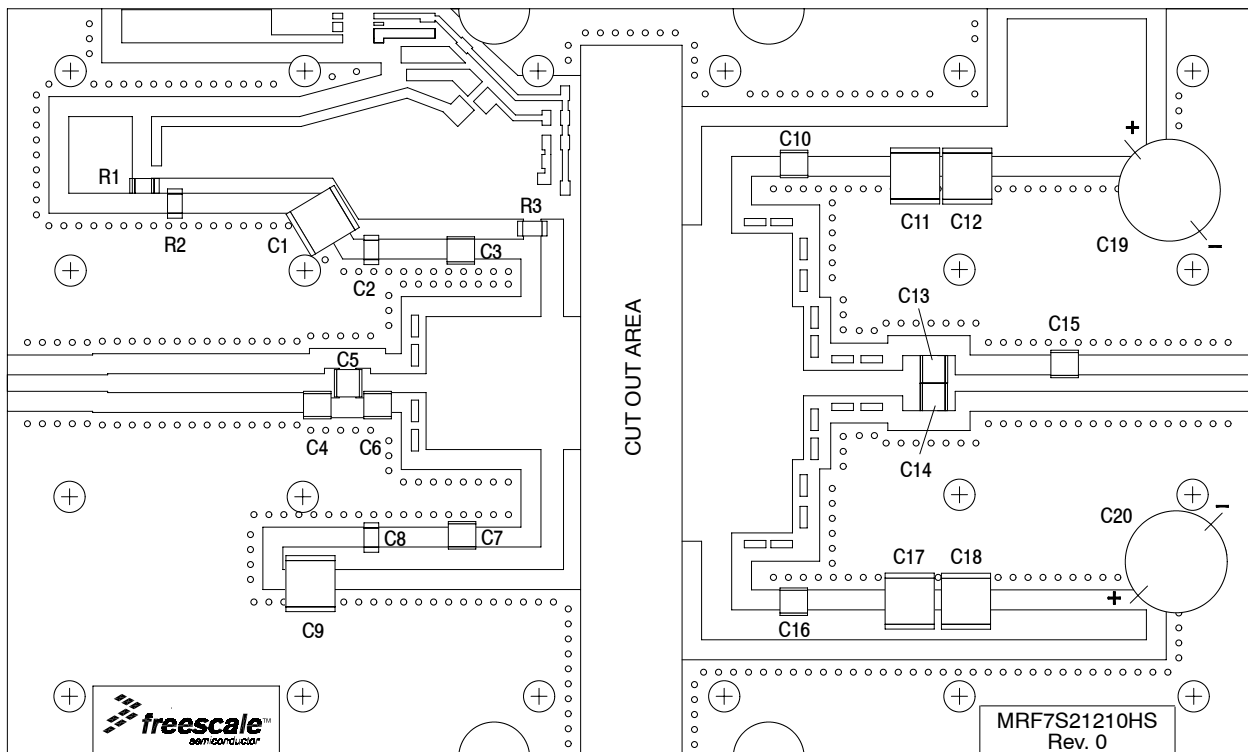
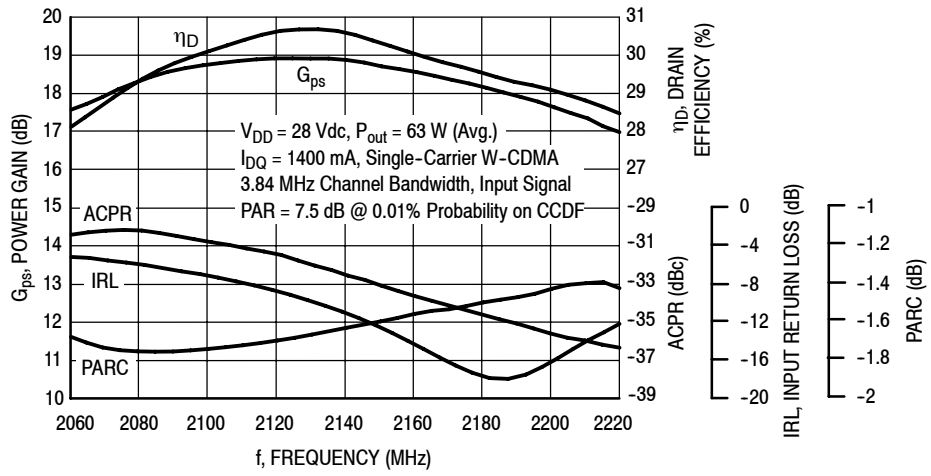


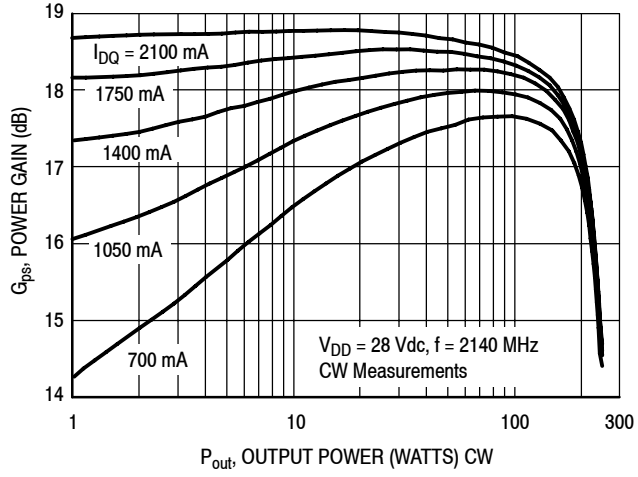
Figure 4. Test Circuit Component Layout — MRF7S21210HSR3

### TYPICAL CHARACTERISTICS

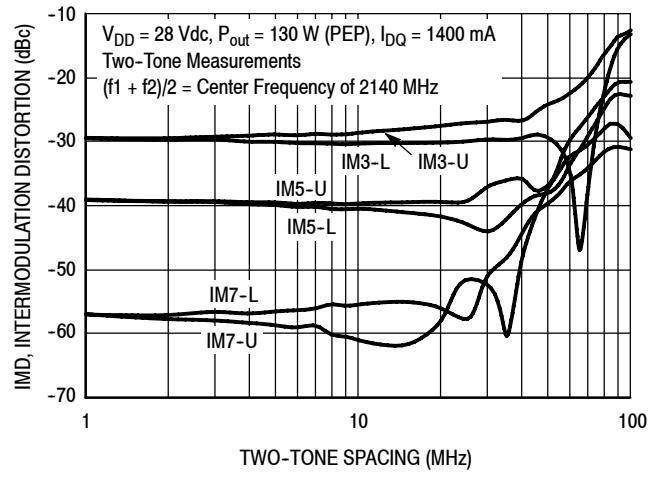


Note: Measurement conducted with device soldered on Freescale test fixture.

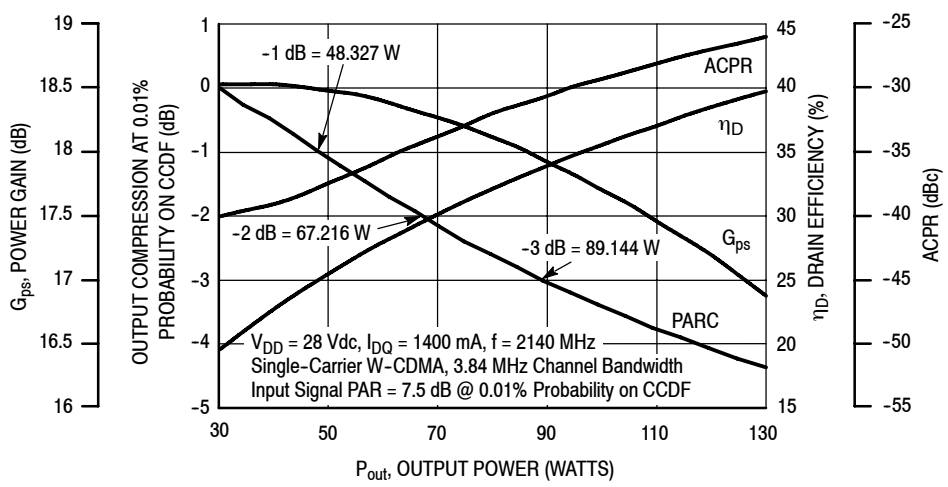
**Figure 5. Output Peak-to-Average Ratio Compression (PARC) Broadband Performance @ P<sub>out</sub> = 63 Watts Avg.**



**Figure 6. CW Power Gain versus Output Power**



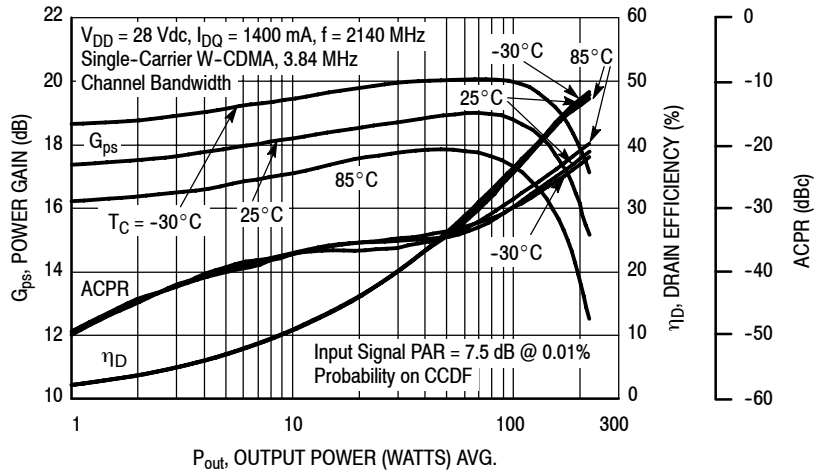
**Figure 7. Intermodulation Distortion Products versus Tone Spacing**



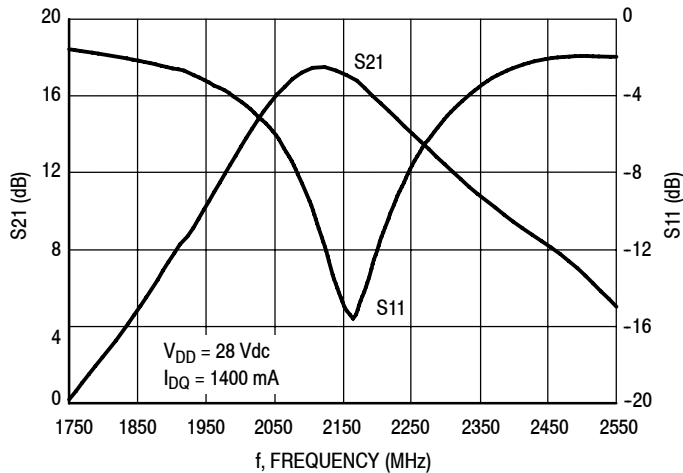
**Figure 8. Output Peak-to-Average Ratio Compression (PARC) versus Output Power**



### TYPICAL CHARACTERISTICS

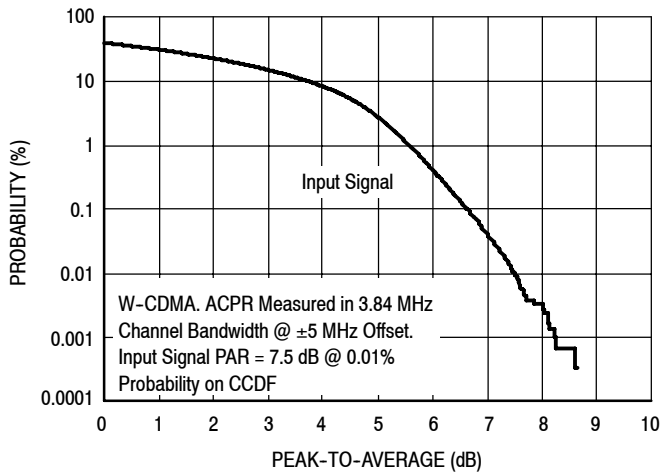


**Figure 9. Single-Carrier W-CDMA Power Gain, Drain Efficiency and ACPR versus Output Power**

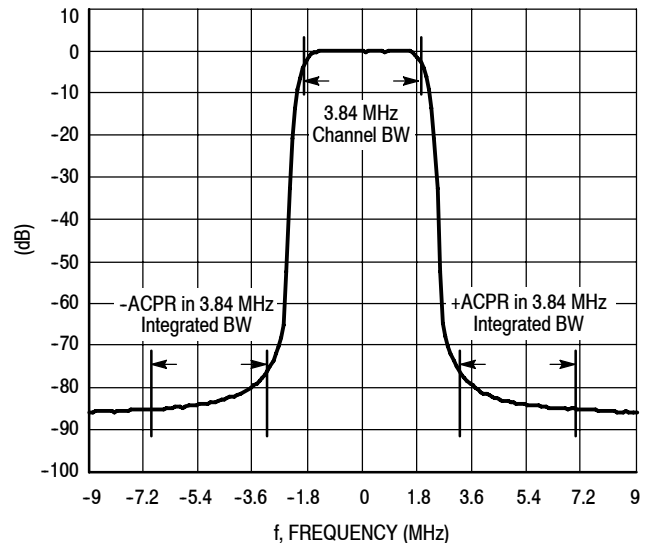


**Figure 10. Broadband Frequency Response**

### W-CDMA TEST SIGNAL

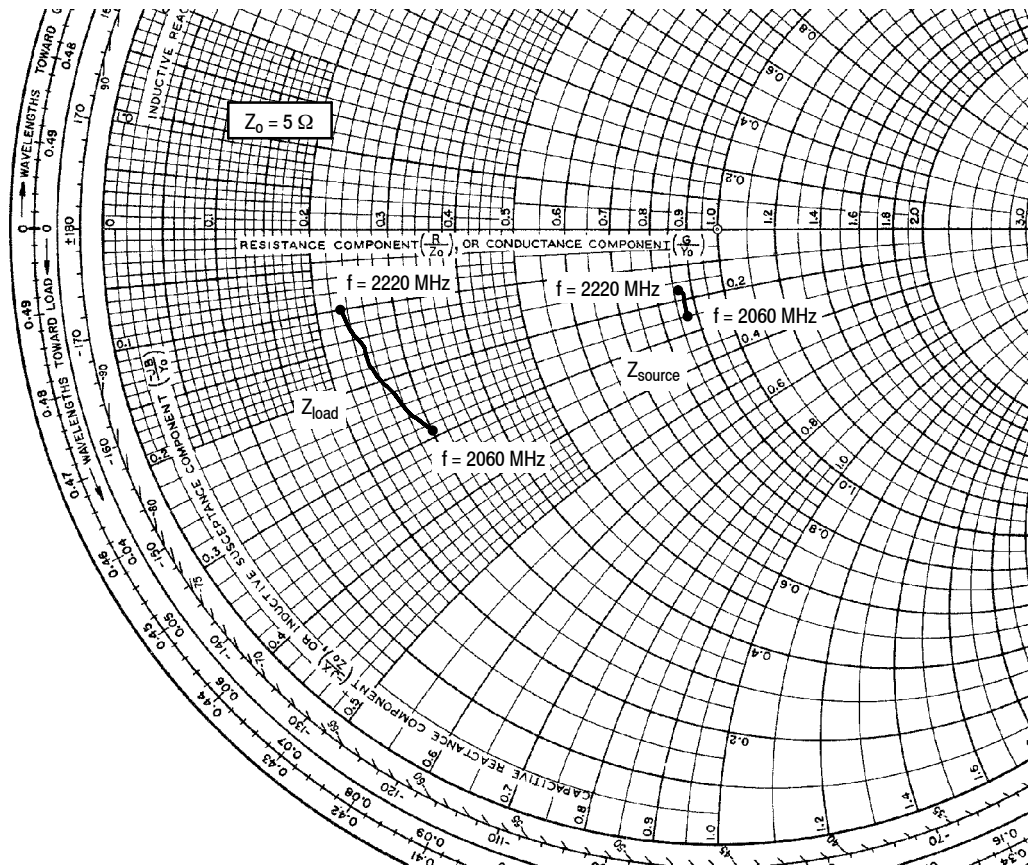


**Figure 11. CCDF W-CDMA IQ Magnitude Clipping, Single-Carrier Test Signal**



**Figure 12. Single-Carrier W-CDMA Spectrum**

MRF7S21210HR3 MRF7S21210HSR3



$V_{DD} = 28 \text{ Vdc}$ ,  $I_{DQ} = 1400 \text{ mA}$ ,  $P_{out} = 63 \text{ W Avg.}$

f MHz	$Z_{source}$ $\Omega$	$Z_{load}$ $\Omega$
2060	$4.34 - j1.26$	$1.52 - j1.46$
2080	$4.34 - j1.20$	$1.47 - j1.35$
2100	$4.34 - j1.14$	$1.42 - j1.23$
2120	$4.33 - j1.09$	$1.37 - j1.11$
2140	$4.34 - j1.05$	$1.32 - j0.99$
2160	$4.33 - j0.96$	$1.27 - j0.87$
2180	$4.33 - j0.92$	$1.23 - j0.75$
2200	$4.33 - j0.92$	$1.19 - j0.64$
2220	$4.32 - j0.87$	$1.15 - j0.52$

$Z_{source}$  = Test circuit impedance as measured from gate to ground.

$Z_{load}$  = Test circuit impedance as measured from drain to ground.

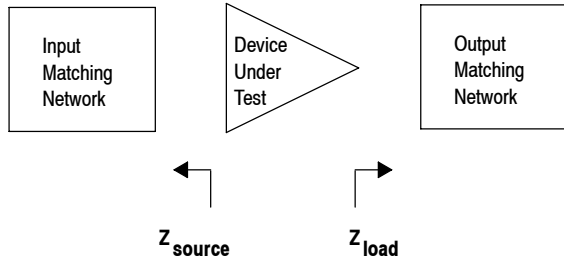
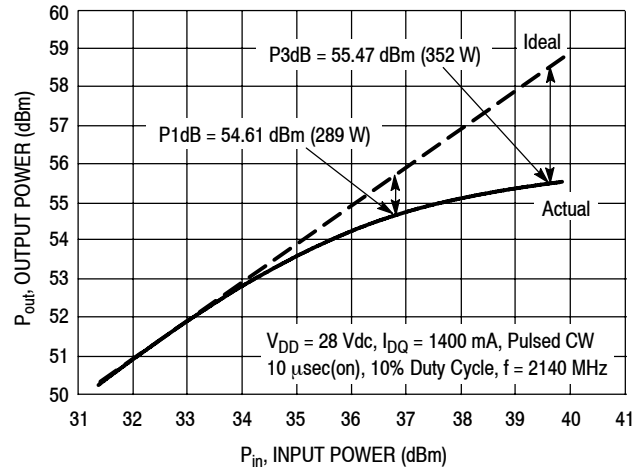


Figure 13. Series Equivalent Source and Load Impedance

## ALTERNATIVE PEAK TUNE LOAD PULL CHARACTERISTICS



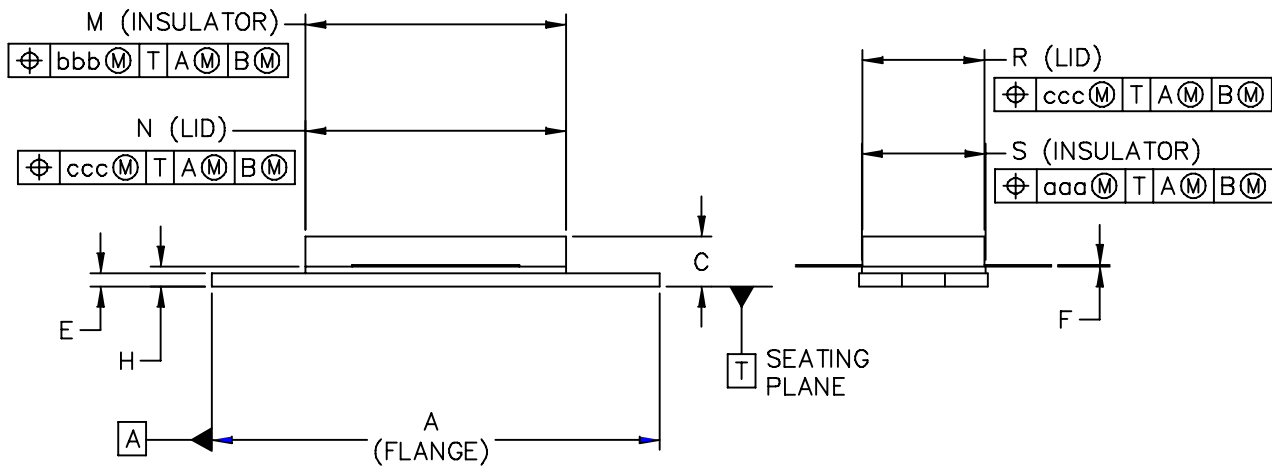
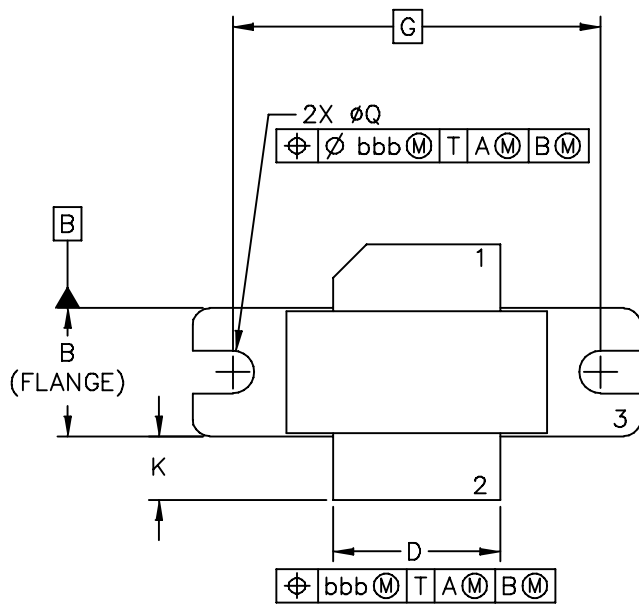
NOTE: Load Pull Test Fixture Tuned for Peak P1dB Output Power @ 28 V

Test Impedances per Compression Level

	$Z_{source}$ $\Omega$	$Z_{load}$ $\Omega$
P1dB	5.21 - j0.31	1.23 - j1.06

Figure 14. Pulsed CW Output Power versus Input Power @ 28 V

### PACKAGE DIMENSIONS



© FREESCALE SEMICONDUCTOR, INC. ALL RIGHTS RESERVED.	MECHANICAL OUTLINE	PRINT VERSION NOT TO SCALE	
TITLE:  NI-780	DOCUMENT NO: 98ASB15607C		REV: G
	CASE NUMBER: 465-06		31 MAR 2005
	STANDARD: NON-JEDEC		

NOTES:

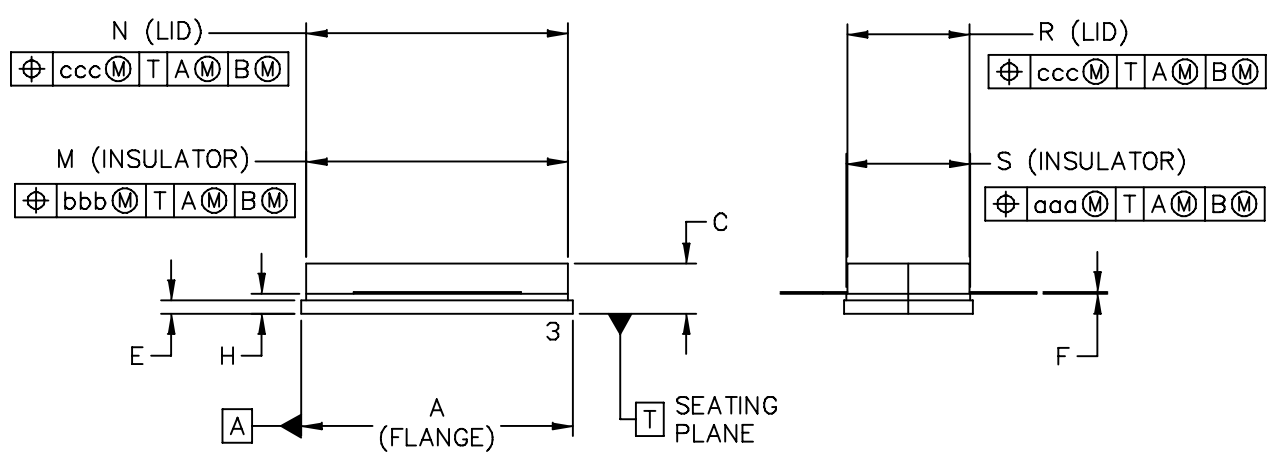
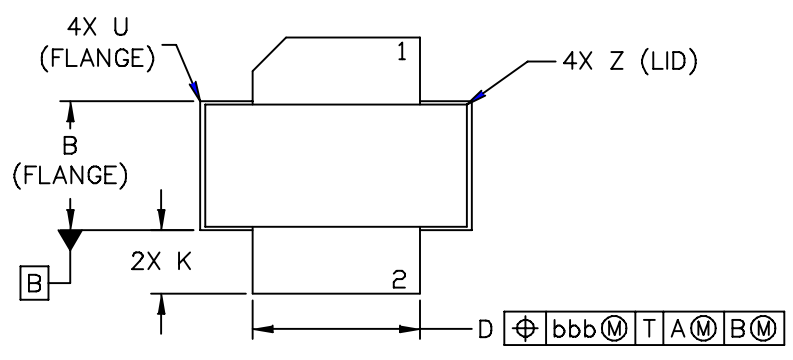
1. DIMENSIONING AND TOLERANCING PER ANSI Y14.5M-1994.
2. CONTROLLING DIMENSION: INCH.
3. DELETED
4. DIMENSION H IS MEASURED .030 (.762) AWAY FROM PACKAGE BODY.

STYLE 1:

- PIN 1. DRAIN  
 2. GATE  
 3. SOURCE

DIM	INCH		MILLIMETER		DIM	INCH		MILLIMETER	
	MIN	MAX	MIN	MAX		MIN	MAX	MIN	MAX
A	1.335	1.345	33.91	34.16	R	.365	.375	9.27	9.53
B	.380	.390	9.65	9.91	S	.365	.375	9.27	9.52
C	.125	.170	3.18	4.32	aaa	—	.005	—	0.127
D	.495	.505	12.57	12.83	bbb	—	.010	—	0.254
E	.035	.045	0.89	1.14	ccc	—	.015	—	0.381
F	.003	.006	0.08	0.15	—	—	—	—	—
G	1.100 BSC		27.94 BSC		—	—	—	—	—
H	.057	.067	1.45	1.7	—	—	—	—	—
K	.170	.210	4.32	5.33	—	—	—	—	—
M	.774	.786	19.66	19.96	—	—	—	—	—
N	.772	.788	19.6	20	—	—	—	—	—
Q	∅.118	∅.138	∅3	∅3.51	—	—	—	—	—

© FREESCALE SEMICONDUCTOR, INC. ALL RIGHTS RESERVED.	MECHANICAL OUTLINE	PRINT VERSION NOT TO SCALE
TITLE:  NI-780	DOCUMENT NO: 98ASB15607C CASE NUMBER: 465-06 STANDARD: NON-JEDEC	REV: G 31 MAR 2005



© FREESCALE SEMICONDUCTOR, INC. ALL RIGHTS RESERVED.	MECHANICAL OUTLINE	PRINT VERSION NOT TO SCALE	
TITLE:  NI-780S	DOCUMENT NO: 98ASB16718C	REV: H	
	CASE NUMBER: 465A-06	31 MAR 2005	
	STANDARD: NON-JEDEC		

NOTES:

1. DIMENSIONING AND TOLERANCING PER ANSI Y14.5M-1994.
2. CONTROLLING DIMENSION: INCH.
3. DELETED
4. DIMENSION H IS MEASURED .030 (0.762) AWAY FROM PACKAGE BODY.

STYLE 1:

- PIN 1. DRAIN
- 2. GATE
- 3. SOURCE

DIM	INCH		MILLIMETER		DIM	INCH		MILLIMETER	
	MIN	MAX	MIN	MAX		MIN	MAX	MIN	MAX
A	.805	-.815	20.45	20.7	U	-.040	-	-	1.02
B	.380	-.390	9.65	9.91	Z	-.030	-	-	0.76
C	.125	-.170	3.18	4.32	aaa	-.005	-	-	0.127
D	.495	-.505	12.57	12.83	bbb	-.010	-	-	0.254
E	.035	-.045	0.89	1.14	ccc	-.015	-	-	0.381
F	.003	-.006	0.08	0.15	-	-	-	-	-
H	.057	-.067	1.45	1.7	-	-	-	-	-
K	.170	-.210	4.32	5.33	-	-	-	-	-
M	.774	-.786	19.61	20.02	-	-	-	-	-
N	.772	-.788	19.61	20.02	-	-	-	-	-
R	.365	-.375	9.27	9.53	-	-	-	-	-
S	.365	-.375	9.27	9.52	-	-	-	-	-

© FREESCALE SEMICONDUCTOR, INC. ALL RIGHTS RESERVED.		MECHANICAL OUTLINE		PRINT VERSION NOT TO SCALE	
TITLE:  NI-780S		DOCUMENT NO: 98ASB16718C		REV: H	
		CASE NUMBER: 465A-06		31 MAR 2005	
		STANDARD: NON-JEDEC			

## PRODUCT DOCUMENTATION AND SOFTWARE

Refer to the following documents and software to aid your design process.

### Application Notes

- AN1955: Thermal Measurement Methodology of RF Power Amplifiers

### Engineering Bulletins

- EB212: Using Data Sheet Impedances for RF LDMOS Devices

### Software

- Electromigration MTTF Calculator
- RF High Power Model

For Software, do a Part Number search at <http://www.freescale.com>, and select the “Part Number” link. Go to the Software & Tools tab on the part’s Product Summary page to download the respective tool.

## REVISION HISTORY

The following table summarizes revisions to this document.

Revision	Date	Description
0	July 2008	<ul style="list-style-type: none"> <li>• Initial Release of Data Sheet</li> </ul>
1	Jan. 2009	<ul style="list-style-type: none"> <li>• Added MRF7S21210HR3 part to data sheet, p. 1</li> <li>• Added Fig. 1, Test Circuit Schematic and Microstrip list for MRF7S21210HR3, p. 4</li> <li>• Added Fig. 2, Test Circuit Component Part Layout for MRF7S21210HR3, p. 5</li> <li>• Table 6, Test Circuit Component Designations and Values – MRF7S21210HR3, changed Part Number and Manufacturer for R1, R2 from CRCW12061002FKEA, Vishay to WCR120610KL, Welwyn and for R3 from CRCW12061000FKEA, Vishay to 232272461009, Phycomp, p. 6</li> <li>• Added Fig. 11, MTTF versus Junction Temperature, p. 9</li> <li>• Added 465-06 (NI-780) package isometric, p. 1, and Mechanical Outline, p. 12</li> </ul>
2	Mar. 2011	<ul style="list-style-type: none"> <li>• Modified data sheet to reflect RF Test Reduction described in Product and Process Change Notification number, PCN13628, p. 1, 2</li> <li>• Fig. 11, MTTF versus Junction Temperature removed, p. 9. Refer to the device’s MTTF Calculator available at <a href="http://freescale.com/RFpower">freescale.com/RFpower</a>. Go to Design Resources &gt; Software and Tools.</li> <li>• Fig. 12, CCDF W-CDMA IQ Magnitude Clipping, Single-Carrier Test Signal and Fig. 13, Single-Carrier W-CDMA Spectrum updated to show the undistorted input test signal, p. 10 (renumbered as Figs. 11 and 12 respectively after Fig. 11 removed)</li> <li>• Added Electromigration MTTF Calculator and RF High Power Model availability to Product Software, p. 16</li> </ul>



## **How to Reach Us:**

### **Home Page:**

[www.freescale.com](http://www.freescale.com)

### **Web Support:**

<http://www.freescale.com/support>

### **USA/Europe or Locations Not Listed:**

Freescale Semiconductor, Inc.  
Technical Information Center, EL516  
2100 East Elliot Road  
Tempe, Arizona 85284  
1-800-521-6274 or +1-480-768-2130  
[www.freescale.com/support](http://www.freescale.com/support)

### **Europe, Middle East, and Africa:**

Freescale Halbleiter Deutschland GmbH  
Technical Information Center  
Schatzbogen 7  
81829 Muenchen, Germany  
+44 1296 380 456 (English)  
+46 8 52200080 (English)  
+49 89 92103 559 (German)  
+33 1 69 35 48 48 (French)  
[www.freescale.com/support](http://www.freescale.com/support)

### **Japan:**

Freescale Semiconductor Japan Ltd.  
Headquarters  
ARCO Tower 15F  
1-8-1, Shimo-Meguro, Meguro-ku,  
Tokyo 153-0064  
Japan  
0120 191014 or +81 3 5437 9125  
[support.japan@freescale.com](mailto:support.japan@freescale.com)

### **Asia/Pacific:**

Freescale Semiconductor China Ltd.  
Exchange Building 23F  
No. 118 Jianguo Road  
Chaoyang District  
Beijing 100022  
China  
+86 10 5879 8000  
[support.asia@freescale.com](mailto:support.asia@freescale.com)

### **For Literature Requests Only:**

Freescale Semiconductor Literature Distribution Center  
1-800-441-2447 or +1-303-675-2140  
Fax: +1-303-675-2150  
[LDCForFreescaleSemiconductor@hibbertgroup.com](mailto:LDCForFreescaleSemiconductor@hibbertgroup.com)

Information in this document is provided solely to enable system and software implementers to use Freescale Semiconductor products. There are no express or implied copyright licenses granted hereunder to design or fabricate any integrated circuits or integrated circuits based on the information in this document.

Freescale Semiconductor reserves the right to make changes without further notice to any products herein. Freescale Semiconductor makes no warranty, representation or guarantee regarding the suitability of its products for any particular purpose, nor does Freescale Semiconductor assume any liability arising out of the application or use of any product or circuit, and specifically disclaims any and all liability, including without limitation consequential or incidental damages. "Typical" parameters that may be provided in Freescale Semiconductor data sheets and/or specifications can and do vary in different applications and actual performance may vary over time. All operating parameters, including "Typicals", must be validated for each customer application by customer's technical experts. Freescale Semiconductor does not convey any license under its patent rights nor the rights of others. Freescale Semiconductor products are not designed, intended, or authorized for use as components in systems intended for surgical implant into the body, or other applications intended to support or sustain life, or for any other application in which the failure of the Freescale Semiconductor product could create a situation where personal injury or death may occur. Should Buyer purchase or use Freescale Semiconductor products for any such unintended or unauthorized application, Buyer shall indemnify and hold Freescale Semiconductor and its officers, employees, subsidiaries, affiliates, and distributors harmless against all claims, costs, damages, and expenses, and reasonable attorney fees arising out of, directly or indirectly, any claim of personal injury or death associated with such unintended or unauthorized use, even if such claim alleges that Freescale Semiconductor was negligent regarding the design or manufacture of the part.

Freescale™ and the Freescale logo are trademarks of Freescale Semiconductor, Inc. All other product or service names are the property of their respective owners.

© Freescale Semiconductor, Inc. 2008-2009, 2011. All rights reserved.