

ADA-4789

Silicon Bipolar Darlington Amplifier



Data Sheet

Description

Avago Technologies' ADA-4789 is an economical, easy-to-use, general purpose silicon bipolar RFIC gain block amplifiers housed in SOT-89 surface mount plastic package.

The Darlington feedback structure provides inherent broad bandwidth performance, resulting in useful operating frequency up to 2.5 GHz. This is an ideal device for small-signal gain cascades or IF amplification.

ADA-4789 is fabricated using Avago's HP25 silicon bipolar process, which employs a double-diffused single poly-silicon process with self-aligned submicron emitter geometry. The process is capable of simultaneous high f_T and high NPN breakdown (25 GHz f_T at 6V BVCEO). The process utilizes industry standard device oxide isolation technologies and submicron aluminum multi-layer inter-connects to achieve superior performance, high uniformity, and proven reliability.

Package Marking and Pin Connections

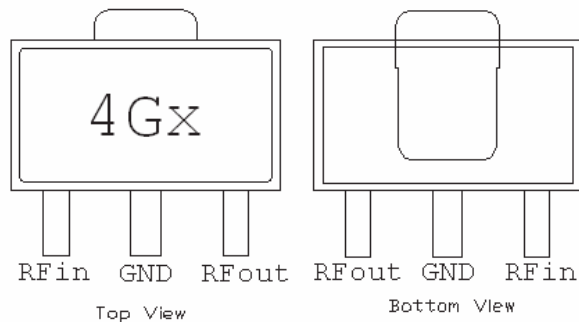

Note: Package marking provides orientation and identification

"4G" = Device Code

"x" = Month code indicates the month of manufacture

Features

- Small Signal Gain Amplifier
- Operating Frequency: DC – 2.5 GHz
- Unconditionally Stable
- 50 Ohms Input & Output
- Flat, Broadband Frequency Response up to 1 GHz
- Operating Current: 40 – 80 mA
- Industry Standard SOT-89 Package
- Single Supply
- VSWR < 2 Throughput Operating Frequency

Specifications

900MHz, 3.80V, 60mA (Typical)

- 16.50 dB Associated Gain
- 17.10 dBm P1dB
- 32.60 dBm OIP3
- 4.20 dB Noise Figure

900MHz, 4.10V, 80mA (Typical)

- 16.90 dB Associated Gain
- 18.80 dBm P1dB
- 33.20 dBm OIP3
- 4.30 dB Noise Figure

Applications

- Cellular/PCS/WLL Base Stations
- Wireless Data/WLAN
- Fiber-Optic Systems
- ISM

Typical Biasing Configuration

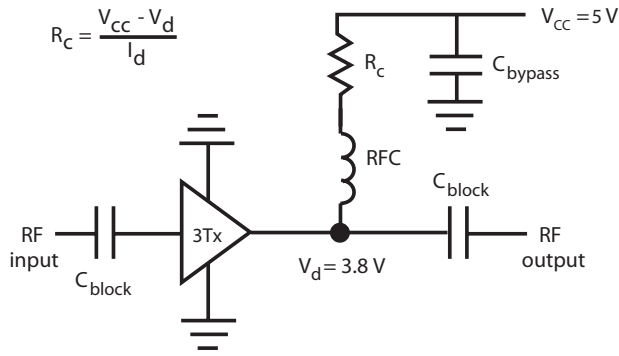

Table 1. Absolute Maximum Ratings ^[1] at T_c = +25°C

Symbol	Parameter	Unit	Max Rating
I _d	Device Current	mA	90
P _{diss}	Total Power Dissipation ^[2]	mW	370
P _{in max}	RF Input Power	dBm	20
T _j	Junction Temperature	°C	150
T _{stg}	Storage Temperature	°C	-65 to 150
θ _{jc}	Thermal Resistance ^[3]	°C/W	50

Notes:

1. Operation in excess of any one of these conditions may result in permanent damage to the device.
2. Ground lead temperature is 25°C. Derate 20 mW/°C for T_c > 131.5 °C.
3. Thermal Resistance is measured from junction to board using IR method.

Table 2. Electrical Specifications at T_c = +25°C

Symbol	Parameter and Test Condition: I _d = 60mA, Z _o = 50Ω	Frequency	Units	Min.	Typ.	Max.
V _d	Device Voltage		V	3.3	3.8	4.3
G _p	Power Gain	100 MHz 900 MHz ^[1,2] 2.0 GHz	dB	15	16.9 16.5 16.2	18
G _p	Gain Flatness	100 to 900 MHz 0.1 to 2.0 GHz	dB		0.3 0.5	
F3dB	3dB Bandwidth		GHz		4	
VSWR _{in}	Input Voltage Standing Wave Ratio	0.1 to 4.0 GHz			1.3:1	
VSWR _{out}	Output Voltage Standing Wave Ratio	0.1 to 4.0 GHz			1.5:1	
NF	50Ω Noise Figure	100 MHz 900 MHz ^[1,2] 2.0 GHz	dB		4.1 4.2 4.4	
P1dB	Output Power at 1dB Gain Compression	100 MHz 900 MHz ^[1,2] 2.0 GHz	dBm	16.0	17.7 17.1 16.2	
OIP3	Output Third Order Intercept Point	100 MHz ^[3] 900 MHz ^[1,2,3] 2.0 GHz ^[3]	dBm	27	33.4 32.6 28.8	
dV/dT	Device Voltage Temperature Coefficient		mV/°C		-4.9	

Notes:

1. Typical value determined from a sample size of 500 parts from 3 wafers.
2. Measurement obtained using production test board described in the block diagram below.
3. i) 100 MHz OIP3 Test Condition: F1 = 100 MHz, F2 = 105 MHz, Pin = -20 dBm per tone.
ii) 900 MHz OIP3 Test Condition: F1 = 900 MHz, F2 = 905 MHz, Pin = -20 dBm per tone.
iii) 2000 MHz OIP3 Test Condition: F1 = 2000 MHz, F2 = 2005 MHz, Pin = -20 dBm per tone.

Table 3. Typical Electrical performance at Tc = +25°C, Id=80mA, Zo= 50 Ω

Symbol	Parameter and Test Condition:	Frequency	Units	Min.	Typ.	Max.
Vd	Device Voltage		V		4.1	
Gp	Power Gain	100 MHz 900 MHz ^[1,2] 2.0 GHz	dB		17.1 16.9 16.3	
NF	50Ω Noise Figure	100 MHz 900 MHz ^[1,2] 2.0 GHz	dB		4.1 4.3 4.5	
P1dB	Output Power at 1dB Gain Compression	100 MHz 900 MHz ^[1,2] 2.0 GHz	dBm		19.3 18.8 16.9	
OIP3	Output Third Order Intercept Point	100 MHz ^[3] 900 MHz ^[1,2,3] 2.0 GHz ^[3]	dBm		35.4 33.2 29	

Notes:

1. Typical value determined from a sample size of 200 parts from 2 wafers.
2. Measurement obtained using production test board described in the block diagram below.
3. i) 100 MHz OIP3 Test Condition: F1 = 100 MHz, F2 = 105 MHz, Pin = -20 dBm per tone.
ii) 900 MHz OIP3 Test Condition: F1 = 900 MHz, F2 = 905 MHz, Pin = -20 dBm per tone.
iii) 2000 MHz OIP3 Test Condition: F1 = 2000 MHz, F2 = 2005 MHz, Pin = -20 dBm per tone.

Block Diagram

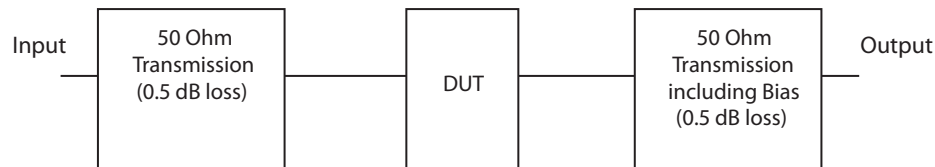

Block diagram of 900 MHz production test board used for Vd, Gain, P1dB, OIP3, and NF measurements show in table 2 & 3. Circuit losses have been de-embedded from actual measurement.

Product Consistency Distribution Charts at 900 MHz, Id=60mA

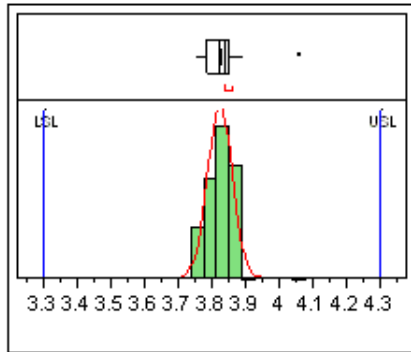

Figure 1. Vd Distribution@60mA.

LSL=3.3V, Nominal=3.8V, USL=4.3V

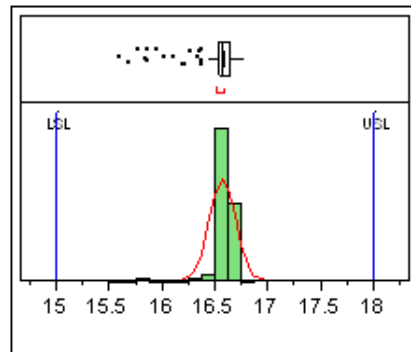

Figure 2. Gain Distribution@60mA.

LSL=15 dB, Nominal=16.5 dB, USL=18 dB

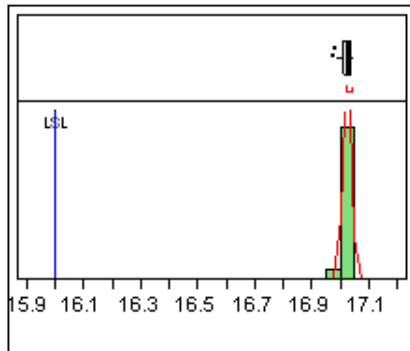

Figure 3. P1dB Distribution@60mA

LSL=16.0 dBm, Nominal=17.1dBm

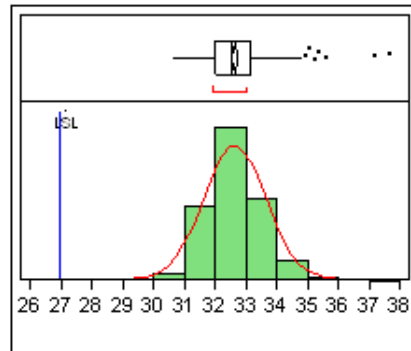

Figure 4. OIP3 Distribution@60mA.

LSL=27 dBm, Nominal=32.6 dBm

Notes:

1. Statistics distribution determined from a sample size of 500 parts taken from 3 different wafers.
2. Future wafers allocated to this product may have typical values anywhere between the minimum and maximum specification limits.

Typical Performance Curve (at Tc=25°C, unless specified otherwise)

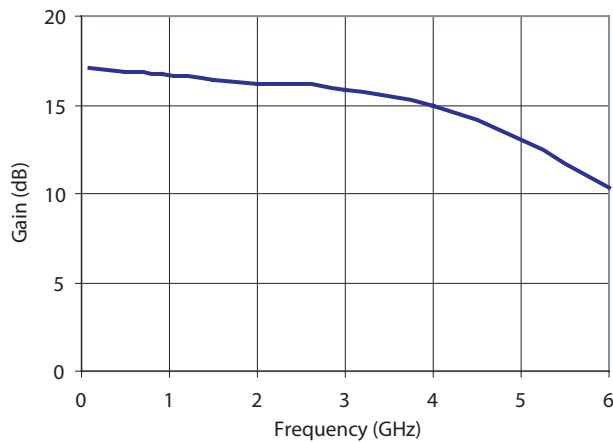

Figure 5. Gain vs Frequency at Id = 60 mA.

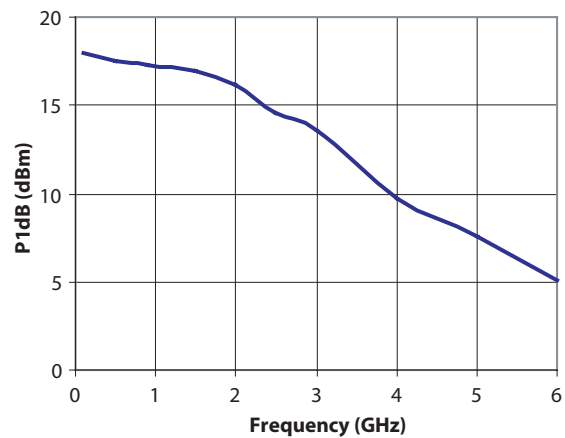

Figure 6. P1dB vs Frequency at Id = 60 mA.

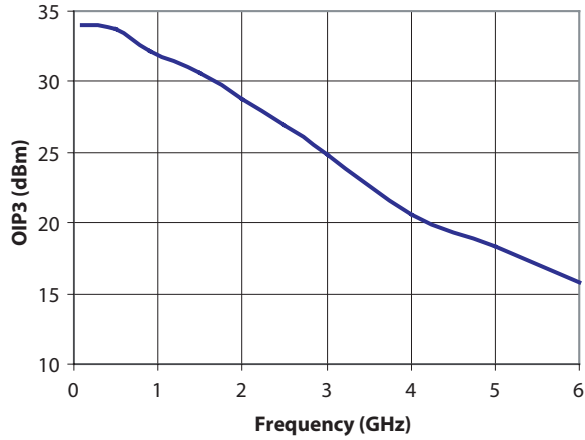

Figure 7. OIP3 vs Frequency at $I_d = 60$ mA.

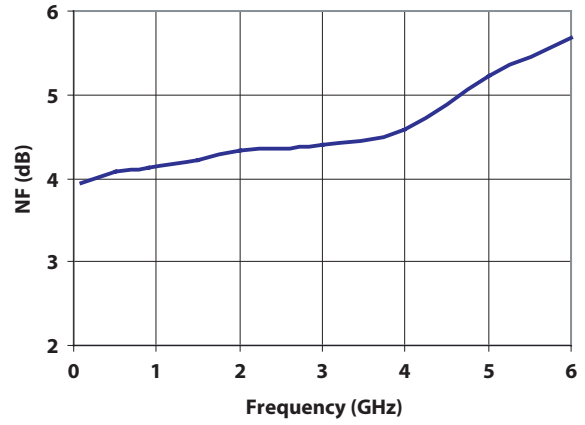

Figure 8. NF vs Frequency at $I_d = 60$ mA.

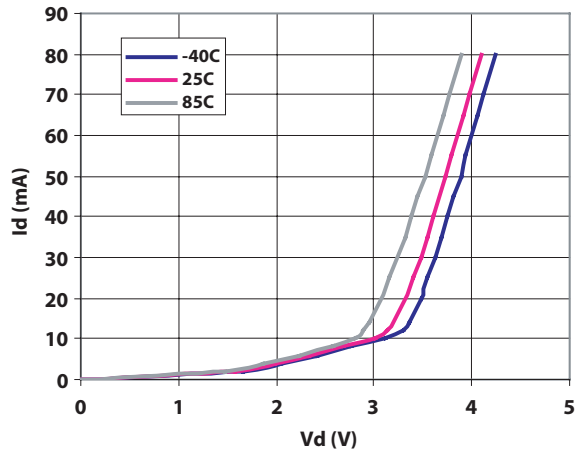

Figure 9. I_d vs. V_d and Temperature.

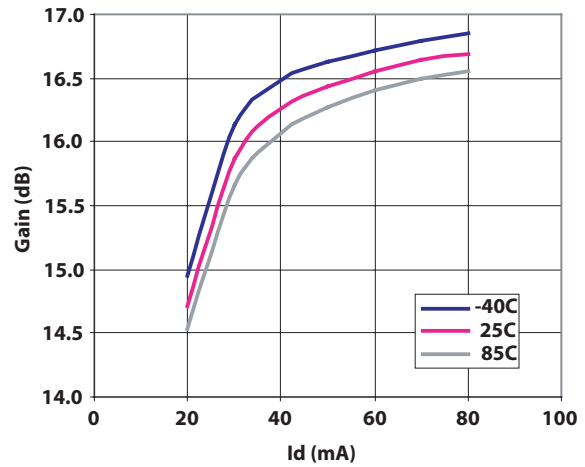

Figure 10. Gain vs. I_d and Temperature at 900 MHz.

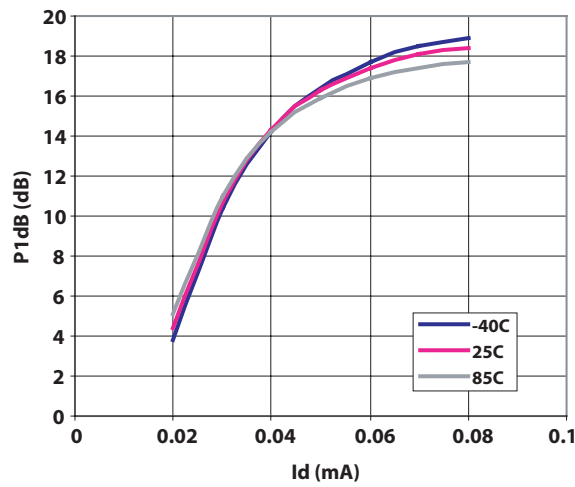

Figure 11. P1dB vs. I_d and Temperature at 900 MHz.

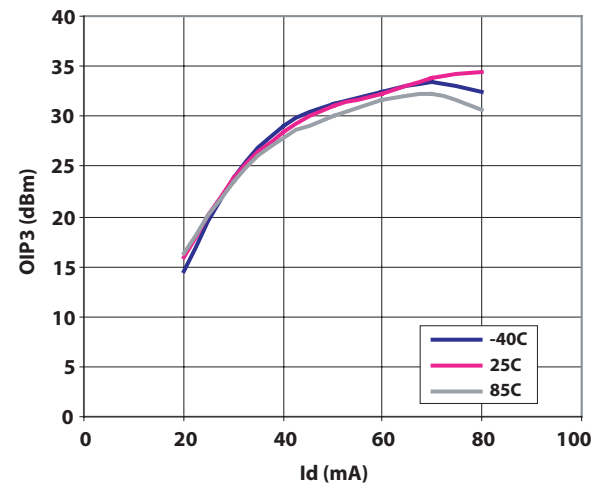

Figure 12. OIP3 vs. I_d and Temperature at 900 MHz.

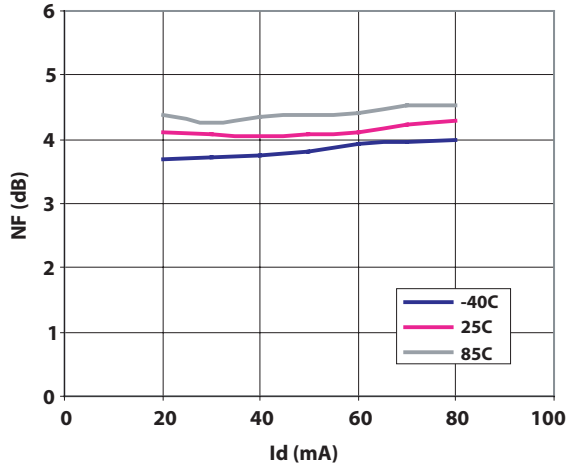

Figure 13. NF vs. Id and Temperature at 900 MHz.

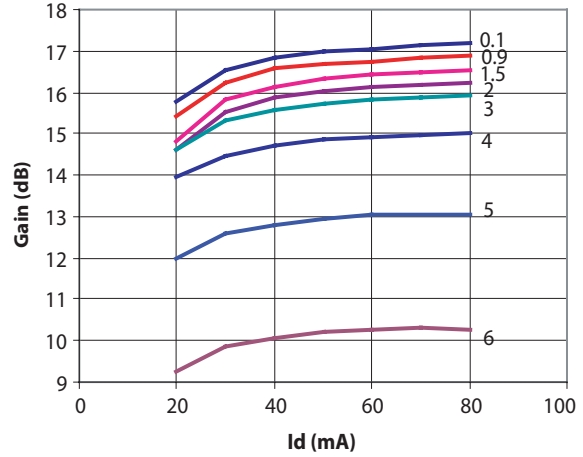

Figure 14. Gain vs Id and Frequency (GHz).

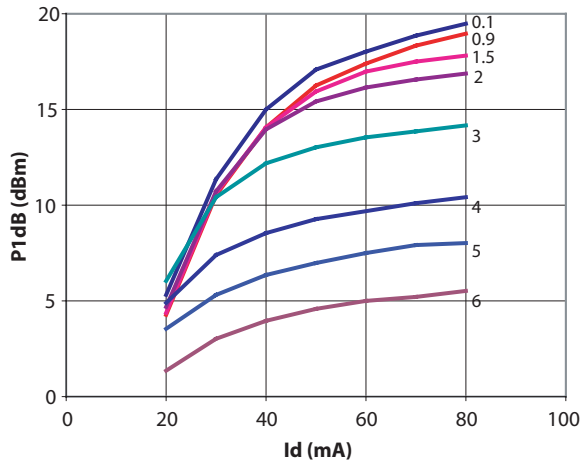

Figure 15. P1dB vs Id and Frequency (GHz).

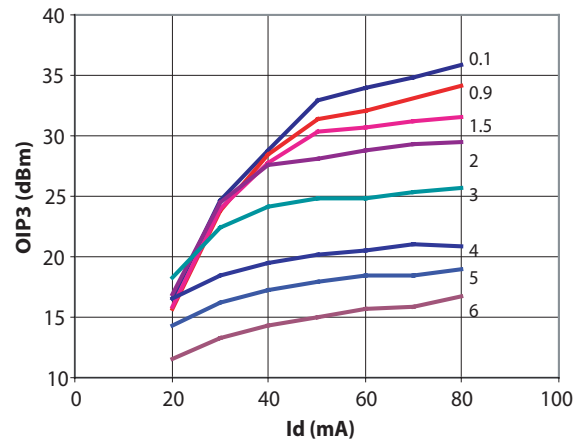

Figure 16. OIP3 vs Id and Frequency (GHz).

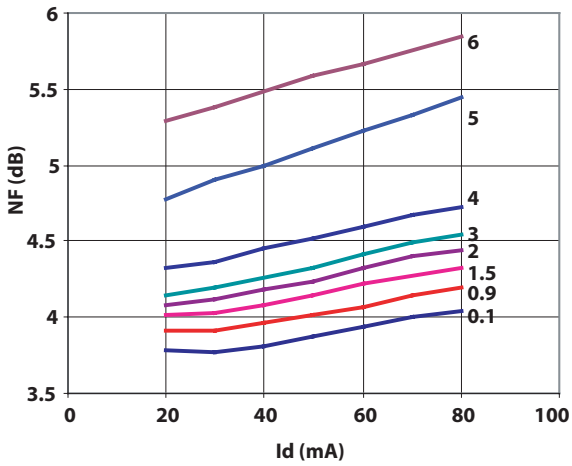

Figure 17. NF vs Id and Frequency (GHz).

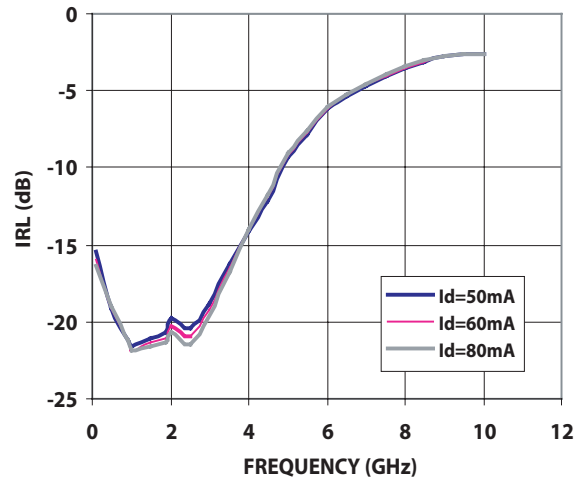

Figure 18. Input Return Loss vs Id and Frequency.

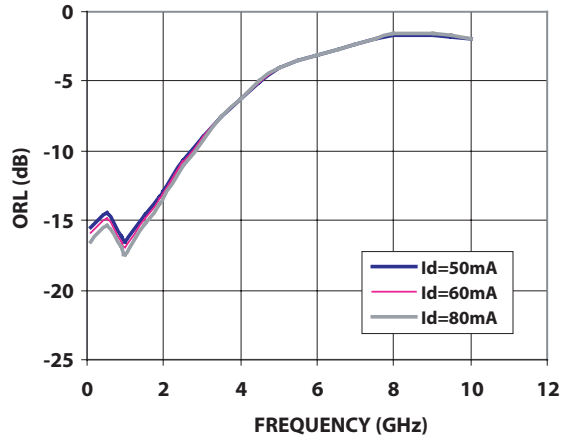

Figure 19. Output Return Loss vs Id and Frequency.

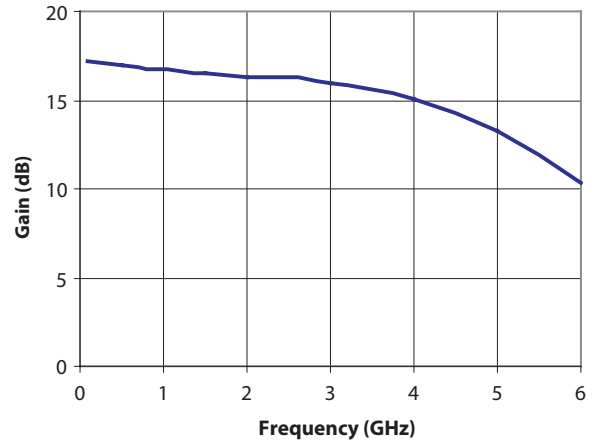

Figure 20. Gain vs Frequency at Id = 80 mA

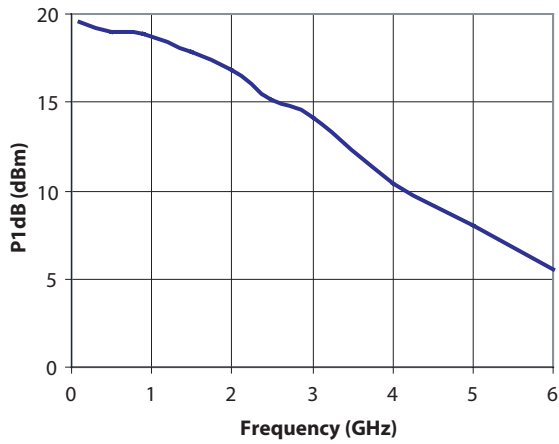

Figure 21. P1dB vs Frequency at Id = 80 mA

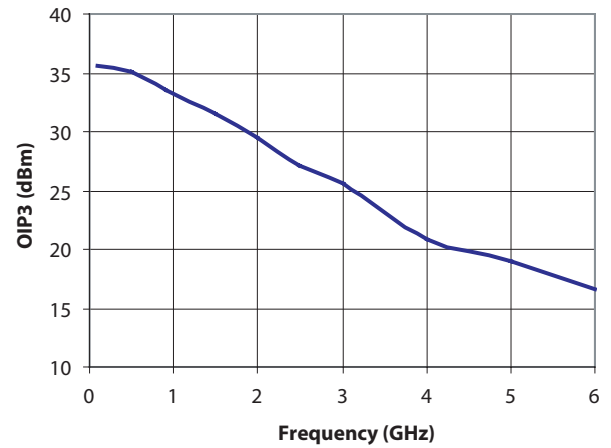

Figure 22. OIP3 vs Frequency at Id = 80 mA

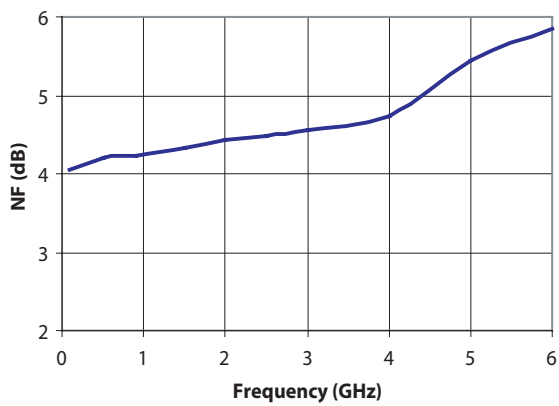

Figure 23. NF vs Frequency at Id = 80 mA

Typical Scattering Parameters At 25°C, Id = 50mA

Freq. GHz	S11		S21			S12		S22	
	Mag.	Ang.	dB	Mag.	Ang.	Mag.	Ang.	Mag.	Ang.
0.1	0.168	3.0	16.469	6.660	171.3	0.099	-0.2	0.168	-8.4
0.5	0.110	-12.5	16.213	6.466	164.0	0.098	-7.0	0.188	-28.0
0.9	0.087	-50.0	16.182	6.443	144.7	0.094	-14.4	0.157	-72.9
1.0	0.083	-60.1	16.172	6.436	140.0	0.092	-19.2	0.149	-84.4
1.9	0.093	-155.0	15.741	6.124	107.1	0.085	-26.3	0.218	-110.7
2.0	0.103	-144.8	15.695	6.092	103.4	0.084	-27.1	0.226	-114.1
2.5	0.095	176.1	15.528	5.976	84.8	0.084	-31.3	0.292	-146.6
3.0	0.114	144.7	15.362	5.863	66.0	0.085	-35.4	0.358	181.0
3.5	0.154	123.7	15.199	5.754	47.4	0.087	-39.4	0.422	149.3
4.0	0.196	106.1	15.035	5.646	28.7	0.088	-43.6	0.486	115.4
4.5	0.246	98.3	14.357	5.222	9.2	0.086	-49.3	0.559	100.4
5.0	0.344	85.8	13.120	4.529	-11.0	0.084	-56.4	0.629	87.6
5.5	0.405	74.7	11.925	3.947	-31.4	0.083	-64.8	0.669	73.2
6.0	0.489	61.4	10.243	3.252	-50.4	0.080	-72.9	0.700	59.1
6.5	0.540	52.2	9.030	2.828	-67.1	0.076	-79.7	0.732	47.9
7.0	0.582	44.3	7.854	2.470	-82.5	0.071	-86.8	0.764	37.3
7.5	0.625	36.5	6.477	2.108	-97.9	0.067	-93.6	0.794	26.6
8.0	0.667	28.5	4.851	1.748	-113.2	0.061	-100.6	0.827	16.0
8.5	0.696	23.7	3.027	1.417	-122.2	0.055	-104.6	0.827	12.5
9.0	0.728	18.8	0.725	1.087	228.9	0.049	251.6	0.826	9.2
9.5	0.737	13.2	-0.715	0.921	221.1	0.046	245.4	0.816	6.2
10.0	0.738	9.9	-1.809	0.812	-148.1	0.045	238.0	0.797	1.8

Notes:

S parameters are measured on a micro-strip line made on 0.025 inch thick alumina carrier. The input reference plane is at the end of the RFin lead. The output reference plane is at the end of the RFout lead.

Typical Scattering Parameters At 25°C, Id = 60mA

Freq. GHz	S11		S21			S12		S22	
	Mag.	Ang.	dB	Mag.	Ang.	Mag.	Ang.	Mag.	Ang.
0.1	0.160	3.1	16.586	6.750	171.3	0.099	-0.2	0.160	-8.5
0.5	0.110	-6.1	16.325	6.550	164.1	0.098	-6.9	0.180	-30.7
0.9	0.087	-44.2	16.292	6.525	144.8	0.093	-14.2	0.150	-75.4
1.0	0.081	-54.5	16.284	6.519	140.0	0.092	-19.1	0.143	-86.6
1.9	0.089	-151.3	15.855	6.205	107.1	0.084	-26.3	0.212	-112.3
2.0	0.097	-142.1	15.806	6.170	103.4	0.083	-27.1	0.220	-115.2
2.5	0.090	178.3	15.639	6.053	84.7	0.084	-31.2	0.287	-147.7
3.0	0.109	146.7	15.471	5.937	66.0	0.085	-35.3	0.353	179.8
3.5	0.149	126.8	15.298	5.820	47.4	0.086	-39.3	0.420	147.3
4.0	0.198	110.5	15.122	5.703	28.7	0.087	-43.4	0.487	114.7
4.5	0.253	97.5	14.441	5.273	9.3	0.085	-49.1	0.560	100.2
5.0	0.350	85.3	13.217	4.580	-10.9	0.083	-56.2	0.630	87.5
5.5	0.410	74.5	12.019	3.990	-31.3	0.082	-64.6	0.670	73.2
6.0	0.493	61.0	10.344	3.290	-50.2	0.080	-72.3	0.703	59.2
6.5	0.544	52.0	9.124	2.859	-66.9	0.075	-79.3	0.735	47.9
7.0	0.586	44.1	7.945	2.496	-82.3	0.070	-86.2	0.767	37.3
7.5	0.628	36.2	6.580	2.133	-97.6	0.066	-93.1	0.798	26.6
8.0	0.670	28.3	4.959	1.770	-113.0	0.061	-100.0	0.830	16.0
8.5	0.700	23.5	3.317	1.435	-122.0	0.055	-104.0	0.830	12.6
9.0	0.730	18.6	0.828	1.100	229.1	0.049	252.0	0.830	9.2
9.5	0.740	13.1	-0.630	0.930	221.4	0.046	246.0	0.820	6.2
10.0	0.740	9.7	-1.724	0.820	-147.8	0.045	238.6	0.800	1.7

Notes:

S parameters are measured on a micro-strip line made on 0.025 inch thick alumina carrier. The input reference plane is at the end of the RFin lead. The output reference plane is at the end of the RFout lead.

Typical Scattering Parameters At 25°C, Id = 80mA

Freq. GHz	S11		S21			S12		S22	
	Mag.	Ang.	dB	Mag.	Ang.	Mag.	Ang.	Mag.	Ang.
0.1	0.151	3.1	16.716	6.852	171.3	0.098	-0.2	0.150	-8.5
0.5	0.112	1.1	16.45	6.645	164.1	0.097	-6.8	0.171	-34.4
0.9	0.087	-37.7	16.416	6.619	144.7	0.092	-14.2	0.142	-78.4
1.0	0.081	-48.0	16.408	6.613	140.0	0.091	-18.9	0.135	-89.3
1.9	0.086	-147.0	15.980	6.295	107.0	0.084	-26.1	0.204	-114.1
2.0	0.093	-138.8	15.931	6.260	103.3	0.083	-27.0	0.212	-116.3
2.5	0.085	181.0	15.768	6.143	84.6	0.083	-31.0	0.279	-148.7
3.0	0.104	148.5	15.596	6.023	65.8	0.084	-35.1	0.347	178.6
3.5	0.145	129.5	15.414	5.898	47.2	0.085	-39.2	0.417	144.7
4.0	0.199	114.6	15.227	5.772	28.5	0.086	-43.2	0.487	113.6
4.5	0.259	98.5	14.543	5.335	9.0	0.084	-48.8	0.562	99.6
5.0	0.356	85.3	13.319	4.634	-11.2	0.083	-55.9	0.630	87.1
5.5	0.417	74.4	12.108	4.031	-31.6	0.081	-64.1	0.670	73.0
6.0	0.500	60.9	10.428	3.322	-50.6	0.079	-72.1	0.702	59.0
6.5	0.551	51.8	9.191	2.881	-67.2	0.075	-78.7	0.735	47.8
7.0	0.592	43.9	8.000	2.512	-82.6	0.070	-85.6	0.767	37.1
7.5	0.634	36.0	6.629	2.145	-97.9	0.066	-92.6	0.798	26.5
8.0	0.674	28.0	4.994	1.777	-113.2	0.060	-99.6	0.830	15.9
8.5	0.705	23.3	3.161	1.439	-122.1	0.054	-103.5	0.830	12.5
9.0	0.733	18.4	0.844	1.102	229.0	0.049	252.9	0.830	9.1
9.5	0.743	12.9	-0.602	0.933	221.4	0.046	-113.4	0.820	6.2
10.0	0.744	9.6	-1.713	0.821	-147.7	0.045	239.1	0.800	1.6

Notes:

S parameters are measured on a micro-strip line made on 0.025 inch thick alumina carrier. The input reference plane is at the end of the RFin lead. The output reference plane is at the end of the RFout lead.

Part Number Ordering Information

Part Number	No of Devices	Container
ADA-4789-TR1G	3000	13" Reel
ADA-4789-BLKG	100	Anti-Static Bag

SOT 89 Package Dimensions

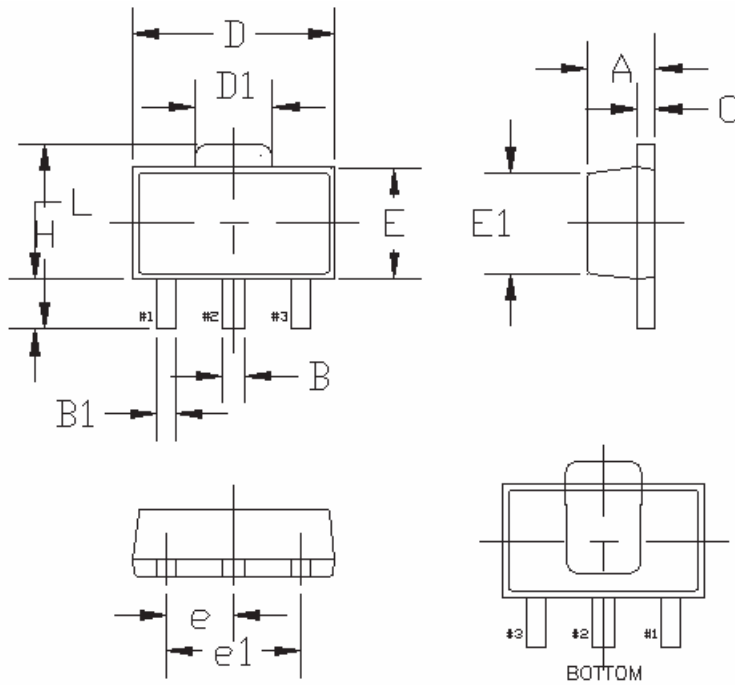

SYMBOL	COMMON					
	DIMENSIONS MILLIMETER			DIMENSIONS INCH		
	MIN.	NOM.	MAX.	MIN.	NOM.	MAX.
A	1.40	1.50	1.60	0.055	0.059	0.063
B	0.44	0.50	0.56	0.017	0.0195	0.022
B1	0.36	0.42	0.48	0.014	0.0165	0.019
C	0.35	0.40	0.44	0.014	0.016	0.017
D	4.40	4.50	4.60	0.173	0.177	0.181
D1	1.62	1.73	1.83	0.064	0.068	0.072
E	2.30	2.50	2.60	0.090	0.096	0.102
E1	2.13	2.20	2.29	0.084	0.087	0.090
e	1.50 BSC			0.059 BSC		
e1	3.00 BSC			0.118 BSC		
H	3.95	4.10	4.25	0.155	0.161	0.167
L	0.90	1.10	1.20	0.035	0.038	0.047

Notes:

1. Dimensioning and tolerancing per ANSI Y14.5M-1982
2. Controlling dimension: Millimeter convert to Inch are not necessary exact.
3. Dimension B1, 2 places.

Device Orientation

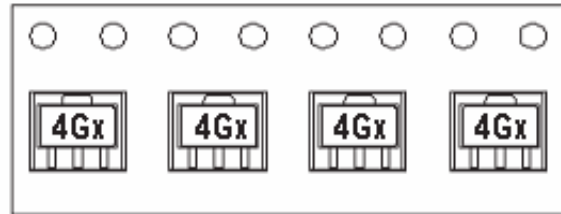
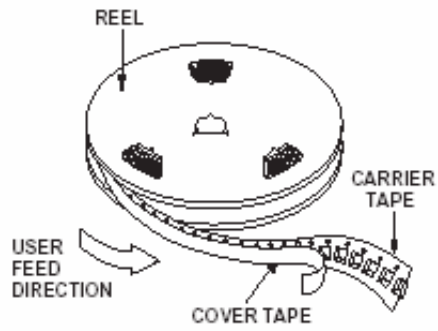

Tape Dimensions

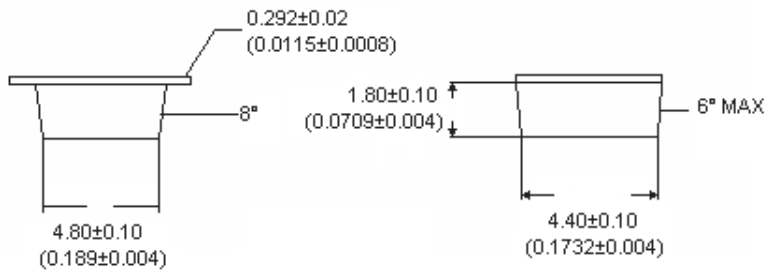
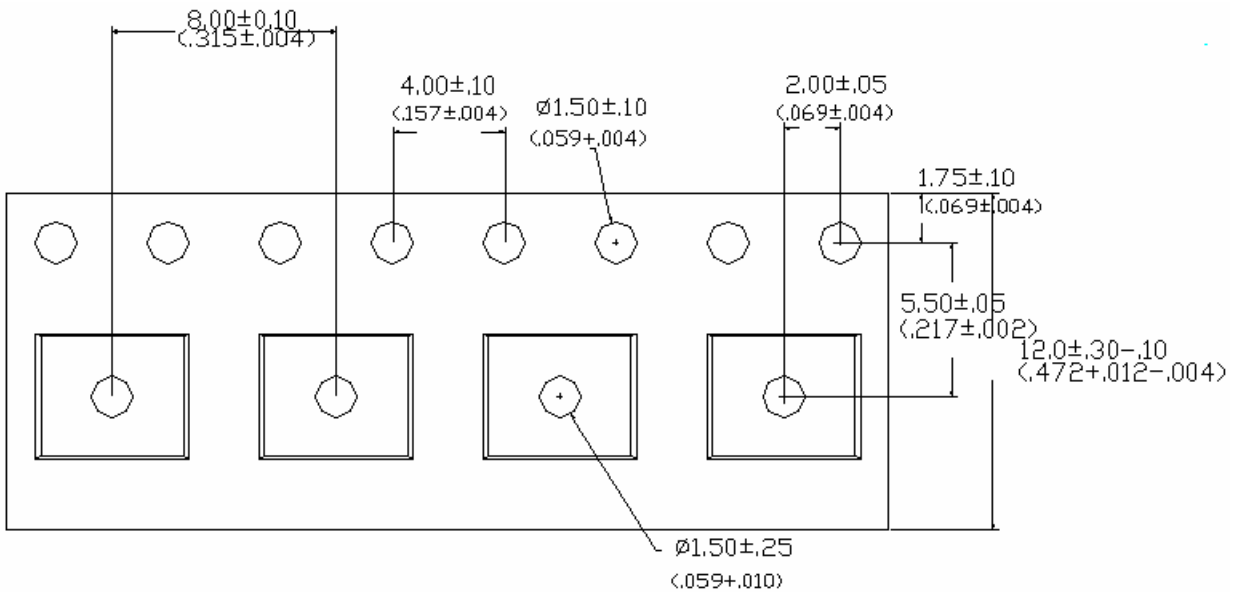

For product information and a complete list of distributors, please go to our web site: www.avagotech.com

Avago, Avago Technologies, and the A logo are trademarks of Avago Technologies, Limited in the United States and other countries. Data subject to change. Copyright © 2007 Avago Technologies Limited. All rights reserved. Obsoletes AV01-0295EN AV02-0052EN - January 12, 2007

AVAGO
TECHNOLOGIES