

$V_{DSS}$	-12V
$R_{DS(on)}(Max.)$	43m $\Omega$
$I_D$	$\pm 3.5A$
$P_D$	1.25W

●Features

- 1) Low on - resistance.
- 2) -1.5V Drive.
- 3) Built-in G-S Protection Diode.
- 4) Small Surface Mount Package (TSST8).
- 5) Pb-free lead plating ; RoHS compliant

●Application

Switching

●Outline

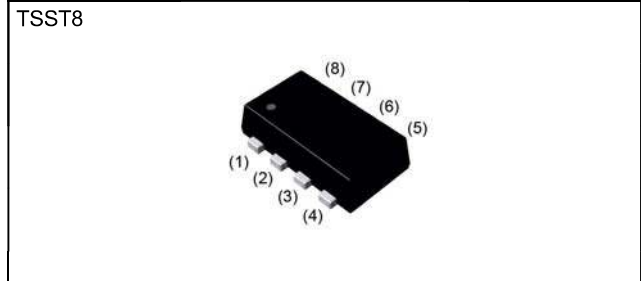

●Inner circuit

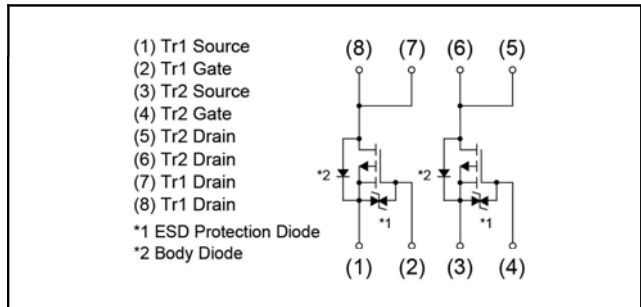

●Packaging specifications

Type	Packing	Embossed Tape
	Reel size (mm)	180
	Tape width (mm)	8
	Basic ordering unit (pcs)	3000
	Taping code	TR
	Marking	J11

●Absolute maximum ratings ( $T_a = 25^\circ C$ ) <It is the same ratings for the Tr1 and Tr2>

Parameter		Symbol	Value	Unit
Drain - Source voltage		$V_{DSS}$	-12	V
Continuous drain current		$I_D$	$\pm 3.5$	A
Pulsed drain current		$I_{D,pulse}^{*1}$	$\pm 12$	A
Gate - Source voltage		$V_{GSS}$	0~-8	V
Power dissipation	total	$P_D^{*2}$	1.25	W
	element		1	
	total	$P_D^{*3}$	0.6	
Junction temperature		$T_j$	150	$^\circ C$
Range of storage temperature		$T_{stg}$	-55 to +150	$^\circ C$

### ● Thermal resistance

Parameter		Symbol	Values			Unit
			Min.	Typ.	Max.	
Thermal resistance, junction - ambient	total	$R_{thJA}^{*2}$	-	-	100	°C/W
	element		-	-	125	
	total	$R_{thJA}^{*3}$	-	-	208	

### ● Electrical characteristics ( $T_a = 25^\circ\text{C}$ ) <It is the same characteristics for the Tr1 and Tr2>

Parameter	Symbol	Conditions	Values			Unit
			Min.	Typ.	Max.	
Drain - Source breakdown voltage	$V_{(BR)DSS}$	$V_{GS} = 0V, I_D = -1mA$	-12	-	-	V
Breakdown voltage temperature coefficient	$\frac{\Delta V_{(BR)DSS}}{\Delta T_j}$	$I_D = -1mA$ referenced to $25^\circ\text{C}$	-	-5.0	-	mV/°C
Zero gate voltage drain current	$I_{DSS}$	$V_{DS} = -12V, V_{GS} = 0V$	-	-	-10	$\mu\text{A}$
Gate - Source leakage current	$I_{GSS}$	$V_{DS} = 0V, V_{GS} = -8V$	-	-	-10	$\mu\text{A}$
Gate threshold voltage	$V_{GS(th)}$	$V_{DS} = -6V, I_D = -1mA$	-0.3	-	-1.0	V
Gate threshold voltage temperature coefficient	$\frac{\Delta V_{GS(th)}}{\Delta T_j}$	$I_D = -1mA$ referenced to $25^\circ\text{C}$	-	2.7	-	mV/°C
Static drain - source on - state resistance	$R_{DS(on)}^{*4}$	$V_{GS} = -4.5V, I_D = -3.5A$	-	31	43	m $\Omega$
		$V_{GS} = -2.5V, I_D = -1.7A$	-	43	60	
		$V_{GS} = -1.8V, I_D = -1.7A$	-	60	90	
		$V_{GS} = -1.5V, I_D = -0.7A$	-	80	160	
Gate input resistance	$R_G$	f = 1MHz, open drain	-	10	-	$\Omega$
Forward Transfer Admittance	$ Y_{fs} ^{*4}$	$V_{DS} = -6V, I_D = -3.5A$	4	-	-	S

● **Electrical characteristics** ( $T_a = 25^\circ\text{C}$ ) <It is the same characteristics for the Tr1 and Tr2>

Parameter	Symbol	Conditions	Values			Unit
			Min.	Typ.	Max.	
Input capacitance	$C_{iss}$	$V_{GS} = 0V$	-	2600	-	pF
Output capacitance	$C_{oss}$	$V_{DS} = -6V$	-	200	-	
Reverse transfer capacitance	$C_{rss}$	$f = 1\text{MHz}$	-	190	-	
Turn - on delay time	$t_{d(on)}^{*4}$	$V_{DD} \approx -6V, V_{GS} = -4.5V$	-	15	-	ns
Rise time	$t_r^{*4}$	$I_D = -1.7A$	-	30	-	
Turn - off delay time	$t_{d(off)}^{*4}$	$R_L = 3.5\Omega$	-	170	-	
Fall time	$t_f^{*4}$	$R_G = 10\Omega$	-	60	-	

● **Gate charge characteristics** ( $T_a = 25^\circ\text{C}$ ) <It is the same characteristics for the Tr1 and Tr2>

Parameter	Symbol	Conditions	Values			Unit
			Min.	Typ.	Max.	
Total gate charge	$Q_g^{*4}$	$V_{DD} \approx -6V$	-	22	-	nC
Gate - Source charge	$Q_{gs}^{*4}$	$I_D = -3.5A$	-	3.9	-	
Gate - Drain charge	$Q_{gd}^{*4}$	$V_{GS} = -4.5V$	-	3.1	-	

● **Body diode electrical characteristics** (Source-Drain) ( $T_a = 25^\circ\text{C}$ )

<It is the same characteristics for the Tr1 and Tr2>

Parameter	Symbol	Conditions	Values			Unit
			Min.	Typ.	Max.	
Body diode continuous forward current	$I_S$	$T_a = 25^\circ\text{C}$	-	-	-0.8	A
Body diode pulse current	$I_{SP}^{*1}$		-	-	-12	
Forward voltage	$V_{SD}^{*4}$	$V_{GS} = 0V, I_S = -3.5A$	-	-	-1.2	V

\*1  $P_w \leq 10\mu\text{s}$ , Duty cycle  $\leq 1\%$

\*2 Mounted on a ceramic board (30×30×0.8mm)

\*3 Mounted on a FR4 (20×20×0.8mm)

\*4 Pulsed

●Electrical characteristic curves

Fig.1 Power Dissipation Derating Curve

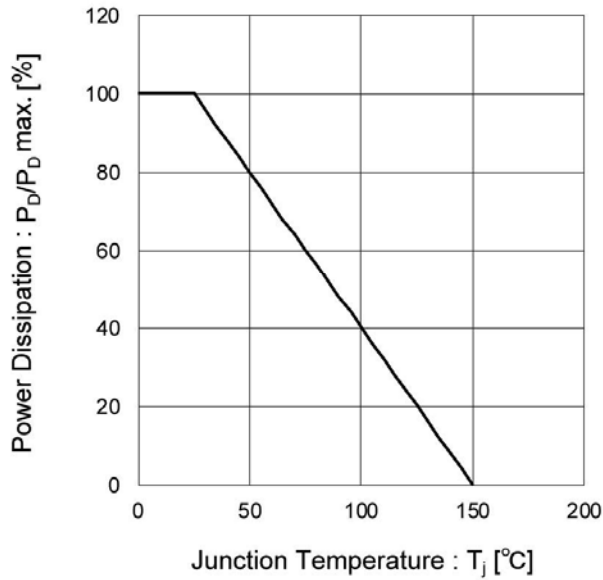

Fig.2 Maximum Safe Operating Area

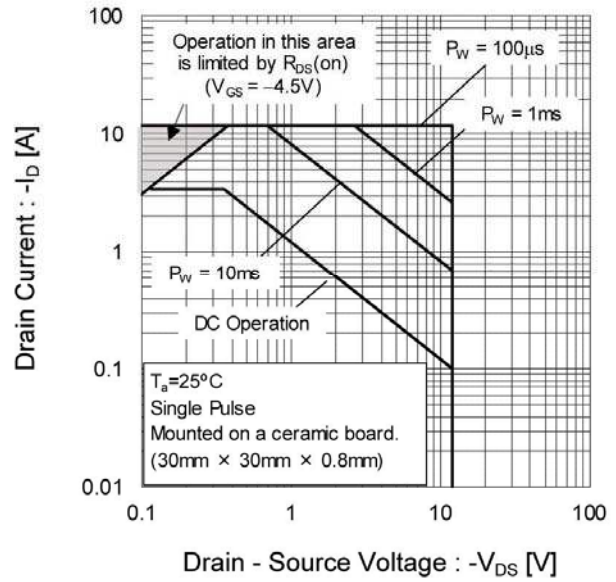

Fig.3 Normalized Transient Thermal Resistance vs. Pulse Width

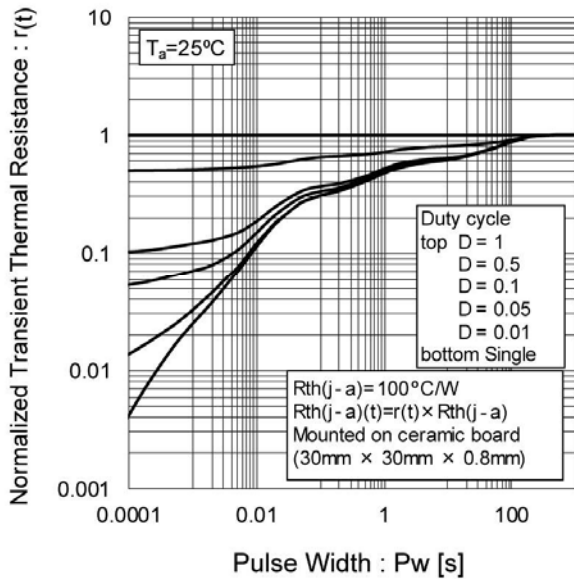
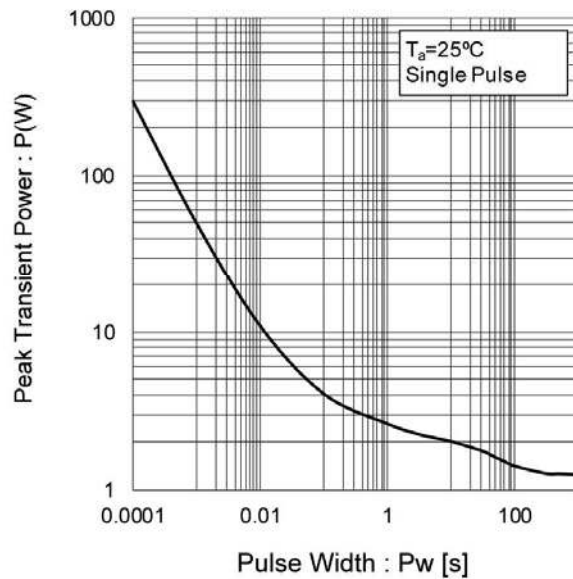

Fig.4 Single Pulse Maximum Power dissipation



●Electrical characteristic curves

Fig.5 Typical Output Characteristics(I)

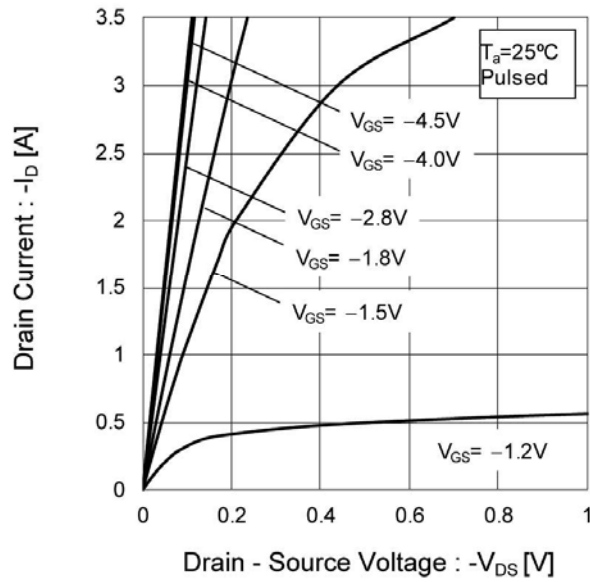

Fig.6 Typical Output Characteristics(II)

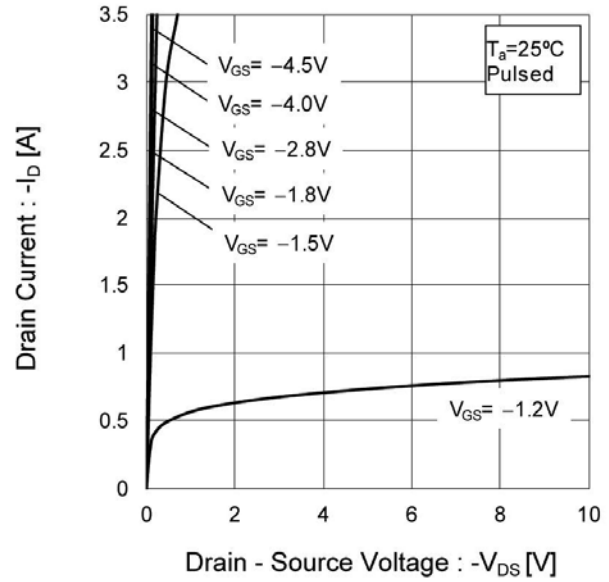

Fig.7 Breakdown Voltage vs. Junction Temperature

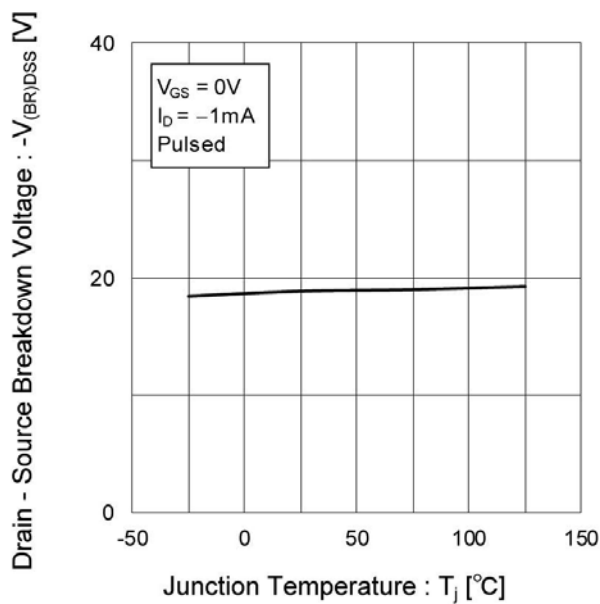
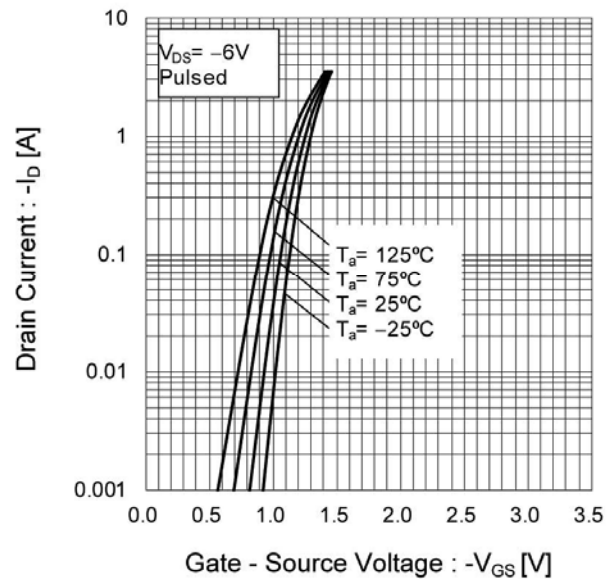

Fig.8 Typical Transfer Characteristics



●Electrical characteristic curves

Fig.9 Gate Threshold Voltage vs. Junction Temperature

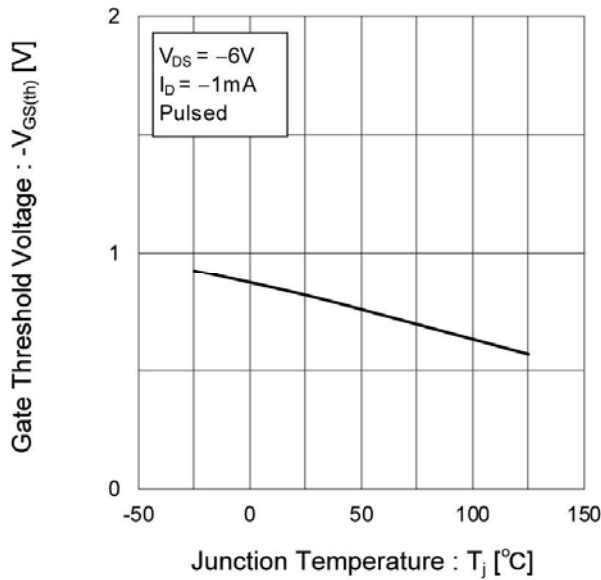

Fig.10 Forward Transfer Admittance vs. Drain Current

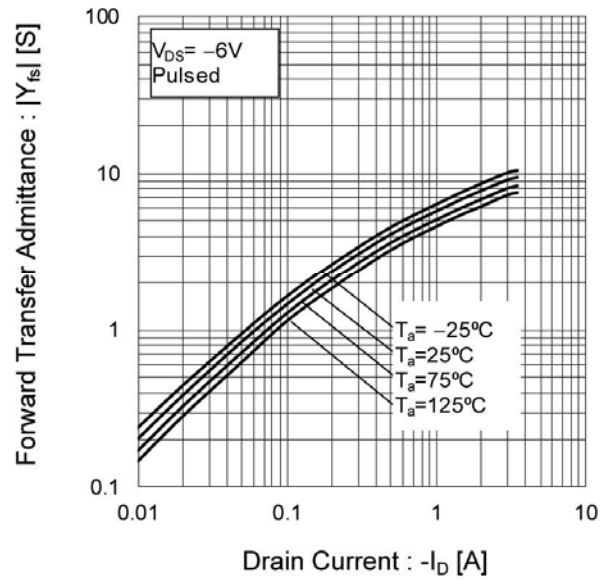

Fig.11 Drain Current Derating Curve

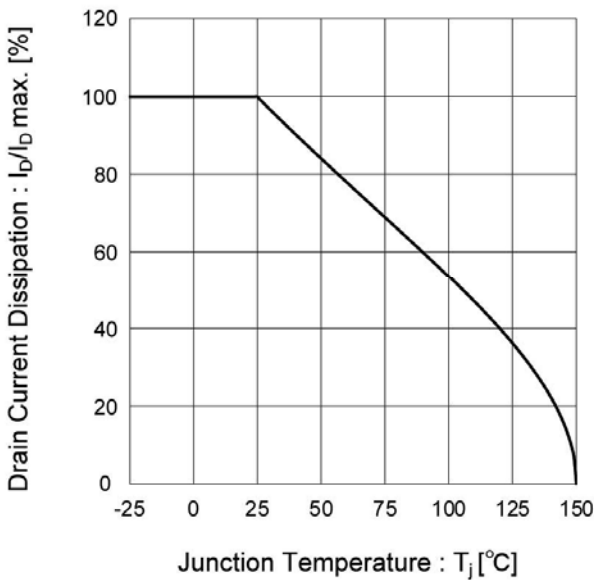
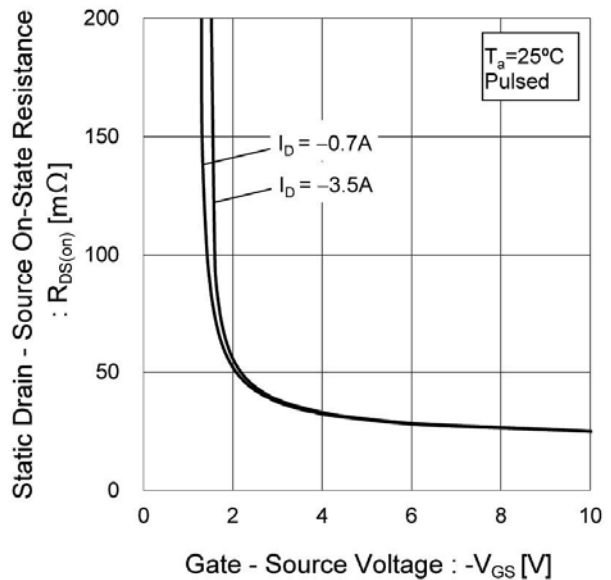

Fig.12 Static Drain - Source On - State Resistance vs. Gate Source Voltage



●Electrical characteristic curves

Fig.13 Static Drain - Source On - State Resistance vs. Junction Temperature

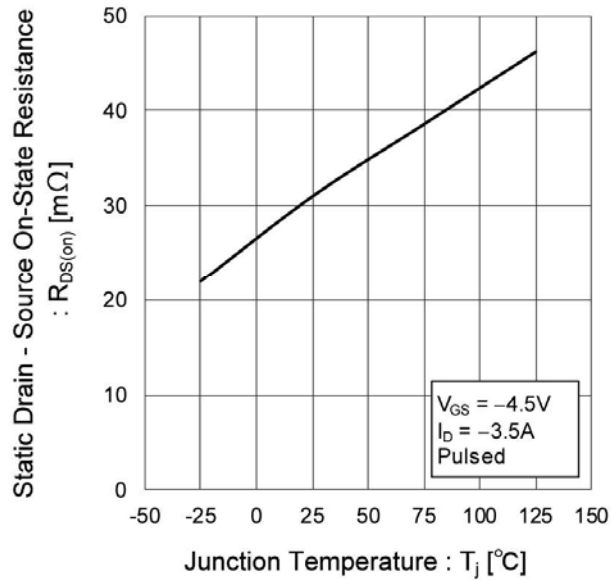
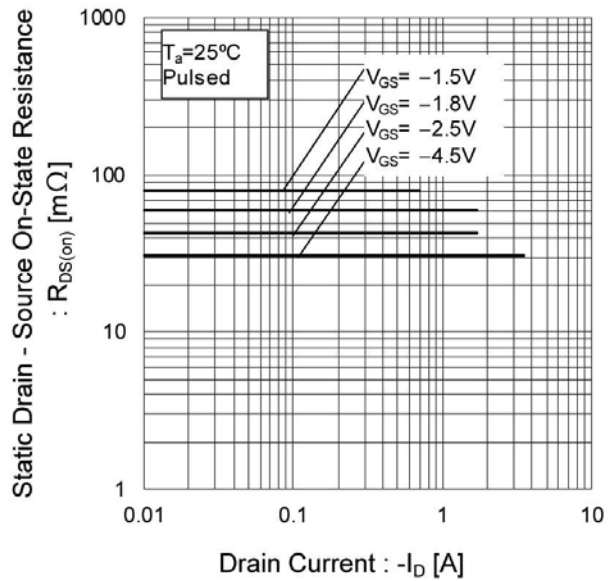

Fig.14 Static Drain - Source On - State Resistance vs. Drain Current(I)



● Electrical characteristic curves

Fig.15 Static Drain - Source On - State Resistance vs. Drain Current(II)

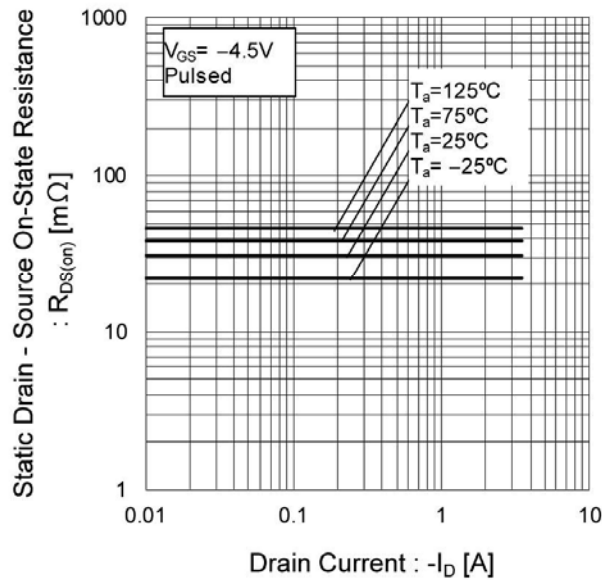

Fig.16 Static Drain - Source On - State Resistance vs. Drain Current(III)

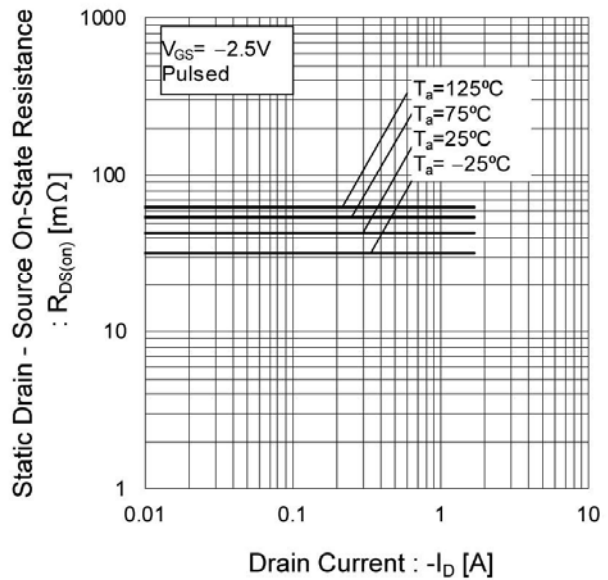

Fig.17 Static Drain - Source On - State Resistance vs. Drain Current(IV)

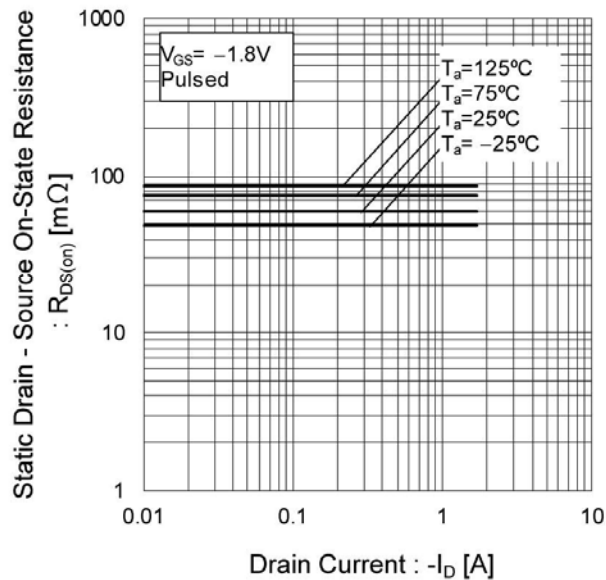
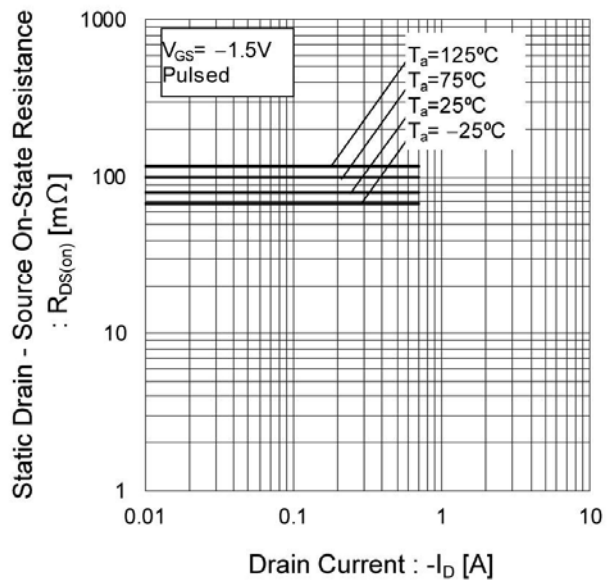

Fig.18 Static Drain - Source On - State Resistance vs. Drain Current(V)





●Electrical characteristic curves

Fig.19 Typical Capacitance vs. Drain - Source Voltage

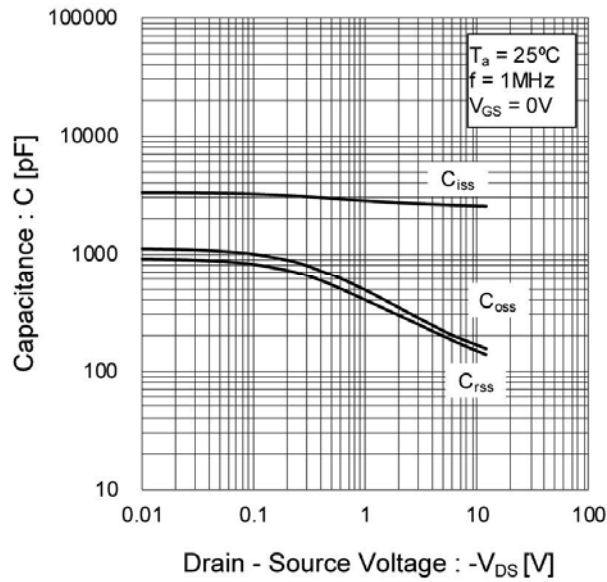

Fig.20 Switching Characteristics

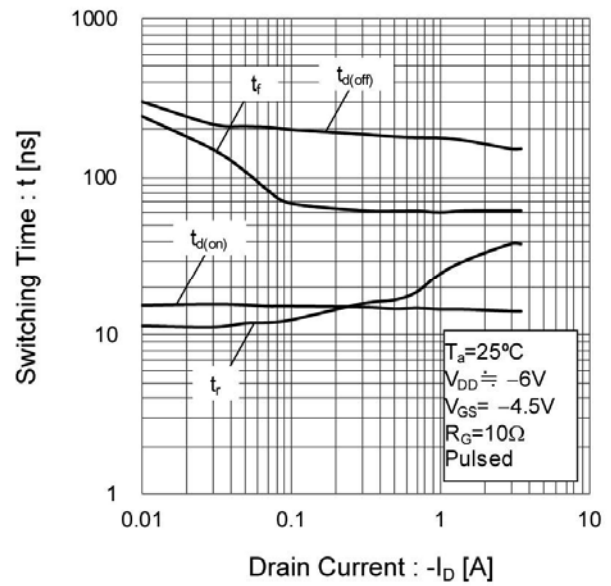

Fig.21 Dynamic Input Characteristics

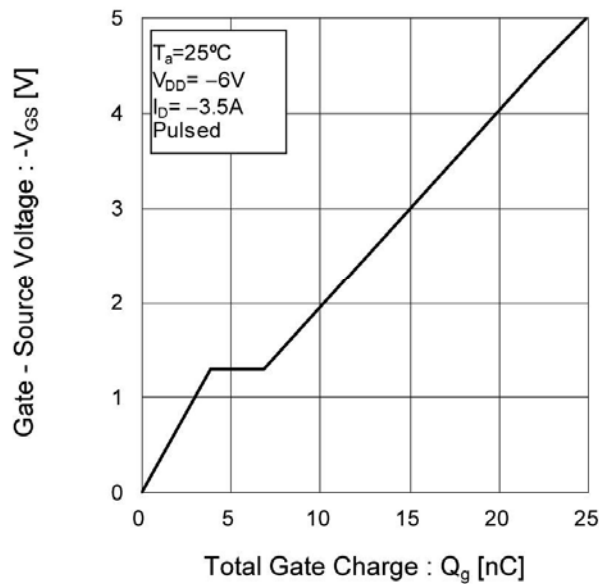
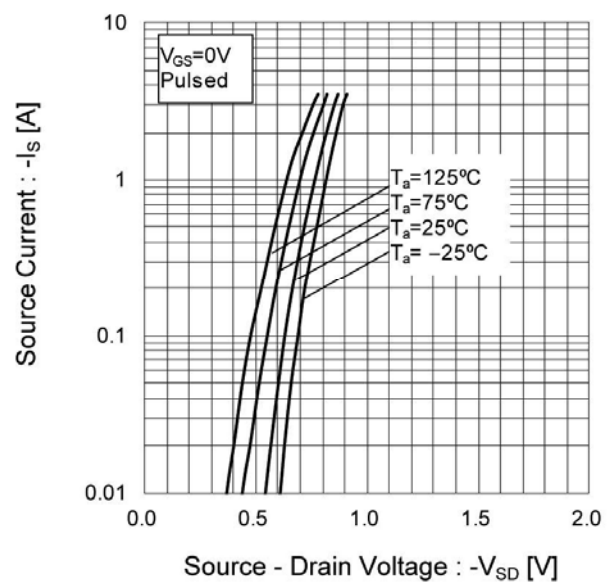

Fig.22 Source Current vs. Source Drain Voltage



● Measurement circuits <It is the same for the Tr1 and Tr2>

Fig. 1-1 SWITCHING TIME MEASUREMENT CIRCUIT

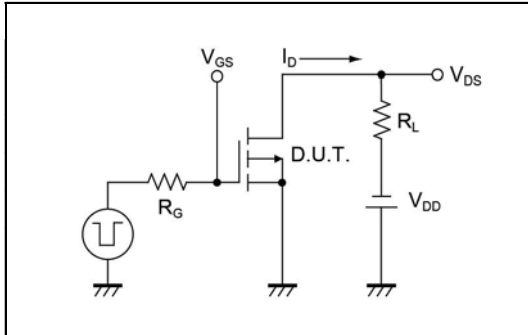

Fig. 1-2 SWITCHING WAVEFORMS

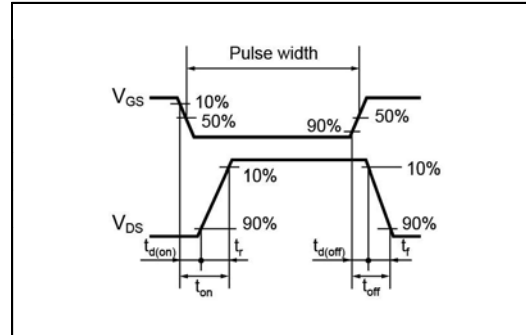

Fig. 2-1 GATE CHARGE MEASUREMENT CIRCUIT

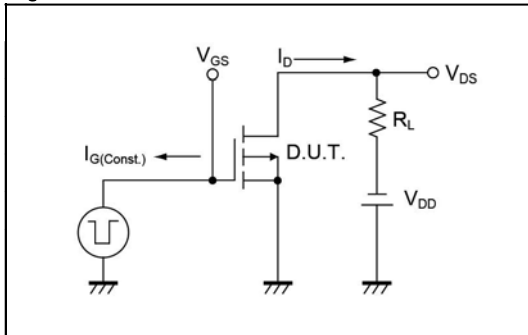
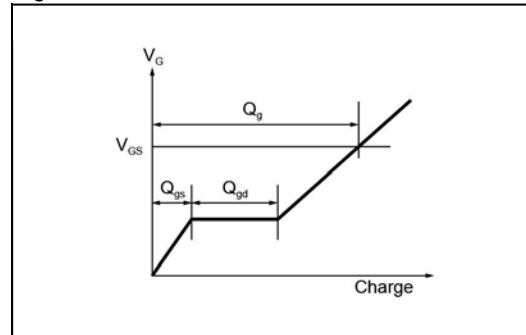

Fig. 2-2 GATE CHARGE WAVEFORM



● Notice

This product might cause chip aging and breakdown under the large electrified environment. Please consider to design ESD protection circuit.

●Dimensions

TSST8

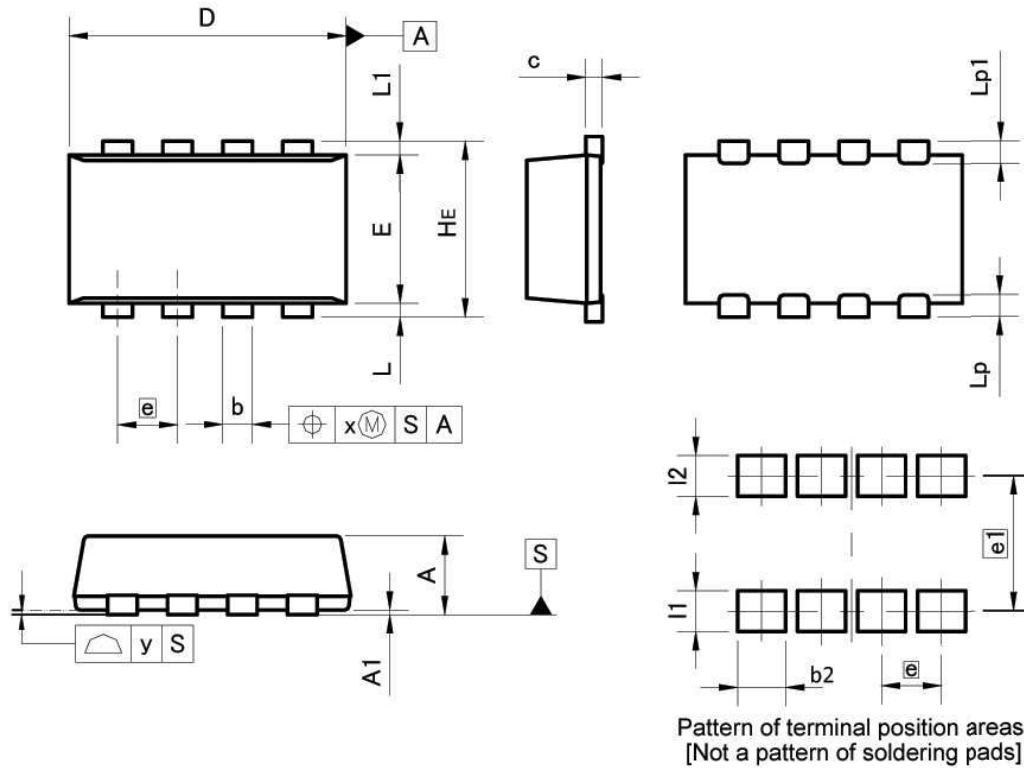

Pattern of terminal position areas  
[Not a pattern of soldering pads]

DIM	MILIMETERS		INCHES	
	MIN	MAX	MIN	MAX
A	0.75	0.85	0.030	0.033
A1	0.00	0.05	0.000	0.002
b	0.22	0.42	0.009	0.017
c	0.12	0.22	0.005	0.009
D	2.90	3.10	0.114	0.122
E	1.50	1.70	0.059	0.067
e	0.65		0.026	
HE	1.80	2.00	0.071	0.079
L	0.05	0.25	0.002	0.010
L1	0.05	0.25	0.002	0.010
Lp	0.15	0.34	0.006	0.013
Lp1	0.15	0.34	0.006	0.013
x	-	0.10	-	0.004
y	-	0.10	-	0.004

DIM	MILIMETERS		INCHES	
	MIN	MAX	MIN	MAX
b2	-	0.52	-	0.020
e1	1.46		0.057	
I1	-	0.44	-	0.017
I2	-	0.44	-	0.017

Dimension in mm/inches

## Notes

- 1) The information contained herein is subject to change without notice.
- 2) Before you use our Products, please contact our sales representative and verify the latest specifications :
- 3) Although ROHM is continuously working to improve product reliability and quality, semiconductors can break down and malfunction due to various factors. Therefore, in order to prevent personal injury or fire arising from failure, please take safety measures such as complying with the derating characteristics, implementing redundant and fire prevention designs, and utilizing backups and fail-safe procedures. ROHM shall have no responsibility for any damages arising out of the use of our Products beyond the rating specified by ROHM.
- 4) Examples of application circuits, circuit constants and any other information contained herein are provided only to illustrate the standard usage and operations of the Products. The peripheral conditions must be taken into account when designing circuits for mass production.
- 5) The technical information specified herein is intended only to show the typical functions of and examples of application circuits for the Products. ROHM does not grant you, explicitly or implicitly, any license to use or exercise intellectual property or other rights held by ROHM or any other parties. ROHM shall have no responsibility whatsoever for any dispute arising out of the use of such technical information.
- 6) The Products are intended for use in general electronic equipment (i.e. AV/OA devices, communication, consumer systems, gaming/entertainment sets) as well as the applications indicated in this document.
- 7) The Products specified in this document are not designed to be radiation tolerant.
- 8) For use of our Products in applications requiring a high degree of reliability (as exemplified below), please contact and consult with a ROHM representative : transportation equipment (i.e. cars, ships, trains), primary communication equipment, traffic lights, fire/crime prevention, safety equipment, medical systems, servers, solar cells, and power transmission systems.
- 9) Do not use our Products in applications requiring extremely high reliability, such as aerospace equipment, nuclear power control systems, and submarine repeaters.
- 10) ROHM shall have no responsibility for any damages or injury arising from non-compliance with the recommended usage conditions and specifications contained herein.
- 11) ROHM has used reasonable care to ensure the accuracy of the information contained in this document. However, ROHM does not warrant that such information is error-free, and ROHM shall have no responsibility for any damages arising from any inaccuracy or misprint of such information.
- 12) Please use the Products in accordance with any applicable environmental laws and regulations, such as the RoHS Directive. For more details, including RoHS compatibility, please contact a ROHM sales office. ROHM shall have no responsibility for any damages or losses resulting from non-compliance with any applicable laws or regulations.
- 13) When providing our Products and technologies contained in this document to other countries, you must abide by the procedures and provisions stipulated in all applicable export laws and regulations, including without limitation the US Export Administration Regulations and the Foreign Exchange and Foreign Trade Act.
- 14) This document, in part or in whole, may not be reprinted or reproduced without prior consent of ROHM.



Thank you for your accessing to ROHM product informations.  
More detail product informations and catalogs are available, please contact us.

**ROHM Customer Support System**

<http://www.rohm.com/contact/>