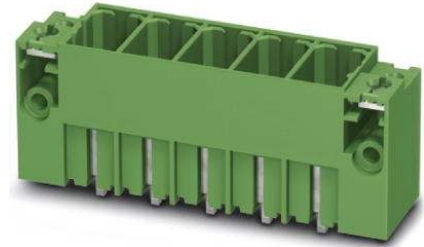

PCV 35 HC/ 2-GF-15,00

Order No.: 1762796

<http://eshop.phoenixcontact.de/phoenix/treeViewClick.do?UID=1762796>

Header, Nominal current: 125 A, Nom. voltage: 1000 V, Pitch: 15 mm,
Number of positions: 2, Color: green, Assembly: Soldering

Commercial data

EAN	4046356444057
Pack	25 pcs.
Customs tariff	85366990
Weight/Piece	0.04831 KG
Catalog page information	Page 443 (CC-2009)

[http://
www.download.phoenixcontact.com](http://www.download.phoenixcontact.com)
Please note that the data given
here has been taken from the
online catalog. For comprehensive
information and data, please refer
to the user documentation. The
General Terms and Conditions of
Use apply to Internet downloads.

Technical data

Dimensions / positions

Pitch	15 mm
Dimension a	15 mm
Number of positions	2
Pin spacing	15 mm

Technical data

Insulating material group	IIIa
Rated surge voltage (III/3)	8 kV
Rated surge voltage (III/2)	8 kV
Rated surge voltage (II/2)	8 kV

Rated voltage (III/2)	1000 V
Rated voltage (II/2)	1000 V
Nominal current I_N	125 A
Nominal voltage U_N	1000 V
Maximum load current	125 A
Insulating material	PBT
Inflammability class acc. to UL 94	V0

Diagrams/Drawings

Drilling plan/solder pad geometry

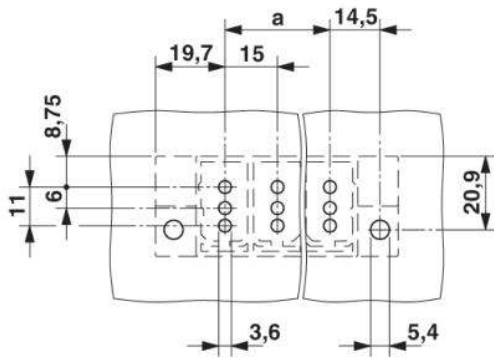

Dimensioned drawing

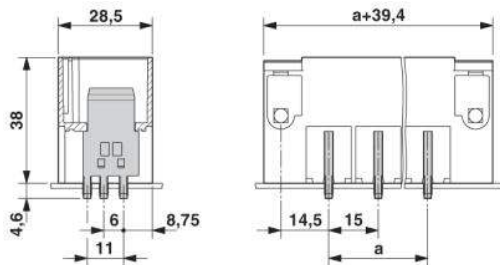

Address

PHOENIX CONTACT Inc., USA
586 Fulling Mill Road
Middletown, PA 17057, USA
Phone (800) 888-7388
Fax (717) 944-1625
<http://www.phoenixcon.com>



© 2010 Phoenix Contact
Technical modifications reserved;