



# Specific Lighting Product Data Sheet

## LTW-008RGB2-PH1

Spec No.: DS23-2014-0033

Effective Date: 01/08/2016

Revision: B

**LITE-ON DCC**

**RELEASE**

BNS-OD-FC001/A4

## Specific Lighting LTW-008RGB2-PH1

### 1. Description

The LTW (LiteOn White LED) is a revolutionary, energy efficient and ultra compact new light source, combining the lifetime and reliability advantages of Light Emitting Diodes with the brightness of conventional lighting. It gives you total design freedom and unmatched brightness, creating a new opportunities for solid state lighting to displace conventional lighting technologies...

#### 1.1 Features

- Package in 16mm tape on 10" diameter reels
- Compatible with automatic placement equipment.
- Compatible with infrared and vapor phase reflow solder process.
- EIA STD package.
- I.C. compatible.
- Meet green product and Pb-free(According to RoHS)

#### 1.2 Benefits Features

- Ambient lights (household appliances)
- Portable (flashlight, bicycle)
- Decorative/Entertainment
- Bollards/Security/Garden
- Traffic signaling/Beacons/ Rail crossing and Wayside
- Indoor/Outdoor Commercial and Residential Architectural
- Edge\_lit signs (Exit, point of sale)

### 2. Outline Dimensions

#### 2.1 Form Factor of 008RGB2

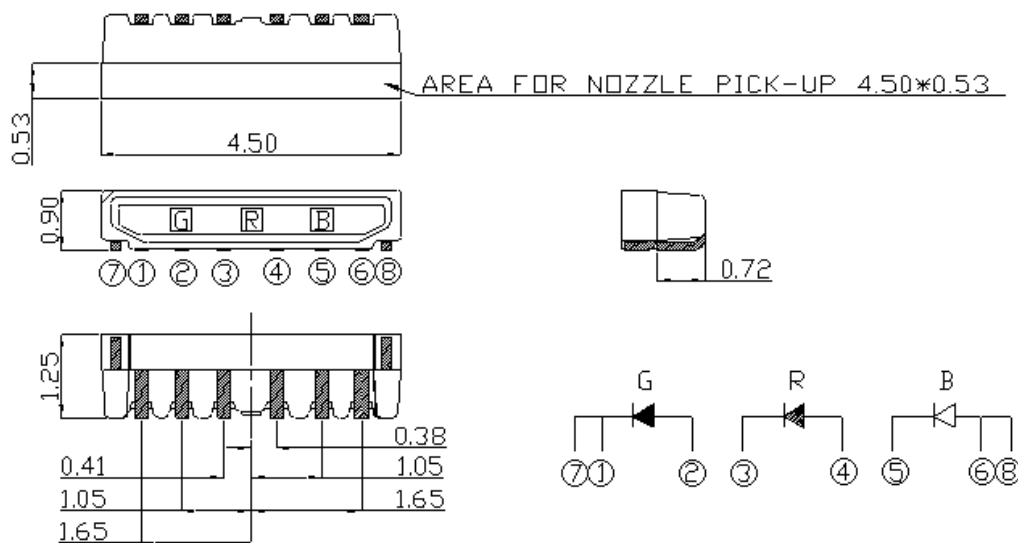

#### 2.2 Coplanarity

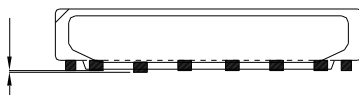

LSL: 0.00 mm (Lead is higher)

USL: 0.08 mm (PPA is higher)

#### Notes

1. All dimensions are in millimeters.
2. Tolerance is  $\pm 0.1$  mm (.004") unless otherwise noted.
3. Coplanarity: The stand-off from PPA to solder surface of leads is limited by USL: 0.08mm; LSL: 0.00mm means the solder surface of leads is higher 0.00mm or lower 0.08mm than PPA in limit.
4. The size of burr which is vertical to solder surface must lower than 0.08mm in limit.

**Specific Lighting  
LTW-008RGB2-PH1**

**3. Absolute Maximum Ratings at Ta=25°C**

Parameter	Symbol	Rating			Unit
		R	G	B	
Power Dissipation	$P_o$	75	120	120	mW
Peak Forward Current <sup>1</sup>	$I_{FP}$	100	100	100	mA
Continuous Forward Current	$I_F$	40	40	40	mA
Reverse Voltage	$V_R$	5			V
Operating Temperature Range	$T_{opr}$	-40 ~ +80			°C
Storage Temperature Range	$T_{stg}$	-40 ~ +100			°C
Soldering Condition <sup>1,2</sup>	$T_{sol}$	260°C For 5 Seconds			

**Notes**

Operating the LED (in an application) under reverse bias condition might result in damage or failure of the component

**4. Suggest IR Reflow Condition**

R-Reflow Soldering Profile for lead free soldering (Acc. to J-STD-020D)

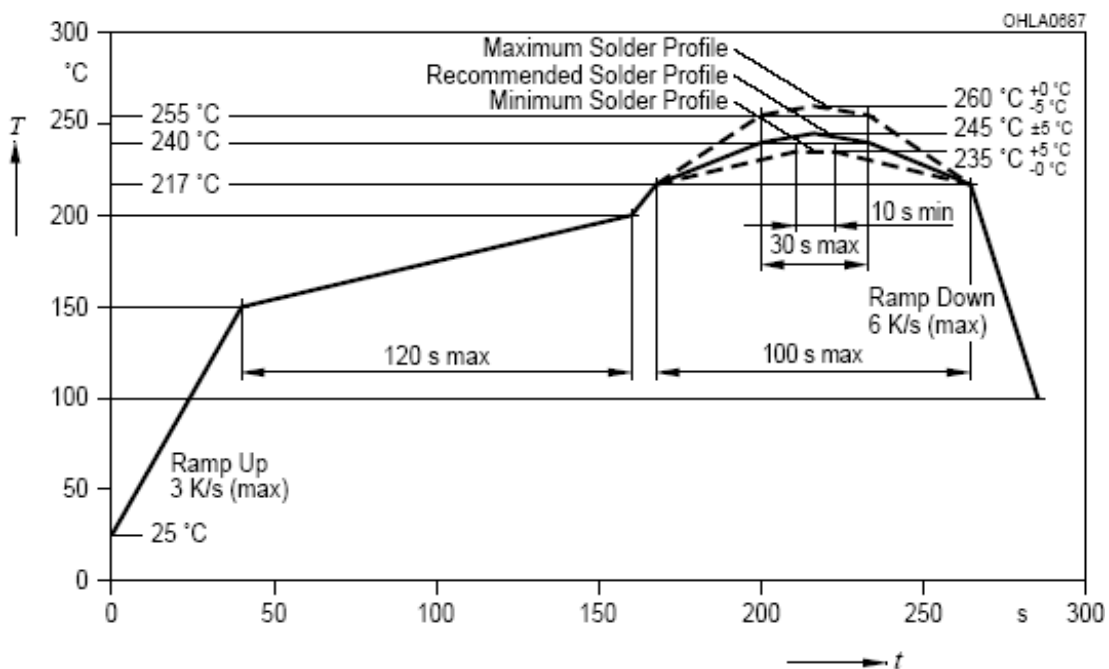

## Specific Lighting LTW-008RGB2-PH1

### 5. Electro-Optical Characteristics at Ta=25°C

Parameter	Symbol	Values				Test Condition	Unit
			R	G	B		
Luminous Flux <sup>1</sup>	$\Phi_v$	Min	2.12	4.88	0.46	R: $I_f = 25\text{mA}$ G: $I_f = 30\text{mA}$ B: $I_f = 15\text{mA}$	lm
		Typ.	2.90	6.10	0.57		
		Max.	-	-	-		
Viewing Angle	$2\theta_{1/2}$	Typ.	130			R: $I_f = 25\text{mA}$ G: $I_f = 30\text{mA}$ B: $I_f = 15\text{mA}$	°
Dominant Wavelength <sup>2</sup>	$\lambda_d$	Min	618	517	455	R: $I_f = 25\text{mA}$ G: $I_f = 30\text{mA}$ B: $I_f = 15\text{mA}$	nm
		Typ.					
		Max.	630	532	465		
Color Coordinate	$\lambda_d(\text{Min})$	Typ. x	0.6879	0.1317~ 0.2150	0.1555	R: $I_f = 25\text{mA}$ G: $I_f = 30\text{mA}$ B: $I_f = 15\text{mA}$	
		Typ. y	0.3115	0.6890	0.0283		
	$\lambda_d(\text{Max})$	Typ. x	0.7055	0.0805~ 0.1825	0.1443		
		Typ. y	0.2940	0.7850	0.0461		
Peak Wavelength	$\lambda_p$	Min				R: $I_f = 25\text{mA}$ G: $I_f = 30\text{mA}$ B: $I_f = 15\text{mA}$	nm
		Typ.	628	523	458		
		Max.					
Forward Voltage <sup>3</sup>	$V_F$	Min	1.8	2.9	2.7	R: $I_f = 25\text{mA}$ G: $I_f = 30\text{mA}$ B: $I_f = 15\text{mA}$	V
		Typ.	2.3	3.4	3.1		
		Max.	2.5	3.8	3.5		
Spectrum Radiation Bandwidth	$\Delta\lambda$	Typ.	20	33	22	R: $I_f = 25\text{mA}$ G: $I_f = 30\text{mA}$ B: $I_f = 15\text{mA}$	nm
Reverse Current	$I_R$	Max.	10			$V_R=5\text{V}$	$\mu\text{A}$

#### Notes

1. Tolerance of Luminous Intensity +/- 10%.
2. Tolerance of Dominant Wavelength +/- 1nm.
3. Tolerance of Forward Voltage +/- 0.1V
4. The chromaticity coordinates (x, y) is derived from the 1931 CIE chromaticity diagram.
5. Caution in ESD: Static Electricity and surge damages the LED. It is recommend to use a wrist band or anti-electrostatic glove when handling the LED. All devices, equipment and machinery must be properly grounded.
6. CAS140B is the test standard for the chromaticity coordinates (x, y) & lm.

## Specific Lighting LTW-008RGB2-PH1

### 6. Bin Code List

#### 6.1 Luminous Flux Spec

Luminous Flux Spec. Table		
IV Bin	Luminous Flux (lm) at $I_f$ : R=25mA, G=30mA, B=15mA	
	Min.	Max.
W0	7.46	8.20
W1	8.20	9.03
W2	9.03	9.93
W3	9.93	10.92
W4	10.92	12.00

Tolerance on each Luminous Intensity bin and Luminous Flux are +/- 10%

#### 6.2 Color Ranks

Color Ranks Table											
Ranks	Color bin limits					Ranks	Color bin limits				
	$I_f$ : R=25mA, G=30mA, B=15mA						$I_f$ : R=25mA, G=30mA, B=15mA				
C1	x	0.2490	0.2550	0.2623	0.2563	F2	x	0.2769	0.2828	0.2901	0.2842
	y	0.2694	0.2561	0.2674	0.2809		y	0.2899	0.2760	0.2871	0.3011
D1	x	0.2563	0.2623	0.2696	0.2636	C3	x	0.2610	0.2670	0.2742	0.2683
	y	0.2809	0.2674	0.2786	0.2923		y	0.2428	0.2295	0.2404	0.2539
E1	x	0.2636	0.2696	0.2769	0.2709	D3	x	0.2683	0.2742	0.2815	0.2755
	y	0.2923	0.2786	0.2899	0.3038		y	0.2539	0.2404	0.2512	0.2649
F1	x	0.2709	0.2769	0.2842	0.2782	E3	x	0.2755	0.2815	0.2887	0.2828
	y	0.3038	0.2899	0.3011	0.3152		y	0.2649	0.2512	0.2621	0.2760
C2	x	0.2550	0.2610	0.2683	0.2623	F3	x	0.2828	0.2887	0.2960	0.2901
	y	0.2561	0.2428	0.2539	0.2674		y	0.2760	0.2621	0.2730	0.2871
D2	x	0.2623	0.2683	0.2755	0.2696	K1	x	0.2782	0.2841	0.2993	0.2934
	y	0.2674	0.2539	0.2649	0.2786		y	0.3152	0.3011	0.3011	0.3152
E2	x	0.2696	0.2755	0.2828	0.2769	L1	x	0.2934	0.2993	0.3144	0.3087
	y	0.2786	0.2649	0.2760	0.2899		y	0.3152	0.3011	0.3011	0.3152

**Specific Lighting  
LTW-008RGB2-PH1**

Color Ranks Table											
Ranks	Color bin limits					Ranks	Color bin limits				
	$I_F$ : R=25mA, G=30mA, B=15mA						$I_F$ : R=25mA, G=30mA, B=15mA				
M1	x	0.3087	0.3144	0.3295	0.3239	KD	x	0.2815	0.2742	0.2890	0.2963
	y	0.3152	0.3011	0.3011	0.3152		y	0.2512	0.2404	0.2404	0.2512
K2	x	0.2841	0.2901	0.3051	0.2993	LD	x	0.2963	0.2890	0.3037	0.3111
	y	0.3011	0.2871	0.2871	0.3011		y	0.2512	0.2404	0.2404	0.2512
L2	x	0.2993	0.3051	0.3201	0.3144	MD	x	0.3111	0.3037	0.3183	0.3258
	y	0.3011	0.2871	0.2871	0.3011		y	0.2512	0.2404	0.2404	0.2512
M2	x	0.3144	0.3201	0.3352	0.3295	KE	x	0.2887	0.2815	0.2963	0.3036
	y	0.3011	0.2871	0.2871	0.3011		y	0.2621	0.2512	0.2512	0.2621
K3	x	0.2901	0.2960	0.3109	0.3051	LE	x	0.3036	0.2963	0.3111	0.3185
	y	0.2871	0.2730	0.2730	0.2871		y	0.2621	0.2512	0.2512	0.2621
L3	x	0.3051	0.3109	0.3259	0.3201	ME	x	0.3185	0.3111	0.3258	0.3333
	y	0.2871	0.2730	0.2730	0.2871		y	0.2621	0.2512	0.2512	0.2621
M3	x	0.3201	0.3259	0.3408	0.3352	KF	x	0.2960	0.2887	0.3036	0.3109
	y	0.2871	0.2730	0.2730	0.2871		y	0.2730	0.2621	0.2621	0.2730
KC	x	0.2742	0.2670	0.2817	0.2890	LF	x	0.3109	0.3036	0.3185	0.3259
	y	0.2404	0.2295	0.2295	0.2404		y	0.2730	0.2621	0.2621	0.2730
LC	x	0.2890	0.2817	0.2963	0.3037	MF	x	0.3259	0.3185	0.3333	0.3408
	y	0.2404	0.2295	0.2295	0.2404		y	0.2730	0.2621	0.2621	0.2730
MC	x	0.3037	0.2963	0.3108	0.3183						
	y	0.2404	0.2295	0.2295	0.2404						

Tolerance on each Hue (x, y) bin is +/- 0.01

**Specific Lighting  
LTW-008RGB2-PH1**

6.3 C.I.E 1931 Chromaticity Diagram for Color Ranks

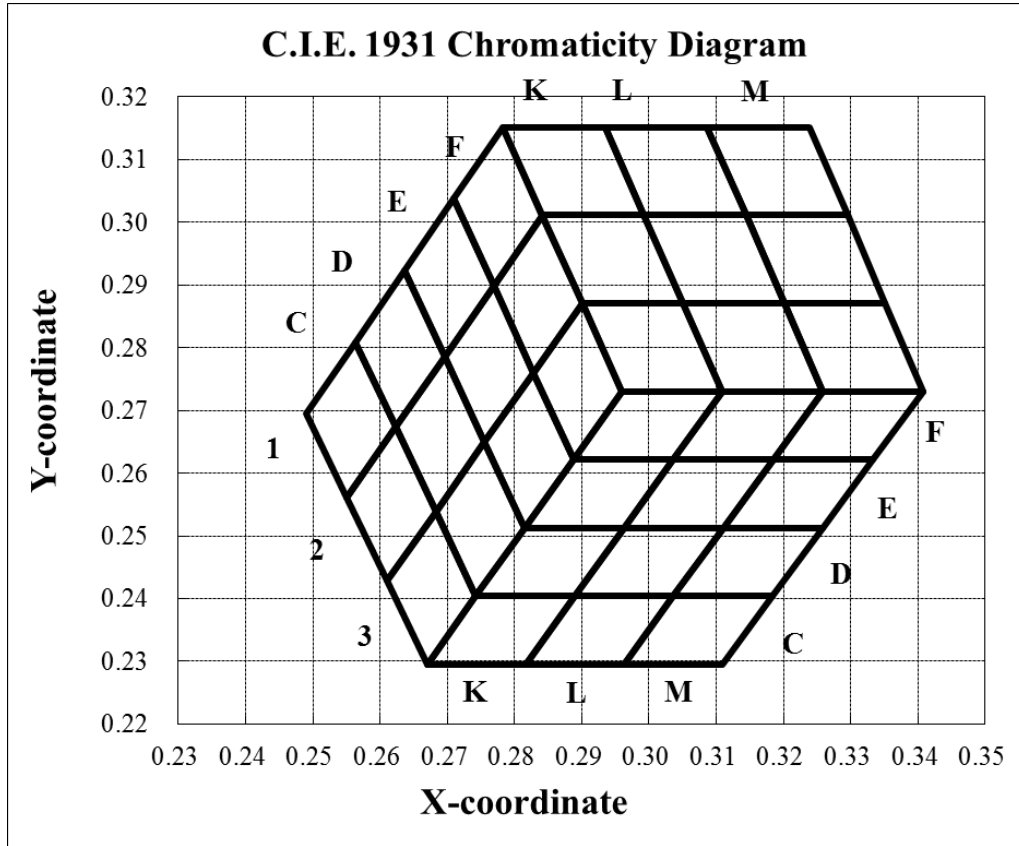

6.4 Shipping Label Code list

Shipping Label Code						
		Luminous Flux Ranks				
		W0	W1	W2	W3	W4
Color Ranks	C1	A1	B1	C1	D1	E1
	D1	A2	B2	C2	D2	E2
	E1	A3	B3	C3	D3	E3
	F1	A4	B4	C4	D4	E4
	C2	A5	B5	C5	D5	E5
	D2	A6	B6	C6	D6	E6
	E2	A7	B7	C7	D7	E7
	F2	A8	B8	C8	D8	E8

**Specific Lighting  
LTW-008RGB2-PH1**

Color Ranks	C3	A9	B9	C9	D9	E9
	D3	A10	B10	C10	D10	E10
	E3	A11	B11	C11	D11	E11
	F3	A12	B12	C12	D12	E12
	K1	A13	B13	C13	D13	E13
	L1	A14	B14	C14	D14	E14
	M1	A15	B15	C15	D15	E15
	K2	A16	B16	C16	D16	E16
	L2	A17	B17	C17	D17	E17
	M2	A18	B18	C18	D18	E18
	K3	A19	B19	C19	D19	E19
	L3	A20	B20	C20	D20	E20
	M3	A21	B21	C21	D21	E21
	KC	A22	B22	C22	D22	E22
	LC	A23	B23	C23	D23	E23
	MC	A24	B24	C24	D24	E24
	KD	A25	B25	C25	D25	E25
	LD	A26	B26	C26	D26	E26
	MD	A27	B27	C27	D27	E27
	KE	A28	B28	C28	D28	E28
	LE	A29	B29	C29	D29	E29
	ME	A30	B30	C30	D30	E30
	KF	A31	B31	C31	D31	E31
	LF	A32	B32	C32	D32	E32
MF	A33	B33	C33	D33	E33	



## Specific Lighting LTW-008RGB2-PH1

### 7. Typical Electrical / Optical Characteristics Curves (25°C Ambient Temperature Unless Otherwise Noted)

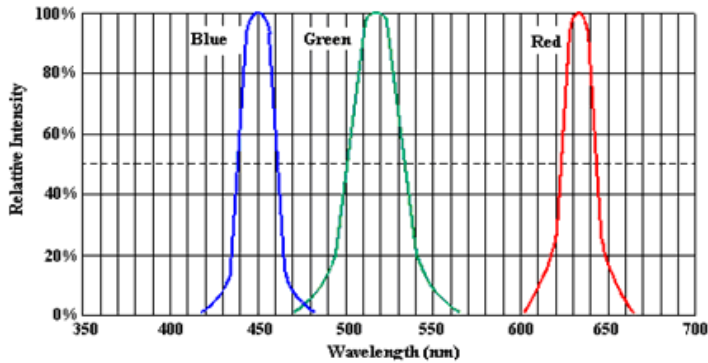

Fig. 1 Relative Intensity vs Dominant Wavelength

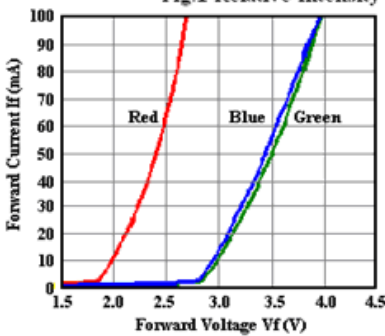

Fig. 2 Forward Current vs Forward Voltage

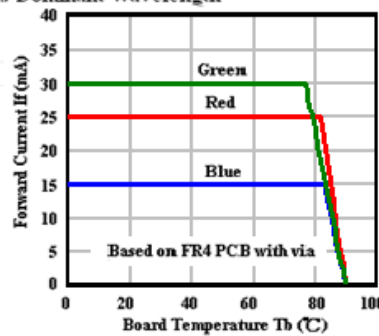

Fig. 3 Forward Current Derating Curve

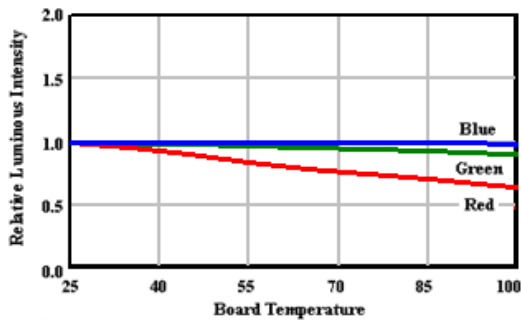

Fig. 5 Luminous Intensity vs Board Temperature  
(The characteristic curve are the same as R, G and B chip lighting up simultaneously)

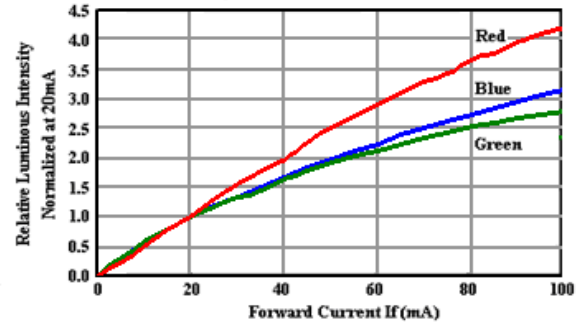

Fig. 4 Relative Luminous Intensity vs Forward Current

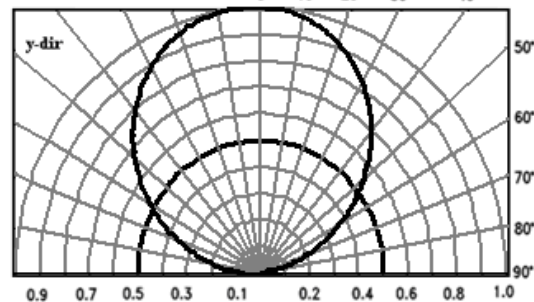
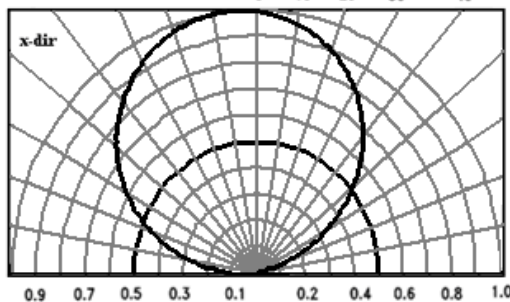
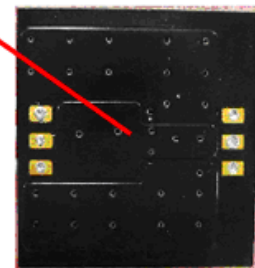
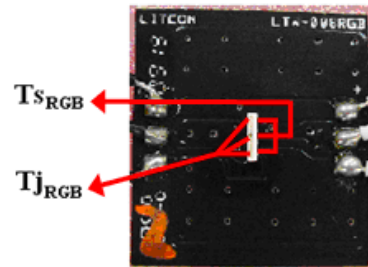

Fig. 6 Spatial Distribution



Ts: Soldering Pin Temperature

Tj: Junction Temperature

Tb: Board Temperature

## Specific Lighting LTW-008RGB2-PH1

### 8. Reliability Test Plan

#### 8.1 Reliability conditions

Item	Test Item	Condition	Duration	Sample Size
P1	Resistance to soldering heat (RTSH) JEITA ED-4701 300 301	IR soldering according attached lead free (Refer to J-STD-020D.1)	10sec/3x	3lots*30
P2	Steady state life test(SSLT)	Ta=60°C If (RGB)=25/30/15mA	20000hrs	3lots*30
P3	Pulse life test(PLT)	Ta=60°C If (RGB)= 25/30/15mA	20000hrs	3lots*30
P4	Temperature cycle (TC)	-20~25~85°C/ 30min each (20mins trans)	2500cycles	3lots*30
P5	Thermal shock (TS)	-40~105°C/5min each	100cycles	30
P6	High Temperature Storage (HTS)	100°C	1000hrs	30
P7	Low Temperature Storage (LTS)	-40°C	1000hrs	30
P8	High Temperature/High Humidity (WHTS)	85°C/85%	1000hrs	30

#### 8.2 Criteria for Judging the Damage

Item	Symbol	Test Condition	Criteria for Judgment	
			Min.	Max.
Forward Voltage	VF	IF =Typical Current		U.S.L. x 1.1
Luminous Flux	Lm	IF =Typical Current	L.S.L. x 0.5	
CCX & CCY (mixing white)	X,Y	IF =Typical Current		Shift<0.02

#### Notes

1. Operating life tests are mounted on thermal heat sink
2. Storage items are only component, not put on heat sink.

## Specific Lighting LTW-008RGB2-PH1

### 9. User Guide

#### 9.1 Cleaning

Do not use unspecified chemical liquid to clean LED they could harm the package.

If cleaning is necessary, immerse the LED in ethyl alcohol or isopropyl alcohol at normal temperature for less than one minute.

#### 9.2 Recommend Printed Circuit Board Attachment Pad

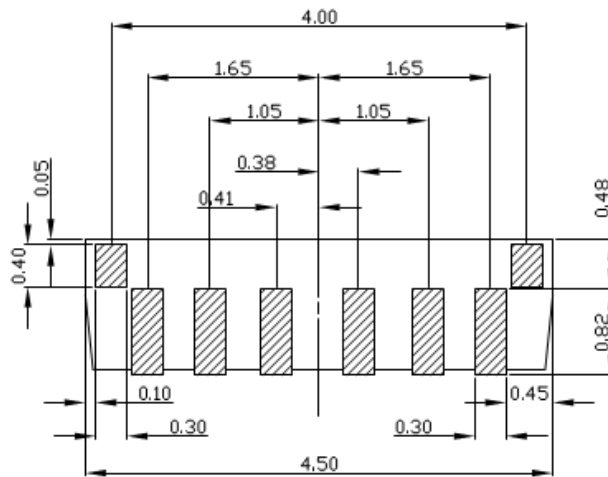

Infrared / vapor phase Reflow Soldering

#### 9.3 Package Dimensions of Tape

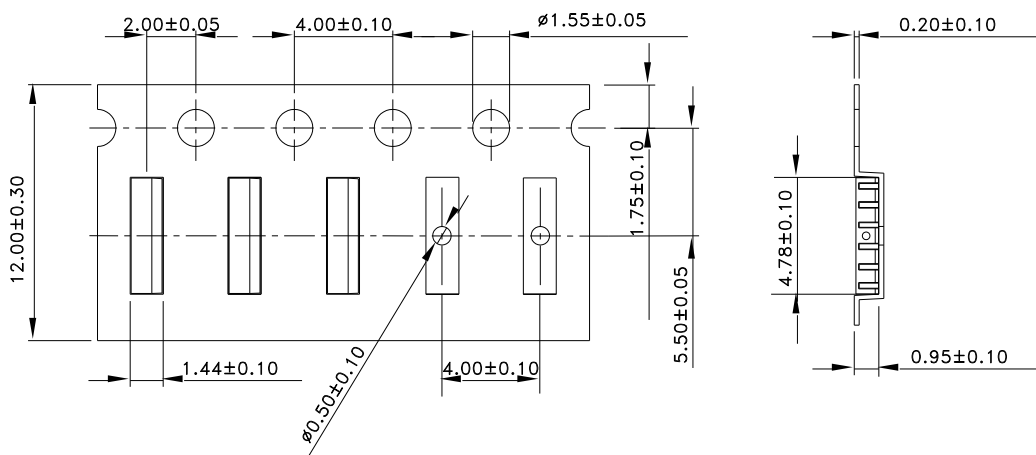

**Notes** All dimensions are in mm.

**Specific Lighting  
LTW-008RGB2-PH1**

9.4 Package Dimensions of Reel

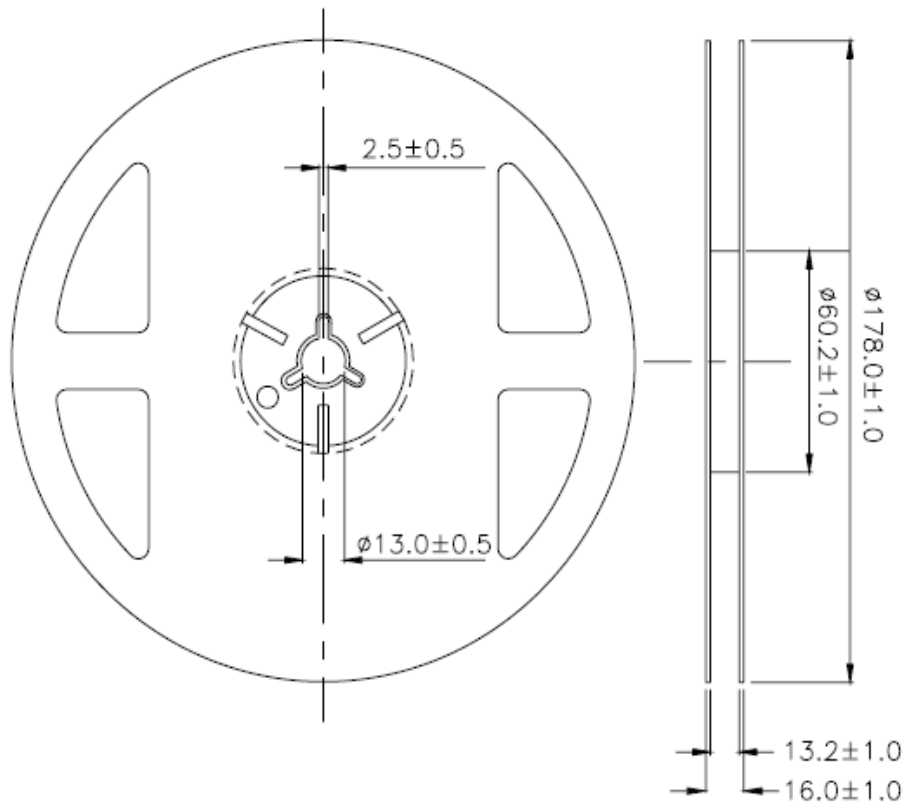

**Note:** Tolerances Unless Dimension  $\pm 0.1$ mm ,Unit = mm

The material of reel was PC.

**Notes**

1. Empty component pockets sealed with top cover tape.
2. 7 inch reel- maximum 2000 pieces per reel.
3. The maximum number of consecutive missing lamps is two.
4. In accordance with EIA-481-1-B specifications.

# Specific Lighting LTW-008RGB2-PH1

## 10. CAUTIONS

### 10.1 Application

The LEDs described here are intended to be used for ordinary electronic equipment (such as office equipment, communication equipment and household applications). Consult Liteon's Sales in advance for information on applications in which exceptional reliability is required, particularly when the failure or malfunction of the LEDs may directly jeopardize life or health (such as in aviation, transportation, traffic control equipment, medical and life support systems and safety devices).

### 10.2 Storage

This product is qualified as Moisture sensitive Level 3 per JEDEC J-STD-020 Precaution when handling this moisture sensitive product is important to ensure the reliability of the product.

The package is sealed:

The LEDs should be stored at 30°C or less and 90%RH or less. And the LEDs are limited to use within one year, while the LEDs is packed in moisture-proof package with the desiccants inside.

The package is opened:

The LEDs should be stored at 30°C or less and 60%RH or less. Moreover, the LEDs are limited to solder process within 168hrs. If the Humidity Indicator shows the pink color in 10% even higher or exceed the storage limiting time since opened, that we recommended to baking LEDs at 60°C at least 48hrs. To seal the remainder LEDs return to package, it's recommended to be with workable desiccants in original package.

### 10.3 Cleaning

Use alcohol-based cleaning solvents such as isopropyl alcohol to clean the LED if necessary.

### 10.4 Soldering

Recommended soldering conditions:

Reflow soldering		Soldering iron	
Pre-heat	120~150°C	Temperature	300°C Max.
Pre-heat time	120 sec. Max.	Soldering time	3 sec. Max.
Soldering Temp.	260°C Max.		(one time only)
Soldering time	30 sec. Max.		

## Specific Lighting LTW-008RGB2-PH1

### 10.5 Drive Method

An LED is a current-operated device. In order to ensure intensity uniformity on multiple LEDs connected in parallel in an application, it is recommended that a current limiting resistor be incorporated in the drive circuit, in series with each LED as shown in Circuit A below.

**Circuit model A**

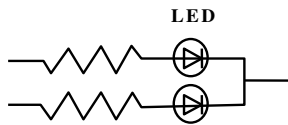

(A) Recommended circuit.

**Circuit model B**

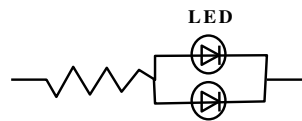

(B) The brightness of each LED might appear different due to the differences in the I-V characteristics of those LEDs.

### 10.6 ESD (Electrostatic Discharge)

Static Electricity or power surge will damage the LED.

Suggestions to prevent ESD damage:

- Use of a conductive wrist band or anti-electrostatic glove when handling these LEDs.
- All devices, equipment, and machinery must be properly grounded.
- Work tables, storage racks, etc. should be properly grounded.
- Use ion blower to neutralize the static charge which might have built up on surface of the LED's plastic lens as a result of friction between LEDs during storage and handling.

ESD-damaged LEDs will exhibit abnormal characteristics such as high reverse leakage current, low forward voltage, or "no light-up" at low currents.

To verify for ESD damage, check for "light-up" and  $V_f$  of the suspect LEDs at low currents.

The  $V_f$  of "good" LEDs should be  $>2.0V@0.1mA$  for InGaN product

## Specific Lighting LTW-008RGB2-PH1

### 11. Suggested Checking List

#### ■ Training and Certification

1. Everyone working in a static-safe area is ESD-certified?
2. Training records kept and re-certification dates monitored?

#### ■ Static-Safe Workstation & Work Areas

1. Static-safe workstation or work-areas have ESD signs?
2. All surfaces and objects at all static-safe workstation and within 1 ft measure less than 100V?
3. All ionizer activated, positioned towards the units?
4. Each work surface mats grounding is good?

#### ■ Personnel Grounding

1. Every person (including visitors) handling ESD sensitive (ESDS) items wear wrist strap, heel strap or conductive shoes with conductive flooring?
2. If conductive footwear used, conductive flooring also present where operator stand or walk?
3. Garments, hairs or anything closer than 1 ft to ESD items measure less than 100V\*?
4. Every wrist strap or heel strap/conductive shoes checked daily and result recorded for all DLs?
5. All wrist strap or heel strap checkers calibration up to date?

Note: \*50V for Blue LED.

#### ■ Device Handling

1. Every ESDS items identified by EIA-471 labels on item or packaging?
2. All ESDS items completely inside properly closed static-shielding containers when not at static-safe workstation?
3. No static charge generators (e.g. plastics) inside shielding containers with ESDS items?
4. All flexible conductive and dissipative package materials inspected before reuse or recycle?

#### ■ Others

1. Audit result reported to entity ESD control coordinator?
2. Corrective action from previous audits completed?
3. Are audit records complete and on file?

**Specific Lighting  
LTW-008RGB2-PH1**

**12. Revision Information**

Version	Page	Content of Change	Date Record
A	1	The package layout changed.	2010/05/05
B	3, 4	1. Red min. lumen spec modify from 1.61 to 1.70 2. White min. lumen spec modify form 6.32 to 6.41 (Based on Red min lumen modify) 3. Green max. Vf spec modify from 3.6 to 3.55	2010/05/07
C	1, 6, 7	1. New design solder pin of lead frame modify. 2. Typical electrical / optical characteristics curves modify.	2010/07/13
D	3, 4, 5	Luminous flux and color spec modify.	2010/08/24
E	1, 3, 10	1. Add the dimensions of pick-up area. 2. Green max. Vf spec modify from 3.65 to 3.55 3. Duration time for RA test modify. (follow 2K10)	2010/10/22
F	6	Add shipping label code list	2010/12/08
G	4, 5, 6	Color spec modify	2011/01/24
H	3	Green max. Vf spec modify from 3.55 to 3.6	2012/05/08
I	4, 5, 6, 7, 8	1. Min. lumen spec modify 2. Color spec modify	2014/11/21
J	2	Modify solder pins description	2015/09/14