

**PLUG MATED TO R/A RECEPTACLE
MATED PROFILE**

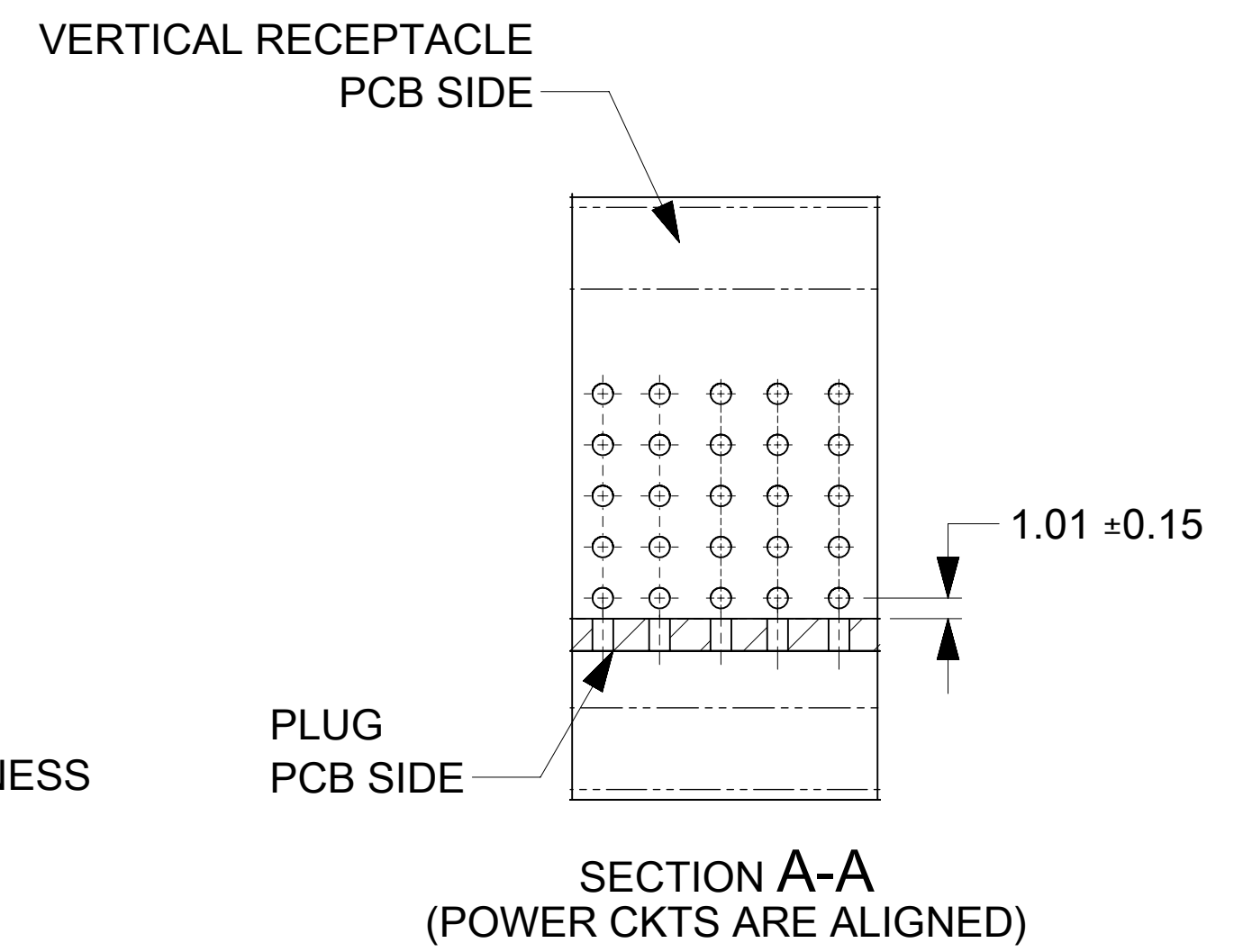

**PLUG MATED TO VERTICAL RECEPTACLE
MATED PROFILE**

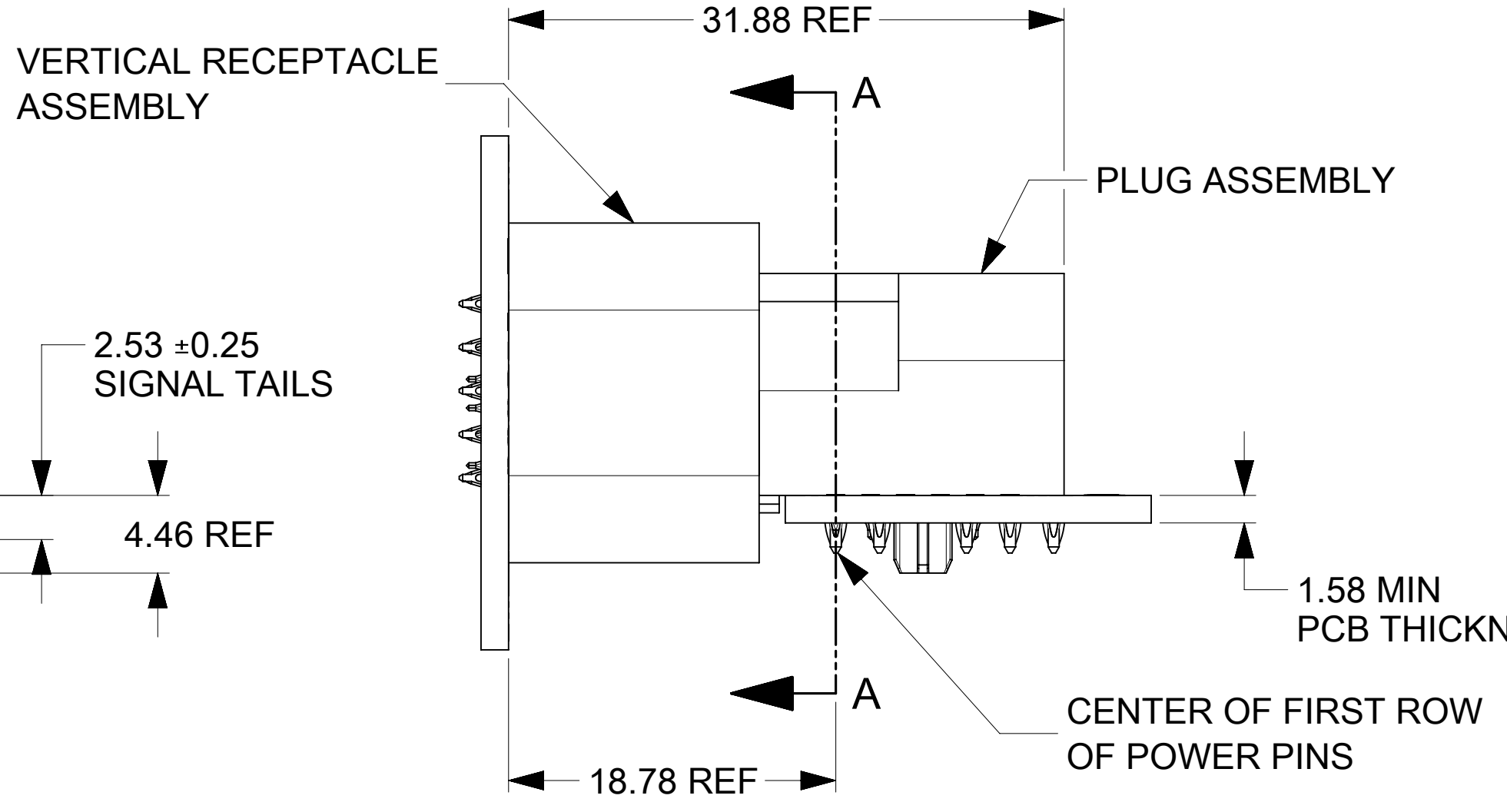
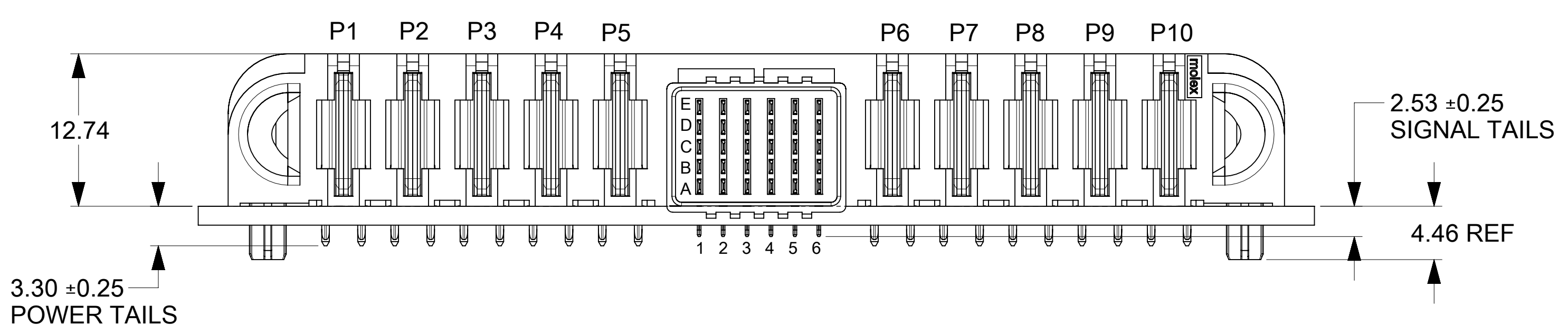
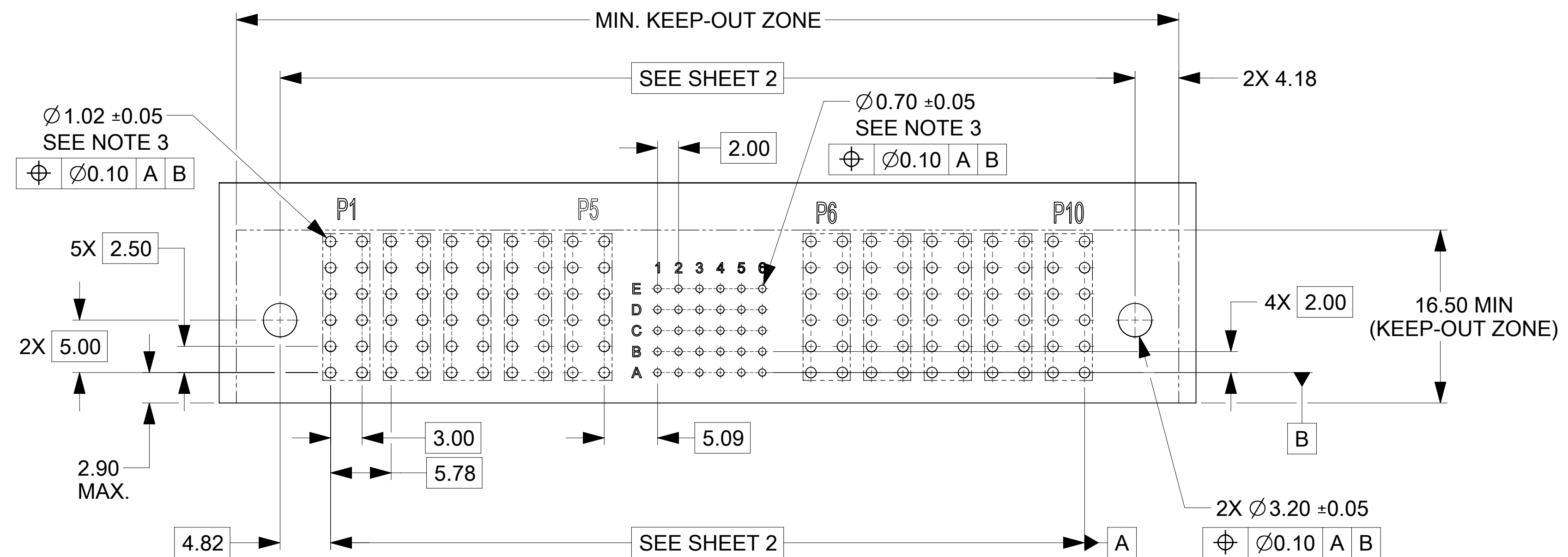

RECOMMENDED PCB LAYOUT AND KEEP-OUT ZONE

- NOTES:**
- MATERIAL:**
 - HOUSINGS: LCP UL94, V-0, COLOR : BLACK
 - TERMINALS: HIGH CONDUCTIVITY COPPER ALLOY
 - PLATING: 1.27 µm (50 µin) NICKEL OVERALL WITH 2.54 µm (100 µin) SELECTIVE TIN ON TAILS AND 0.762 µm (30 µin) SELECTIVE GOLD ON CONTACT AREA
 - PACKAGING:** ASSEMBLIES TO BE TRAY PACKED PER PACKAGING SPEC: 2141130010-PK.
 - PLATED THRU HOLE SIZE,** REFER TO PRODUCT SPEC. FOR DETAILS.
 - PRODUCT SPEC:** 2141130000-PS.
 - PRODUCT TO MEET** RoHS REQUIREMENTS.
 - PLUG ASSEMBLY MATES TO MOLEX RECEPTACLES** 219563XXXX-SD AND 219564XXXX-SD, SEE DRAWINGS FOR DETAILS.
 - TAIL DESIGN:** COMPLIANT PIN.
 - POWER TERMINALS AND SIGNALS ARE LUBRICATED.**
 - APPLICATION SPECIFICATION:** 2141130000-AS (FOR COMPLIANT TAILS ONLY).

THIS DRAWING CONTAINS INFORMATION THAT IS PROPRIETARY TO MOLEX ELECTRONIC TECHNOLOGIES, LLC AND SHOULD NOT BE USED WITHOUT WRITTEN PERMISSION			
DIMENSION UNITS	SCALE	CURRENT REV DESC:	
mm	3:1		
GENERAL TOLERANCES (UNLESS SPECIFIED)			
ANGULAR TOL	± °	EC NO: 745288	
4 PLACES	±	DRWN: LZABJANOVSKI	2023/03/09
3 PLACES	±	CHK'D: JAYK1	2023/04/10
2 PLACES	± 0.25	APPR: JAYK1	2023/04/10
1 PLACE	± 0.3	INITIAL REVISION:	
0 PLACES	±	DRWN: LZABJANOVSKI	2022/03/28
DRAFT WHERE APPLICABLE MUST REMAIN WITHIN DIMENSIONS		APPR: BPISZCZOR	2022/08/04
THIRD ANGLE PROJECTION		DRAWING	SERIES
D-SIZE		219562	
MATERIAL NUMBER		CUSTOMER	SHEET NUMBER
SEE CHART			1 OF 2



GUARDIAN HD RA PLUG DUAL POWER
SIGNAL CENTER PF

PRODUCT CUSTOMER DRAWING

DOCUMENT NUMBER	DOC TYPE	DOC PART	REVISION
2195629002-SD	PSD	000	A1

PART NUMBER	CONFIGURATION	QUANTITY PER CARTON (DU)
219562-0021	G+1P+15S+1P+G	105

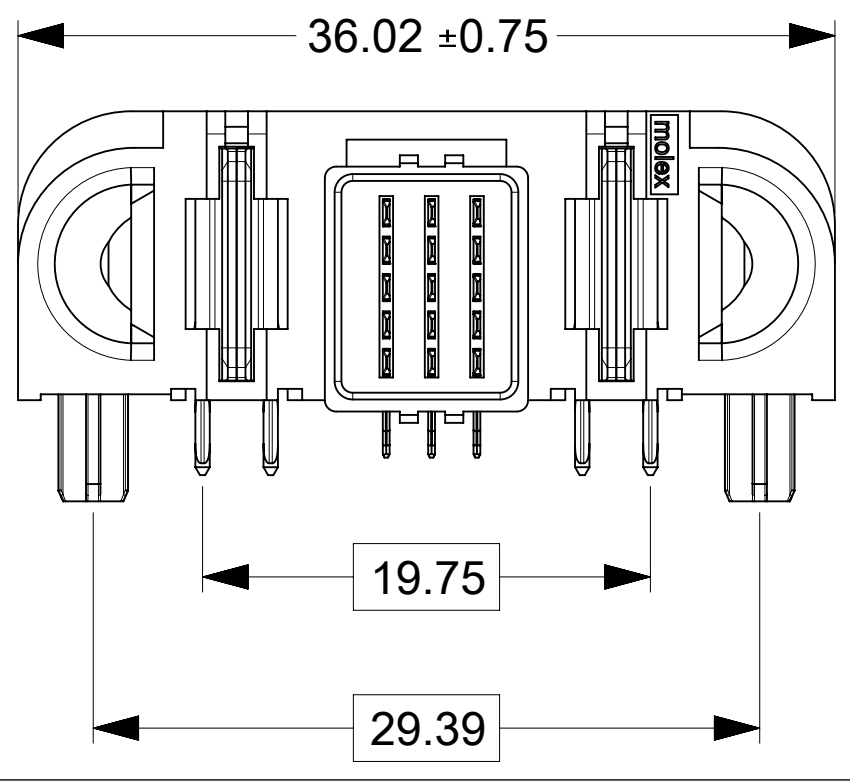

PART NUMBER	CONFIGURATION	QUANTITY PER CARTON (DU)
219562-0022	G+2P+15S+2P+G	75

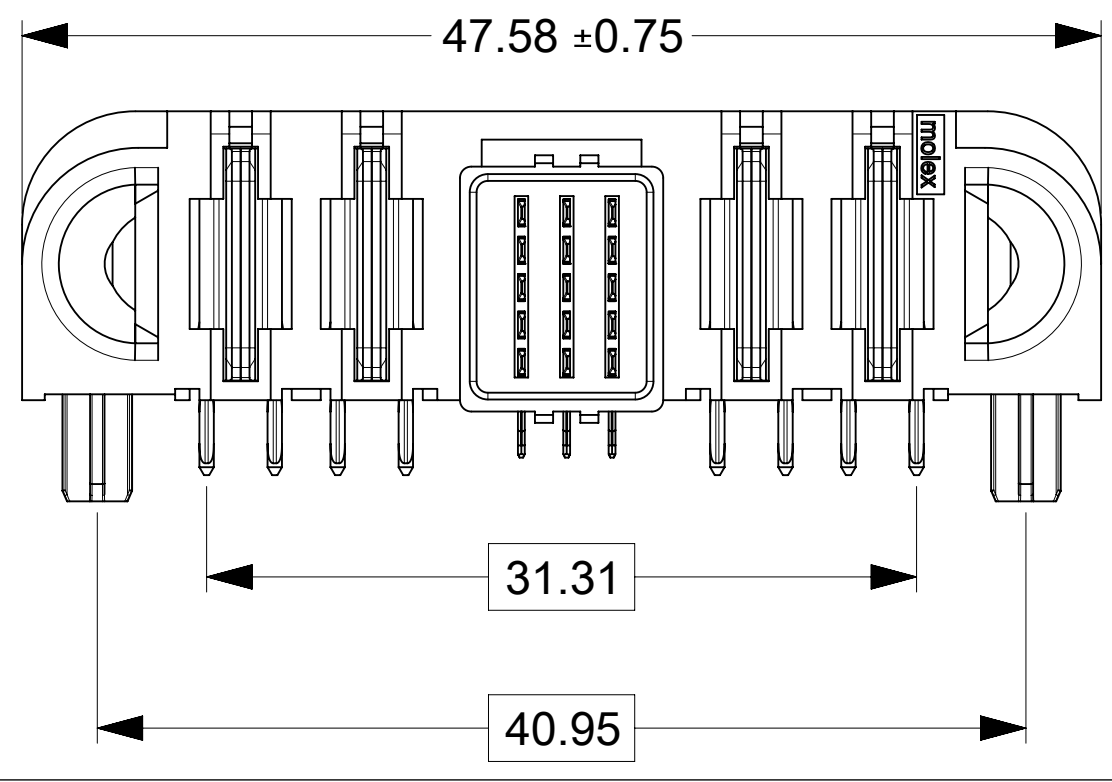

PART NUMBER	CONFIGURATION	QUANTITY PER CARTON (DU)
219562-0023	G+3P+15S+3P+G	60

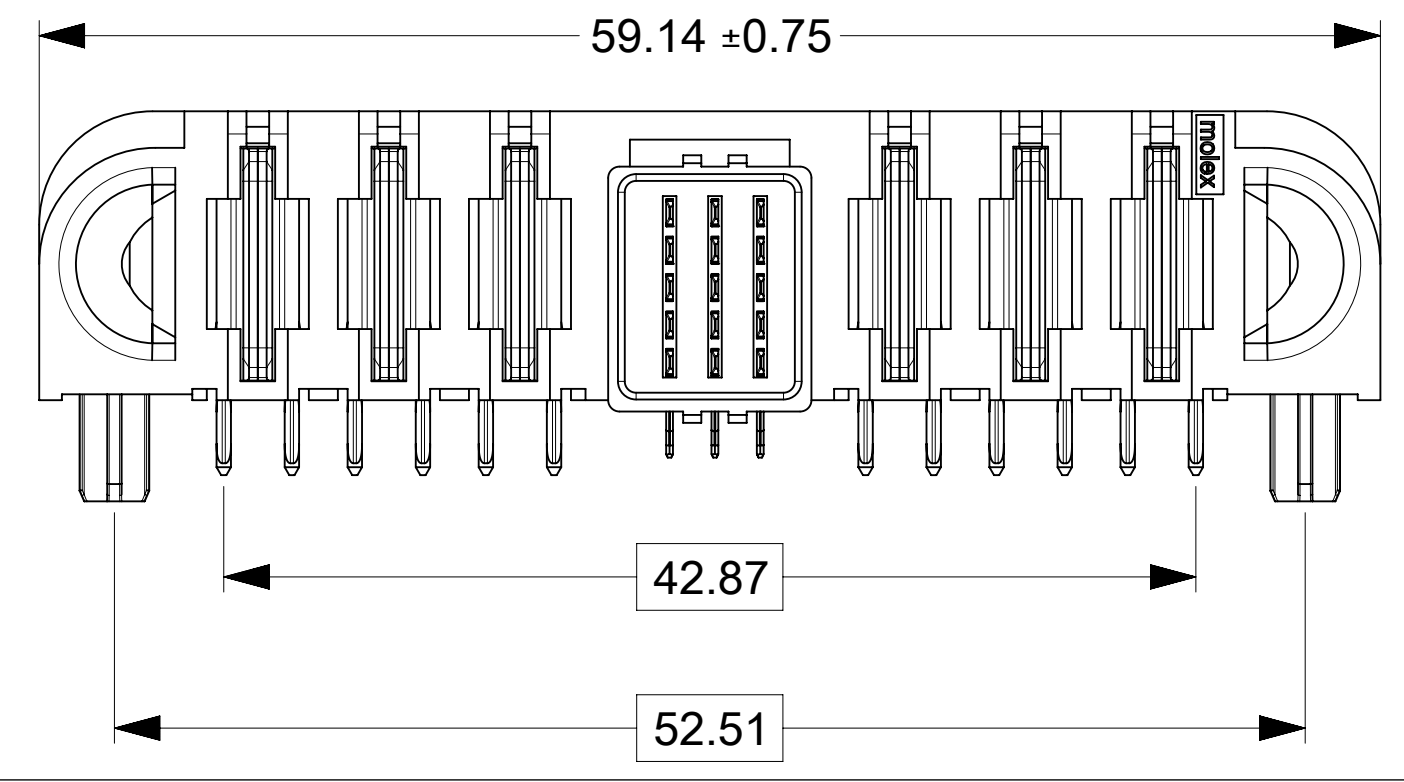

PART NUMBER	CONFIGURATION	QUANTITY PER CARTON (DU)
219562-0024	G+4P+15S+4P+G	45

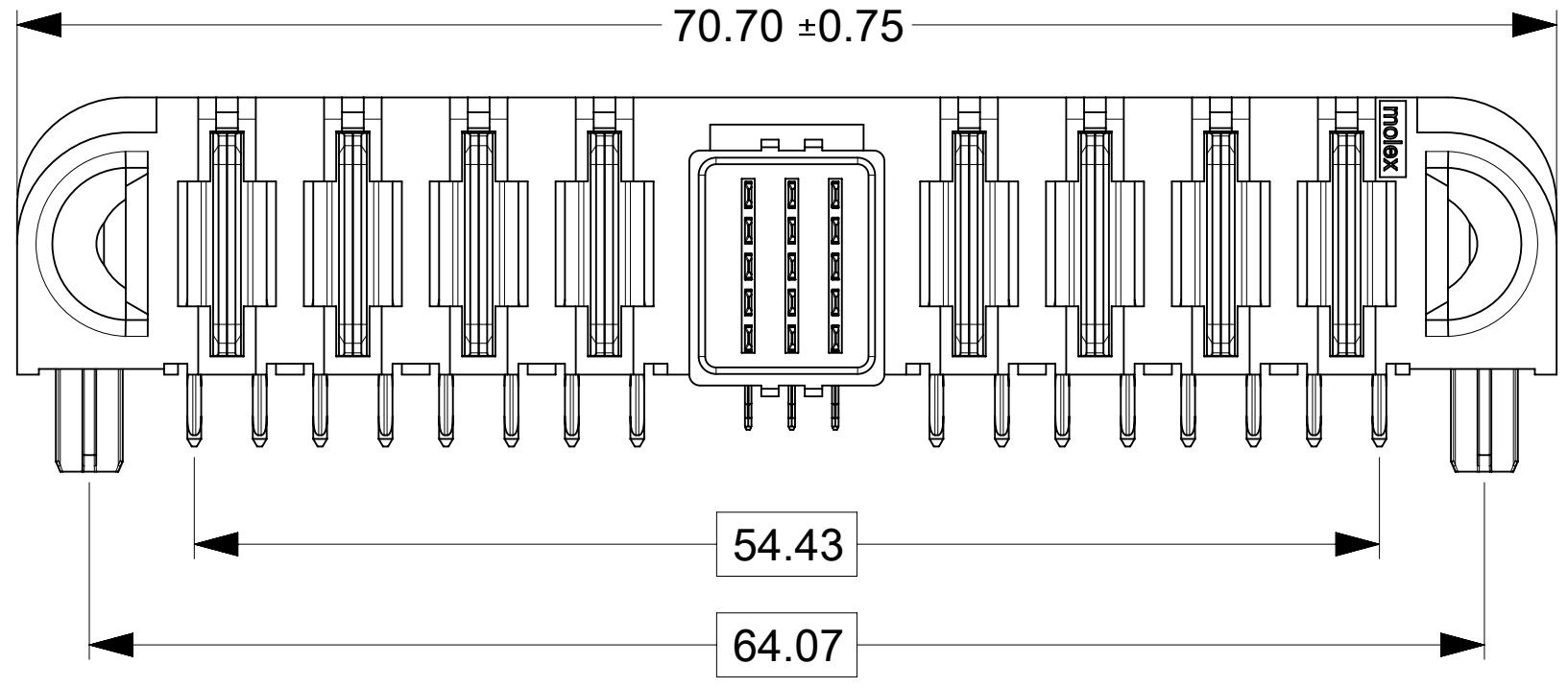

PART NUMBER	CONFIGURATION	QUANTITY PER CARTON (DU)
219562-0025	G+5P+15S+5P+G	45

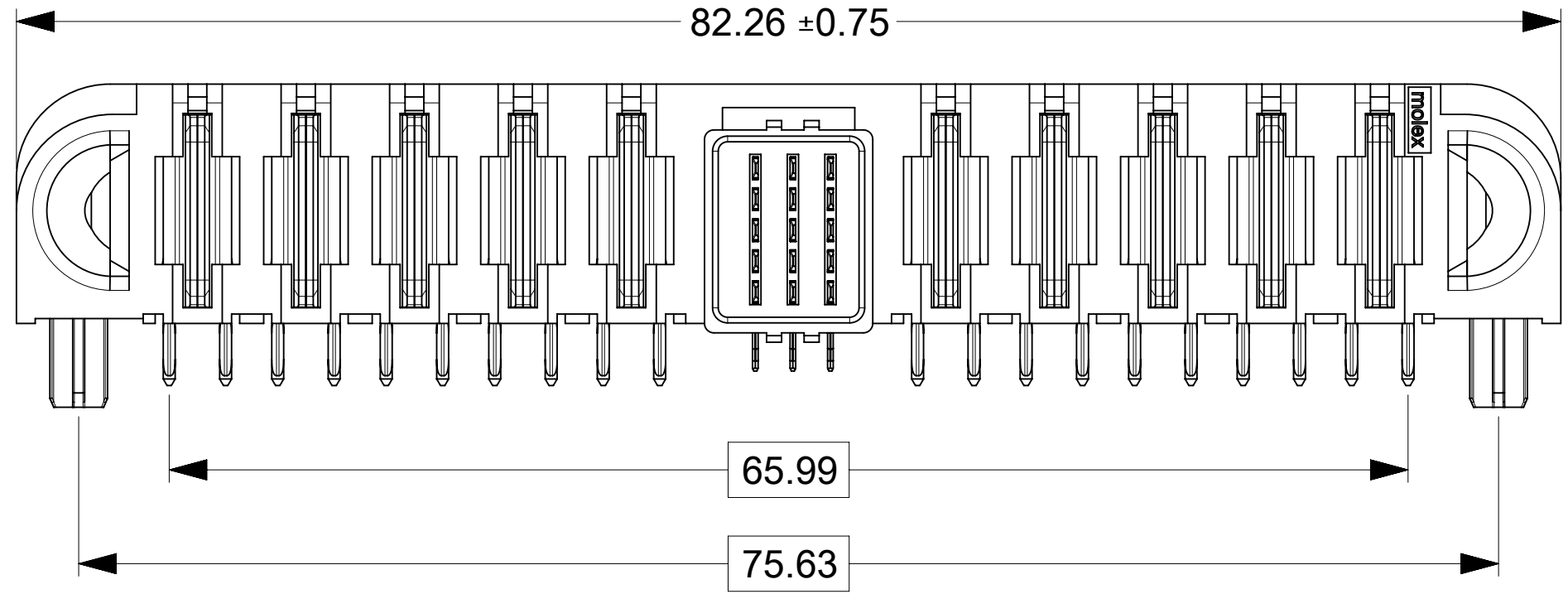

PART NUMBER	CONFIGURATION	QUANTITY PER CARTON (DU)
219562-0026	G+1P+30S+1P+G	90

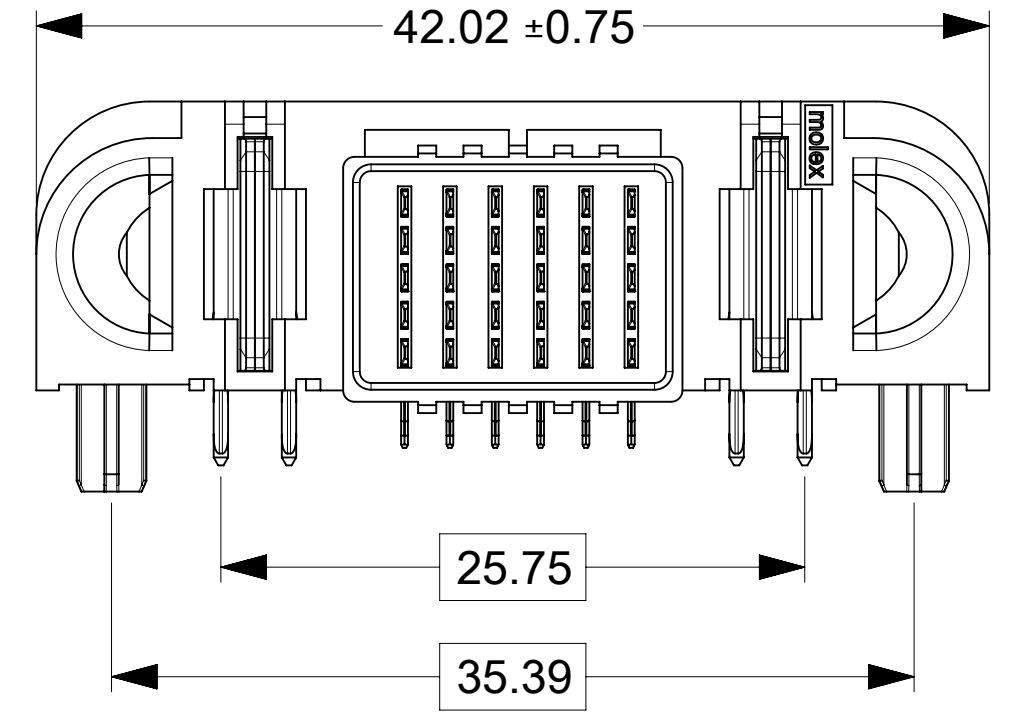

PART NUMBER	CONFIGURATION	QUANTITY PER CARTON (DU)
219562-0027	G+2P+30S+2P+G	60

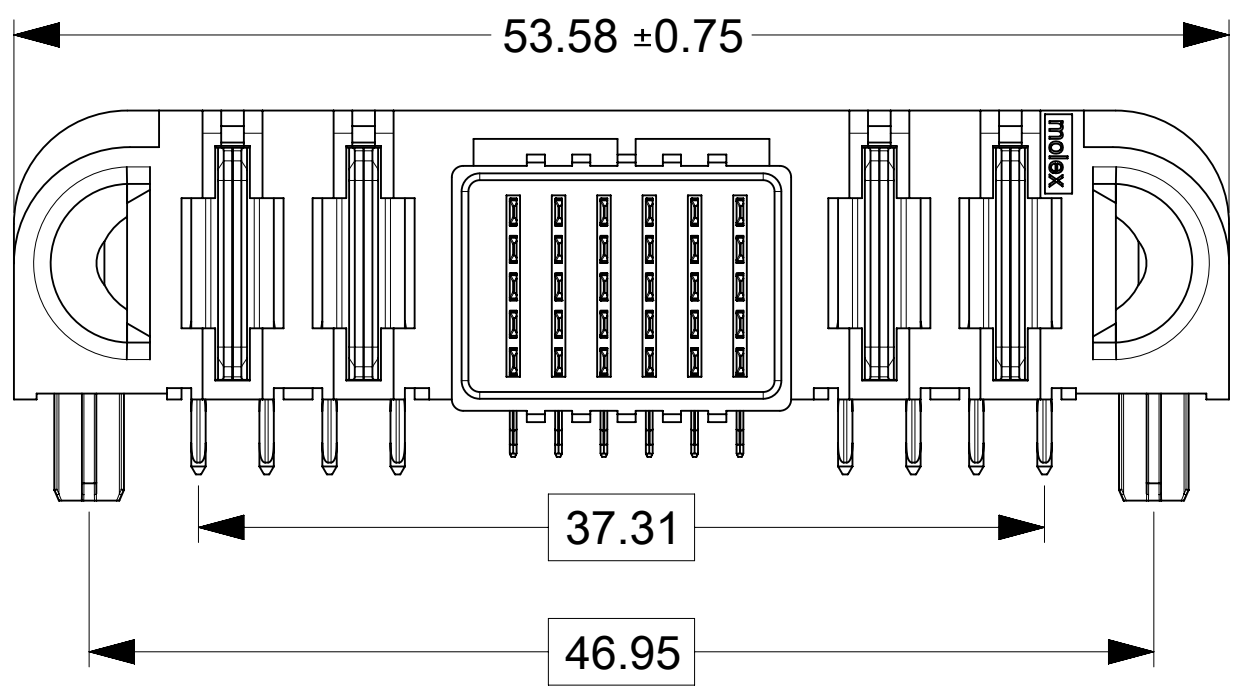

PART NUMBER	CONFIGURATION	QUANTITY PER CARTON (DU)
219562-0028	G+3P+30S+3P+G	45

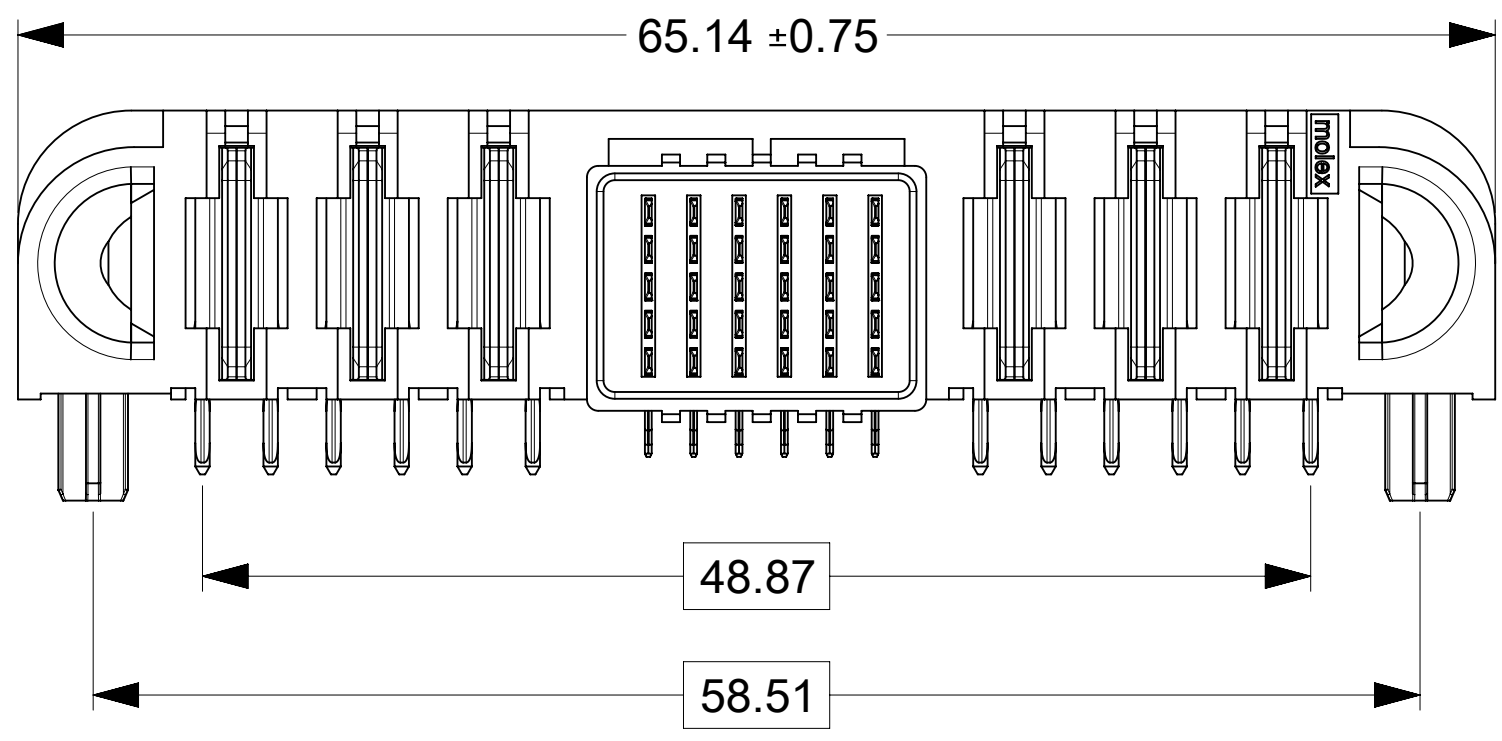

PART NUMBER	CONFIGURATION	QUANTITY PER CARTON (DU)
219562-0029	G+4P+30S+4P+G	45

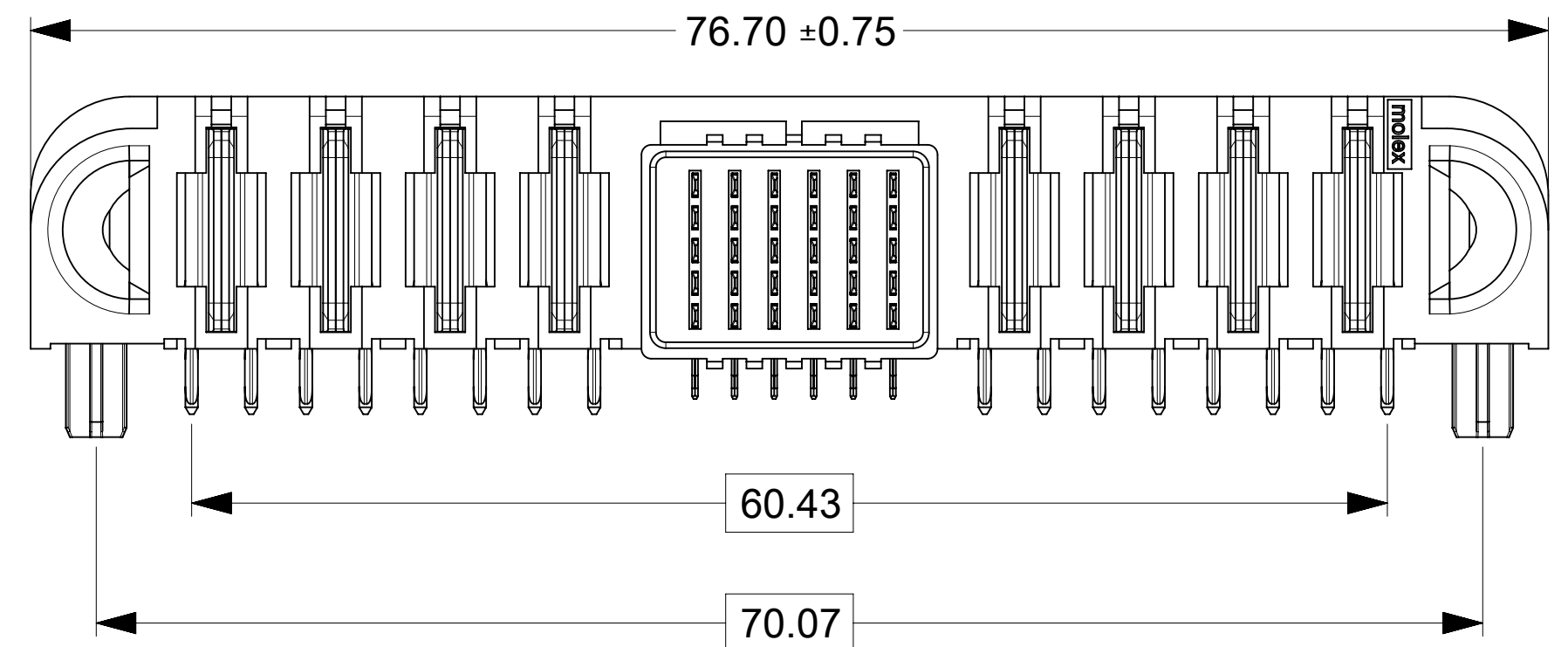

PART NUMBER	CONFIGURATION	QUANTITY PER CARTON (DU)
219562-0030	G+5P+30S+5P+G	30

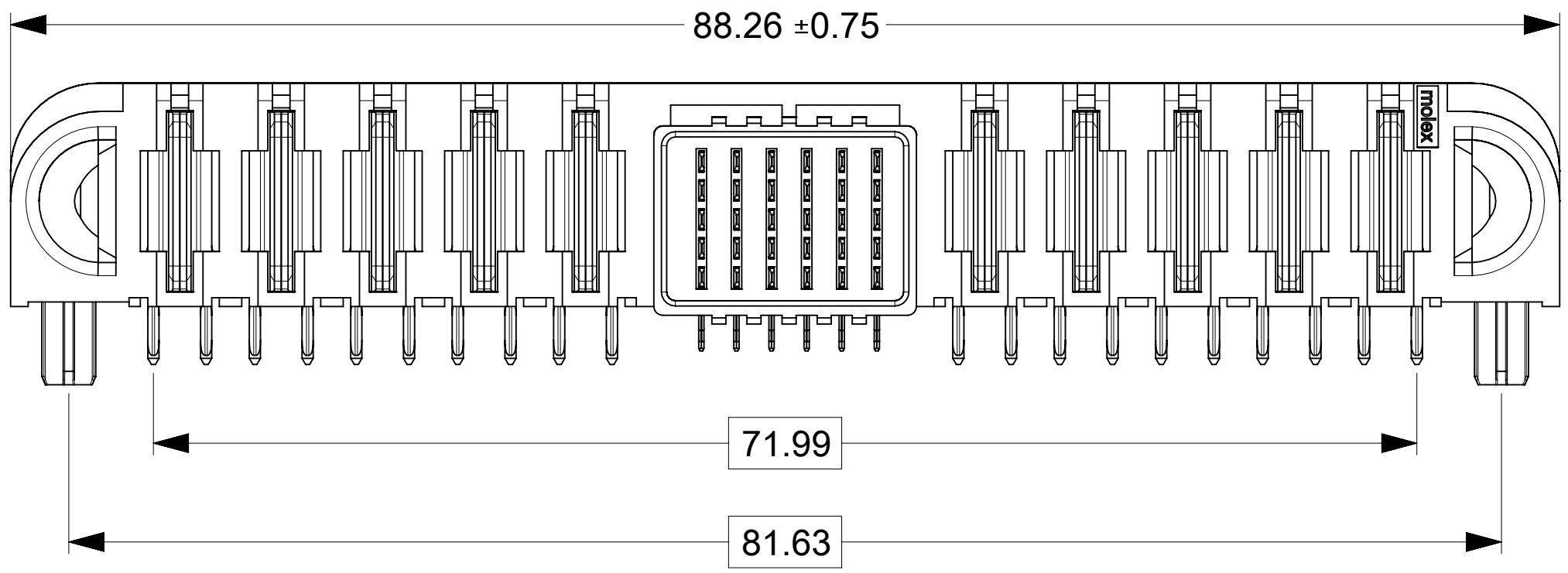

THIS DRAWING CONTAINS INFORMATION THAT IS PROPRIETARY TO MOLEX ELECTRONIC TECHNOLOGIES, LLC AND SHOULD NOT BE USED WITHOUT WRITTEN PERMISSION

DIMENSION UNITS	SCALE	CURRENT REV DESC:
mm	3:1	
GENERAL TOLERANCES (UNLESS SPECIFIED)		
ANGULAR TOL	±	°
4 PLACES	±	
3 PLACES	±	
2 PLACES	±	0.25
1 PLACE	±	0.3
0 PLACES	±	
DRAFT WHERE APPLICABLE MUST REMAIN WITHIN DIMENSIONS	THIRD ANGLE PROJECTION	DRAWING SERIES
		D-SIZE 219562

EC NO: 745288	2023/03/09
DRWN: LZABJANOVSKI	2023/04/10
CHK'D: JAYK1	2023/04/10
APPR: JAYK1	2023/04/10
INITIAL REVISION:	
DRWN: LZABJANOVSKI	2022/03/28
APPR: BPISZCZOR	2022/08/04

DOCUMENT NUMBER			DOC TYPE	DOC PART	REVISION
2195629002-SD			PSD	000	A1
MATERIAL NUMBER		CUSTOMER		SHEET NUMBER	
SEE CHART				2 OF 2	

molex

GUARDIAN HD RA PLUG DUAL POWER SIGNAL CENTER PF

PRODUCT CUSTOMER DRAWING