

GlobTek, Inc. www.globtek.com 186 Veterans Drive, Northvale, NJ 07647 Tel. (201) 784-1000 Fax (201) 784-0111	Drawing Title: GTM91110P24012-FA-S, Medical Power Supply, Efficiency Level: , Case Color/Style: PCB, Open Frame/Internal, Regulated Switchmode AC-DC Power Supply AC Adaptor, Input Rating: 100-240V~, 50-60 Hz, PCB Pins , Output Rating: 240W, 12.0V@20.0A, Output Configuration: N/A mm, N/A/6 Cond, , MOLEX 6-PIN FRICTION LOCK HEADER P/N 26-60-4060 MATES WITH PN: 09-50-3061, Ferrite: None, N/A, GT Cord # C1196, Pin Out: Pins 1,2,3: V+, Pins 4,5,6: Common, Blades/Input Cord: Not Applicable, Approvals: WEEE; VCCI; Ukraine; FCC; China RoHS; RoHS; EAC; Book 60601; Class I; ETL; cETLus 60950-1; cETLus 60601; SIQ; SIQ; CE; ETL;	
	Model No. GTM91110P24012-FA-S	
	Part No./Ordering No. GTM91110P24012FSIM(R)	Rev C

In Addition to GlobTek Inc.'s renewed ISO9001:2015 - Quality Management System Certification, GlobTek Inc. is now certified to:

ISO13485:2016 - Medical Devices Quality Management System Certification

ISO14001:2015 - Environmental Management System Certification

ISO Certificates are available online at <https://www.globtek.com/iso-certificates/>

The acceptance of this specification and use of the product described in this document indicates the acceptance and binding of the customer to Globtek TERMS AND CONDITIONS (attached to the end of this document), which supersede all other agreements, terms, and conditions (<https://en.globtek.com/terms-and-conditions/>).

The purchaser of this product (Customer) agrees that it is their sole responsibility to determine suitability/fitness of the product described in this specification for their application and to take precautions for protection against any hazards attendant to the handling and use of the product.

Footnote:

GlobTek Inc. will not be liable for the safety and performance of these power supplies/battery packs if unauthorized access and repair occurs. End user should consult applicable UL, CSA or EN standards for proper installation instruction.

Limitation of Use:

GlobTek products are intended for use with commercial, medical, and/or industrial equipment only. GlobTek product are not authorized for use as mission critical components in life support hazardous environment, nuclear or aircraft applications without prior written approval from the CEO of GlobTek Inc.

Contents of this document are subject to change without prior notice.

### Customer Approval of Specification:

Please approve, sign and send back to GlobTek so we can complete order processing.

A delay in receipt of this form will delay delivery schedule.

Company Name: _____	Customer P/N: _____
Quote Number: _____	Date: _____
Authorized Representative Name: _____	Authorized Representative Signature: _____

<b>GlobTek, Inc.</b> www.globtek.com 186 Veterans Drive, Northvale, NJ 07647 Tel. (201) 784-1000 Fax (201) 784-0111	Drawing Title: GTM91110P24012-FA-S, Medical Power Supply, Efficiency Level: , Case Color/Style: PCB, Open Frame/Internal, Regulated Switchmode AC-DC Power Supply AC Adaptor, Input Rating: 100-240V~, 50-60 Hz, PCB Pins , Output Rating: 240W, 12.0V@20.0A, Output Configuration: N/A mm, N/A/6 Cond, , MOLEX 6-PIN FRICTION LOCK HEADER P/N 26-60-4060 MATES WITH PN: 09-50-3061, Ferrite: None, N/A, GT Cord # C1196, Pin Out: Pins 1,2,3: V+, Pins 4,5,6: Common, Blades/Input Cord: Not Applicable, Approvals: WEEE; VCCI; Ukraine; FCC; China RoHS; RoHS; EAC; Book 60601; Class I; ETL; cETLus 60950-1; cETLus 60601; SIQ; SIQ; CE; ETL;	
	Model No. GTM91110P24012-FA-S	
	Part No./Ordering No. GTM91110P24012FSIM(R)	Rev C

## REVISION HISTORY

REV	DESCRIPTION	SUB	DATE	APPROVED
C	Update to SF format, update approvals on the label	QA	08/15/2018	QA

### POWER SUPPLY INFORMATION

TYPE	Open Frame/Internal
TECHNOLOGY	Regulated Switchmode AC-DC Power Supply AC Adaptor
CASE COLOR	PCB
NAMEPLATE RATED INPUT	100-240V~, 50-60 Hz, 4.0
INPUT CONFIG	PCB Pins
WATTS	240.00
VOLTS OUT	12.0
CURRENT OUT (Amps)	20.0
BLADE/CORD INCLUDED	N/A Not Applicable
BLADE/CORD INSTALLED	N/A :Not Applicable
INGRESS PROTECTION	
GROUNDING CONFIGURATION	(E1) Earthed output
EFFICIENCY LEVEL	
OUTPUT CONFIGURATION	N/A mm, N/A/6 Cond, , MOLEX 6-PIN FRICTION LOCK HEADER P/N 26-60-4060 MATES WITH PN: 09-50-3061, Ferrite: None, N/A, GT Cord # C1196
CONNECTOR PIN OUT	Pins 1,2,3: V+, Pins 4,5,6: Common
LABEL SPECS	Standard GT,L-1186
SPECIAL BARCODE LABEL MATERIAL	No
PACK SPEC	Standard OF, Individually Box
USER MANUAL	N/A User Manual

#### PROPRIETARY INFORMATION

PROPRIETARY OF GLOBTEK, INC. ANY REPRODUCTION, DISCLOSURE OR USE OF THIS DRAWING, IN WHOLE OR IN PART, IS HEREBY PROHIBITED EXCEPT AS SPECIFIED IN WRITING BY GLOBTEK, INC. © GlobTek, Inc. 2012 - 2023

GlobTek, Inc. www.globtek.com 186 Veterans Drive, Northvale, NJ 07647 Tel. (201) 784-1000 Fax (201) 784-0111	Drawing Title: GTM91110P24012-FA-S, Medical Power Supply, Efficiency Level: , Case Color/Style: PCB, Open Frame/Internal, Regulated Switchmode AC-DC Power Supply AC Adaptor, Input Rating: 100-240V~, 50-60 Hz, PCB Pins , Output Rating: 240W, 12.0V@20.0A, Output Configuration: N/A mm, N/A/6 Cond, , MOLEX 6-PIN FRICTION LOCK HEADER P/N 26-60-4060 MATES WITH PN: 09-50-3061, Ferrite: None, N/A, GT Cord # C1196, Pin Out: Pins 1,2,3: V+, Pins 4,5,6: Common, Blades/Input Cord: Not Applicable, Approvals: WEEE; VCCI; Ukraine; FCC; China RoHS; RoHS; EAC; Book 60601; Class I; ETL; cETLus 60950-1; cETLus 60601; SIQ; SIQ; CE; ETL;	
	Model No. GTM91110P24012-FA-S	
	Part No./Ordering No. GTM91110P24012FSIM(R)	Rev C

Notes/Modifications/Customizations (notes in this section supersede the values shown in the standard spec)  
DIMENSIONS ARE IN MM UNLESS SPECIFIED OTHERWISE

GlobTek, Inc. www.globtek.com 186 Veterans Drive, Northvale, NJ 07647 Tel. (201) 784-1000 Fax (201) 784-0111	Drawing Title: GTM91110P24012-FA-S, Medical Power Supply, Efficiency Level: , Case Color/Style: PCB, Open Frame/Internal, Regulated Switchmode AC-DC Power Supply AC Adaptor, Input Rating: 100-240V~, 50-60 Hz, PCB Pins , Output Rating: 240W, 12.0V@20.0A, Output Configuration: N/A mm, N/A/6 Cond, , MOLEX 6-PIN FRICTION LOCK HEADER P/N 26-60-4060 MATES WITH PN: 09-50-3061, Ferrite: None, N/A, GT Cord # C1196, Pin Out: Pins 1,2,3: V+, Pins 4,5,6: Common, Blades/Input Cord: Not Applicable, Approvals: WEEE; VCCI; Ukraine; FCC; China RoHS; RoHS; EAC; Book 60601; Class I; ETL; cETLus 60950-1; cETLus 60601; SIQ; SIQ; CE; ETL;	
	Model No. GTM91110P24012-FA-S	
	Part No./Ordering No. GTM91110P24012FSIM(R)	Rev C

## ELECTRICAL SPECIFICATIONS

### A) ELECTRICAL SPECIFICATIONS:

01. Input Voltage: Specified 90-264 Vac, Nameplate rated 100-240 Vac
02. Input Frequency: Specified 47-63 Hz, Nameplate rated 50/60 Hz
03. Inrush current: Cold start @ 25°C, 40A @ 115Vac, 80A @ 230Vac
04. Efficiency: 85% to 90% typical at full load, 120-240Vac input
05. Power factor: 0.98 typical at full load, 230Vac input
06. Turn on delay: 5 Seconds maximum, (3 seconds max option)
07. Load regulation:  $\pm 1\%$  Measured at the connector side
08. Line regulation:  $\pm 0.2\%$  Measured at the connector side
09. Output Ripple protection (Peak to Peak):  $\pm 1\%$  maximum of nominal output voltage measured at 20 MHz bandwidth with 0.1 $\mu$ f ceramic capacitor in parallel with a low impedance 47  $\mu$ f electrolytic capacitor located 200mm from the end of the output connector
10. Turn on/off overshoot: 5% Maximum, 1mS recovery time
11. Hold up time: 8 mS @ 300W load, 10mS@200W load, 16mS@150W load at 115Vac input
12. Transient response: 2% Maximum deviation, returns to initial condition in 3 ms max for 25% load step, from 10% to 100% of rated load
13. Remote sense (optional): compensates for up to 0.5V voltage drop in output wiring.  
Power supply will operate correctly, with or without remote sense pins hooked up.
14. Auxillary Output: For forced air fan 12V @ 250mA, if convection cooled 12V @ 150mA. Other output voltages and current ratings from 5V to 24V available, contact factory for availability.
15. Indicator: Green LED for output presence

### B) PROTECTION

01. Input Protection: Input line fusing and 300Vac MOV
02. Short circuit: Protected. Unit will autorecover upon removal of short
03. Overload protection: Autorecover upon removal of overload
  - 150W, 175% - 210% of nominal power rating
  - 200W, 130% - 160% of nominal power rating
  - 240W, 110% - 130% of nominal power rating
  - 300W, 110% - 130% of nominal power rating
04. Over voltage: Protected at 110- 140% of nominal output voltage, latched type. AC cycling required to restore output. Autorecovery type OVP is an option, contact factory for availability.
05. Fan output protection: 3 Pin Linear Regulator, short circuit proof

### C) SAFETY

01. Dielectric Withstand Voltage: 4000Vac or 5656Vdc from input to output,  
On Class I models, 2500Vac or 3535Vdc from input to earth
02. Earth Leakage Current:
  - Class I Input Models: Does not exceed 500uA
  - Class II Input Models: Does not apply
03. Touch Current: Does not exceed 100uA, output terminations to earth
04. Output terminations rated as SELV, and Means of Operator Protection

### D) OTHER:

#### PROPRIETARY INFORMATION

PROPRIETARY OF GLOBTEK, INC. ANY REPRODUCTION, DISCLOSURE OR USE OF THIS DRAWING, IN WHOLE OR IN PART, IS HEREBY PROHIBITED EXCEPT AS SPECIFIED IN WRITING BY GLOBTEK, INC. © GlobTek, Inc. 2012 - 2023

GlobTek, Inc. www.globtek.com 186 Veterans Drive, Northvale, NJ 07647 Tel. (201) 784-1000 Fax (201) 784-0111	Drawing Title: GTM91110P24012-FA-S, Medical Power Supply, Efficiency Level: , Case Color/Style: PCB, Open Frame/Internal, Regulated Switchmode AC-DC Power Supply AC Adaptor, Input Rating: 100-240V~, 50-60 Hz, PCB Pins , Output Rating: 240W, 12.0V@20.0A, Output Configuration: N/A mm, N/A/6 Cond, , MOLEX 6-PIN FRICTION LOCK HEADER P/N 26-60-4060 MATES WITH PN: 09-50-3061, Ferrite: None, N/A, GT Cord # C1196, Pin Out: Pins 1,2,3: V+, Pins 4,5,6: Common, Blades/Input Cord: Not Applicable, Approvals: WEEE; VCCI; Ukraine; FCC; China RoHS; RoHS; EAC; Book 60601; Class I; ETL; cETLus 60950-1; cETLus 60601; SIQ; SIQ; CE; ETL;	
	Model No. GTM91110P24012-FA-S	
	Part No./Ordering No. GTM91110P24012FSIM(R)	Rev C

01. MTBF: 200,000 Hours @ 25°C ambient temperature
02. Operating Temperature Range:
  - 10°C to 50°C @ 100% output power rating
  - 10°C to 70°C @ 50% output power derating
03. Cooling:
  - Open Frame 150W Series: Convection
  - Open Frame 240W and 300W Series: 20 CFM Forced Air Cooling
  - Perforated Plastic Housing 200W Series: 20 CFM Forced Air Cooling, with convection cooling 50% derated (100W) output capability.
04. Relative Humidity: operating 0% to 90% Non-condensing
05. Storage Temperature: -30°C to 85°C
06. Altitude: up to 2000 meter
07. Random vibration/transient drop: MIL-STD 810E

E) MECHANICAL FORMAT:

150W, 240W and 300W Open Frame version

Size: 127\*76.2\*43 mm

Weight: 470 grams

200W Perforated Plastic Enclosure version

Size: 140\*87.6\*51.9 mm

Weight: 620 grams

TO ADDRESS SYSTEM-LEVEL EMI CONCERNS, FERRITE CHOKES/BEADS MAY BE ADDED/REVISED UPON REQUEST. A SAMPLE KIT OF GLOBTEK'S STANDARD FERRITES IS AVAILABLE UNDER GLOBTEK P/N: EMI-MITIGATION-KIT1

FOR ADDITIONAL INFORMATION, PLEASE READ OUR WHITE PAPER AT: <https://r.globtek.info/3QeaqtD>

<p>GlobTek, Inc.  www.globtek.com  186 Veterans Drive,  Northvale, NJ 07647  Tel. (201) 784-1000  Fax (201) 784-0111</p>	<p>Drawing Title: GTM91110P24012-FA-S, Medical Power Supply, Efficiency Level: , Case Color/Style: PCB, Open Frame/Internal, Regulated Switchmode AC-DC Power Supply AC Adaptor, Input Rating: 100-240V~, 50-60 Hz, PCB Pins , Output Rating: 240W, 12.0V@20.0A, Output Configuration: N/A mm, N/A/6 Cond, , MOLEX 6-PIN FRICTION LOCK HEADER P/N 26-60-4060 MATES WITH PN: 09-50-3061, Ferrite: None, N/A, GT Cord # C1196, Pin Out: Pins 1,2,3: V+, Pins 4,5,6: Common, Blades/Input Cord: Not Applicable, Approvals: WEEE; VCCI; Ukraine; FCC; China RoHS; RoHS; EAC; Book 60601; Class I; ETL; cETLus 60950-1; cETLus 60601; SIQ; SIQ; CE; ETL;</p>
	<p>Model No. GTM91110P24012-FA-S</p>
	<p>Part No./Ordering No. GTM91110P24012FSIM(R) <span style="float: right;">Rev C</span></p>

Mechanical drawing

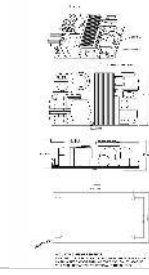

GlobTek, Inc.  
 www.globtek.com  
 186 Veterans Drive,  
 Northvale, NJ 07647  
 Tel. (201) 784-1000  
 Fax (201) 784-0111

Drawing Title: GTM91110P24012-FA-S, Medical Power Supply, Efficiency Level: , Case Color/Style: PCB, Open Frame/Internal, Regulated Switchmode AC-DC Power Supply AC Adaptor, Input Rating: 100-240V~, 50-60 Hz, PCB Pins , Output Rating: 240W, 12.0V@20.0A, Output Configuration: N/A mm, N/A/6 Cond, , MOLEX 6-PIN FRICTION LOCK HEADER P/N 26-60-4060 MATES WITH PN: 09-50-3061, Ferrite: None, N/A, GT Cord # C1196, Pin Out: Pins 1,2,3: V+, Pins 4,5,6: Common, Blades/Input Cord: Not Applicable, Approvals: WEEE; VCCI; Ukraine; FCC; China RoHS; RoHS; EAC; Book 60601; Class I; ETL; cETLus 60950-1; cETLus 60601; SIQ; SIQ; CE; ETL;

Model No. GTM91110P24012-FA-S

Part No./Ordering No. GTM91110P24012FSIM(R)

Rev C

DERATING CURVE

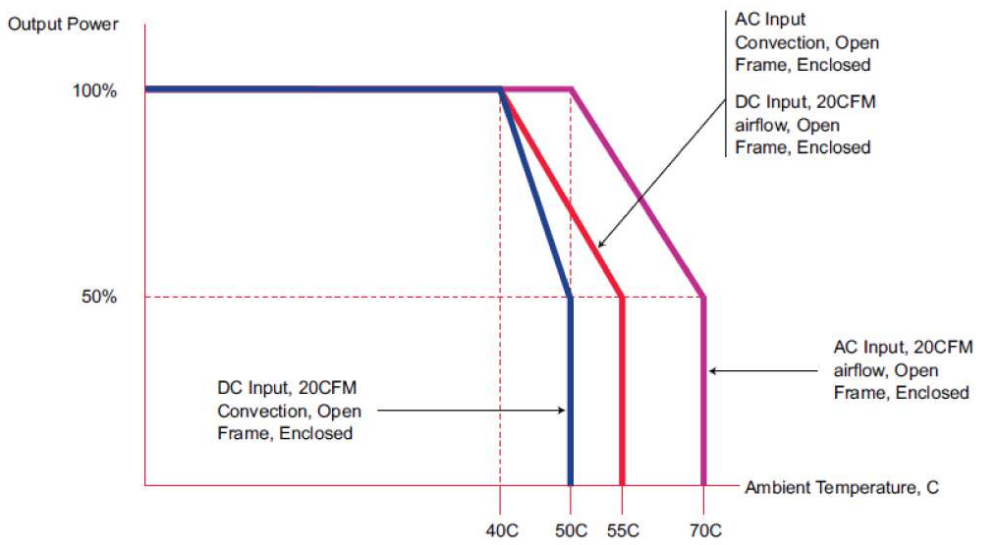

GlobTek, Inc. www.globtek.com 186 Veterans Drive, Northvale, NJ 07647 Tel. (201) 784-1000 Fax (201) 784-0111	Drawing Title: GTM91110P24012-FA-S, Medical Power Supply, Efficiency Level: , Case Color/Style: PCB, Open Frame/Internal, Regulated Switchmode AC-DC Power Supply AC Adaptor, Input Rating: 100-240V~, 50-60 Hz, PCB Pins , Output Rating: 240W, 12.0V@20.0A, Output Configuration: N/A mm, N/A/6 Cond, , MOLEX 6-PIN FRICTION LOCK HEADER P/N 26-60-4060 MATES WITH PN: 09-50-3061, Ferrite: None, N/A, GT Cord # C1196, Pin Out: Pins 1,2,3: V+, Pins 4,5,6: Common, Blades/Input Cord: Not Applicable, Approvals: WEEE; VCCI; Ukraine; FCC; China RoHS; RoHS; EAC; Book 60601; Class I; ETL; cETLus 60950-1; cETLus 60601; SIQ; SIQ; CE; ETL;	
	Model No. GTM91110P24012-FA-S	
	Part No./Ordering No. GTM91110P24012FSIM(R)	Rev C

### INPUT CONFIGURATION

(E1) Earthed output

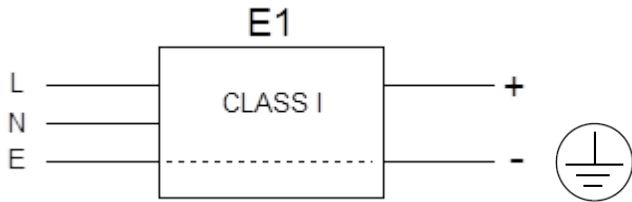

[Alternate grounding configurations](#) available upon request.

Blades/Cord Included:N/A:Not Applicable

Blades/Cord Installed:N/A:Not Applicable

Molex 26-60-4050 5 Position Header Pin 1: Gnd, Pin 2: Removed, PIN 3: Neutral, Pin 4: removed, Pin 5: Line

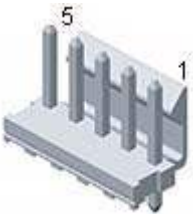

Optional Input Wiring Kits are available:

PN/Ordering No	Length	End A	End B
<a href="#">C810070M6MLX5(R)</a>	60	IEC 60320 C8 (Faston)	MOLEX 09-50-3051
<a href="#">C810070M6MLX5HW(R)</a>	60	IEC 60320 C8 (Hardwired)	MOLEX 09-50-3051
<a href="#">C1410070M6MLX5(R)</a>	60	IEC 60320 C13	MOLEX 09-50-3051
<a href="#">MLX5410070M7MLX5(R)</a>	73	MOLEX 09-50-3051	MOLEX 09-50-3051

Custom lengths, construction, cable types, ferrites, filters, and termination available upon request.



GloTek, Inc. www.globtek.com 186 Veterans Drive, Northvale, NJ 07647 Tel. (201) 784-1000 Fax (201) 784-0111	Drawing Title: GTM91110P24012-FA-S, Medical Power Supply, Efficiency Level: , Case Color/Style: PCB, Open Frame/Internal, Regulated Switchmode AC-DC Power Supply AC Adaptor, Input Rating: 100-240V~, 50-60 Hz, PCB Pins , Output Rating: 240W, 12.0V@20.0A, Output Configuration: N/A mm, N/A/6 Cond, , MOLEX 6-PIN FRICTION LOCK HEADER P/N 26-60-4060 MATES WITH PN: 09-50-3061, Ferrite: None, N/A, GT Cord # C1196, Pin Out: Pins 1,2,3: V+, Pins 4,5,6: Common, Blades/Input Cord: Not Applicable, Approvals: WEEE; VCCI; Ukraine; FCC; China RoHS; RoHS; EAC; Book 60601; Class I; ETL; cETLus 60950-1; cETLus 60601; SIQ; SIQ; CE; ETL;	
	Model No. GTM91110P24012-FA-S	
	Part No./Ordering No. GTM91110P24012FSIM(R)	Rev C

**OUTPUT CORD AND CONNECTOR: MOLFC1196**

ACTUAL CONNECTORS, OVERMOLDS, FERRITES MAY VARY SLIGHTLY FROM THE PICTURE BELOW

**CABLE TYPE**

CABLE LENGTH (mm)	N/A
CABLE TOLERANCE (mm)	N/A
WIRE GAUGE (AWG)	N/A
CONDUCTORS	6
HANK DIMENSION (mm)	N/A
CABLE / CONNECTOR OVERMOLD COLOR	N/A
FERRITE TYPE AND DIMENSION	None
FERRITE NUMBER OF TURNS <a href="#">(Definition)</a>	N/A
FERRITE DIMENSION FROM STRAIN RELIEF	N/A
FERRITE DIMENSION FROM PLUG	N/A
PLUG TYPE	MOLEX 6-PIN FRICTION LOCK HEADER P/N 26-60-4060 MATES WITH PN: 09-50-3061
CONNECTOR PIN OUT	Pins 1,2,3: V+, Pins 4,5,6: Common

Drawing: [http://www.molex.com/pdm\\_docs/sd/022280040\\_sd.pdf](http://www.molex.com/pdm_docs/sd/022280040_sd.pdf)

Datasheet: [http://www.molex.com/molex/products/datasheet.jsp?part=active/0022280040\\_PCB\\_HEADERS.xml](http://www.molex.com/molex/products/datasheet.jsp?part=active/0022280040_PCB_HEADERS.xml)

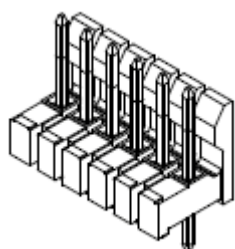

**[Mates With Part\(s\):](#)**

[KK® Crimp Housing 2695, 6471, 7880](#), [KK® PC Board Connector 4455](#)

ADDITIONAL OUTPUT PLUG OPTIONS ARE AVAILABLE AT <https://www.globtek.com/connectors/>

STANDARD PLUGS AND CONNECTORS CAN BE SEEN ONLINE AT <https://www.globtek.com/connectors/>

CALCULATE VOLTAGE REGULATION/DROP WITH OUR ONLINE CALCULATOR: <https://en.globtek.com/output-cable-regulation-calculator/>

<p>GlobTek, Inc.  www.globtek.com  186 Veterans Drive,  Northvale, NJ 07647  Tel. (201) 784-1000  Fax (201) 784-0111</p>	<p>Drawing Title: GTM91110P24012-FA-S, Medical Power Supply, Efficiency Level: , Case Color/Style: PCB, Open Frame/Internal, Regulated Switchmode AC-DC Power Supply AC Adaptor, Input Rating: 100-240V~, 50-60 Hz, PCB Pins , Output Rating: 240W, 12.0V@20.0A, Output Configuration: N/A mm, N/A/6 Cond, , MOLEX 6-PIN FRICTION LOCK HEADER P/N 26-60-4060 MATES WITH PN: 09-50-3061, Ferrite: None, N/A, GT Cord # C1196, Pin Out: Pins 1,2,3: V+, Pins 4,5,6: Common, Blades/Input Cord: Not Applicable, Approvals: WEEE; VCCI; Ukraine; FCC; China RoHS; RoHS; EAC; Book 60601; Class I; ETL; cETLus 60950-1; cETLus 60601; SIQ; SIQ; CE; ETL;</p>
	<p>Model No. GTM91110P24012-FA-S</p>
	<p>Part No./Ordering No. GTM91110P24012FSIM(R) <span style="float: right;">Rev C</span></p>

## OUTPUT CONNECTOR HOOK UP

TO ADDRESS SYSTEM-LEVEL EMI CONCERNS, FERRITE CHOKES/BEADS MAY BE ADDED/REVISED UPON REQUEST. A SAMPLE KIT OF GLOBTEK'S STANDARD FERRITES IS AVAILABLE UNDER GLOBTEK P/N: EMI-MITIGATION-KIT1

FOR ADDITIONAL INFORMATION, PLEASE READ OUR WHITE PAPER AT:

<https://en.globtek.com/technical-articles/ferrite-kit-radiated-emi-suppression-kit-for-globtek-power-supplies-cable-assemblies>

GlobTek, Inc. www.globtek.com 186 Veterans Drive, Northvale, NJ 07647 Tel. (201) 784-1000 Fax (201) 784-0111	Drawing Title: GTM91110P24012-FA-S, Medical Power Supply, Efficiency Level: , Case Color/Style: PCB, Open Frame/Internal, Regulated Switchmode AC-DC Power Supply AC Adaptor, Input Rating: 100-240V~, 50-60 Hz, PCB Pins , Output Rating: 240W, 12.0V@20.0A, Output Configuration: N/A mm, N/A/6 Cond, , MOLEX 6-PIN FRICTION LOCK HEADER P/N 26-60-4060 MATES WITH PN: 09-50-3061, Ferrite: None, N/A, GT Cord # C1196, Pin Out: Pins 1,2,3: V+, Pins 4,5,6: Common, Blades/Input Cord: Not Applicable, Approvals: WEEE; VCCI; Ukraine; FCC; China RoHS; RoHS; EAC; Book 60601; Class I; ETL; cETLus 60950-1; cETLus 60601; SIQ; SIQ; CE; ETL;	
	Model No. GTM91110P24012-FA-S	
	Part No./Ordering No. GTM91110P24012FSIM(R)	Rev C

**LABEL:L-1186**

LABEL P/N	Standard GT
MATERIAL	Flat Thermal Transfer, Imprintable, Polyester Label and/or Pad Printed and/or Molded, and/or Laser Engraved in the case
BACKGROUND COLOR	Black if housing is Black, White or Silver if housing is White or Gray.
TEXT COLOR	White or Silver if label is Black Background for Black housing. Black if label is White or Silver background and Housing is White or Gray.
LABEL WIDTH (mm)	30.0
LABEL HEIGHT (mm)	20.0
SPECIAL BARCODE LABEL MATERIAL	No

Below is the minimum information which will appear on the label. NOTE: in the logo area additional/actual positioning of symbols and text is subjected to change as per agency updates/requirements or additional model approvals become available.  
 Regulatory certifications/label markings may be in logo area on the label or molded into the case housing outside the label area.  
 Information will be shown via label and/or pad printed and/or molded and/or laser engraved in the case. \* Date code markings at GlobTek option



or  
**DATE CODE B \*:**  
 WWYY  
 WW = WEEK  
 YY = YEAR

- A=Medical Power Supply
- B=P/N: (料号) GTM91110P24012FSIM(R)
- C=Model (型号) GTM91110P24012-FA-S
- D=Input (输入)100-240V~, 50-60 Hz, 4.0
- E=Output (输出)12.0 V 20.0 A, 240.00W

<b>GlobTek, Inc.</b> www.globtek.com 186 Veterans Drive, Northvale, NJ 07647 Tel. (201) 784-1000 Fax (201) 784-0111	Drawing Title: GTM91110P24012-FA-S, Medical Power Supply, Efficiency Level: , Case Color/Style: PCB, Open Frame/Internal, Regulated Switchmode AC-DC Power Supply AC Adaptor, Input Rating: 100-240V~, 50-60 Hz, PCB Pins , Output Rating: 240W, 12.0V@20.0A, Output Configuration: N/A mm, N/A/6 Cond, , MOLEX 6-PIN FRICTION LOCK HEADER P/N 26-60-4060 MATES WITH PN: 09-50-3061, Ferrite: None, N/A, GT Cord # C1196, Pin Out: Pins 1,2,3: V+, Pins 4,5,6: Common, Blades/Input Cord: Not Applicable, Approvals: WEEE; VCCI; Ukraine; FCC; China RoHS; RoHS; EAC; Book 60601; Class I; ETL; cETLus 60950-1; cETLus 60601; SIQ; SIQ; CE; ETL;	
	Model No. GTM91110P24012-FA-S	
	Part No./Ordering No. GTM91110P24012FSIM(R)	Rev C

AGENCY ONLINE DOCUMENTS	<a href="http://www.globtek.info/certs/GTM91110P/">http://www.globtek.info/certs/GTM91110P/</a>
CE EC-Declaration for Medical	<a href="#">Contact GlobTek for more information</a>
CE EC-Declaration for Industrial/Commercial/ITE	<a href="http://globtek.force.com/models/ec_declaration_product?id=01t30000002p7QK&amp;i=4">http://globtek.force.com/models/ec_declaration_product?id=01t30000002p7QK&amp;i=4</a>
CE EC-Declaration for Household	<a href="#">Contact GlobTek for more information</a>
UKCA-Declaration for Medical	<a href="#">Contact GlobTek for more information</a>
UKCA-Declaration for Industrial/Commercial/ITE	<a href="http://globtek.force.com/models/ukca_declaration_product?id=01t30000002p7QK&amp;i=4">http://globtek.force.com/models/ukca_declaration_product?id=01t30000002p7QK&amp;i=4</a>
UKCA-Declaration for Household	<a href="#">Contact GlobTek for more information</a>
Morocco SDoC Declaration	<a href="https://globtek.secure.force.com/models/Morocco_SDoC_Declaration?id=a0Oa000000Bz790EAB">https://globtek.secure.force.com/models/Morocco_SDoC_Declaration?id=a0Oa000000Bz790EAB</a>
RoHS/RoHS3 Declaration	<a href="https://www.globtek.com/pdf/rohs_cert/01t30000002p7QKAAAY">https://www.globtek.com/pdf/rohs_cert/01t30000002p7QKAAAY</a>
REACH Declaration	<a href="https://www.globtek.com/pdf/iso_certificates/REACH.pdf">https://www.globtek.com/pdf/iso_certificates/REACH.pdf</a>
Conflict Minerals Declaration	<a href="https://www.globtek.com/pdf/conflict-minerals.pdf">https://www.globtek.com/pdf/conflict-minerals.pdf</a>
Prop 65 Statement	<a href="https://en.globtek.com/prop-65-statement.pdf">https://en.globtek.com/prop-65-statement.pdf</a>
IPXY rating is based on 3rd party testing and customers should check suitability and test system level IPXY rating before ordering.	

## Regulatory Certifications/Label Markings

Below follows a link to the latest regulatory certifications and marks for this specific product. National standards as well as certification schemes are constantly changing and so is the set of certification marks and symbols applicable to this product. Various standards, marks and symbols, and certificates are subject to change at any time without notice.

Additional standards or unique country certifications are available upon request. Please contact Globtek to request a quotation.

LATEST PRODUCT/MODEL CERTIFICATIONS:	<a href="https://www.globtek.com/datasheet/w70641">https://www.globtek.com/datasheet/w70641</a>
AGENCY ONLINE DOCUMENTS	<a href="http://www.globtek.info/certs/GTM91110P/">http://www.globtek.info/certs/GTM91110P/</a>



(E1) Earthed output

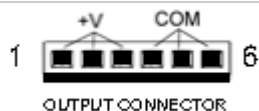

Pins 1,2,3: V+, Pins 4,5,6: Common

GloTek, Inc. www.globtek.com 186 Veterans Drive, Northvale, NJ 07647 Tel. (201) 784-1000 Fax (201) 784-0111	Drawing Title: GTM91110P24012-FA-S, Medical Power Supply, Efficiency Level: , Case Color/Style: PCB, Open Frame/Internal, Regulated Switchmode AC-DC Power Supply AC Adaptor, Input Rating: 100-240V~, 50-60 Hz, PCB Pins , Output Rating: 240W, 12.0V@20.0A, Output Configuration: N/A mm, N/A/6 Cond, , MOLEX 6-PIN FRICTION LOCK HEADER P/N 26-60-4060 MATES WITH PN: 09-50-3061, Ferrite: None, N/A, GT Cord # C1196, Pin Out: Pins 1,2,3: V+, Pins 4,5,6: Common, Blades/Input Cord: Not Applicable, Approvals: WEEE; VCCI; Ukraine; FCC; China RoHS; RoHS; EAC; Book 60601; Class I; ETL; cETLus 60950-1; cETLus 60601; SIQ; SIQ; CE; ETL;	
	Model No. GTM91110P24012-FA-S	
	Part No./Ordering No. GTM91110P24012FSIM(R)	Rev C

## PACKAGING

Packing Spec P/N	Standard OF, Individually Box
Box Qty	60
Gift Box Size (mm)	135 x 85 x 60
Gift Box Color	White
Master Carton Size (mm)	430 x 380 x 275
Master Carton Cubic Volume (m <sup>3</sup> )	0.04
Master GW (Kg)	kg
BLADES INCLUDED	N/A: Not Applicable
BLADE/CORD INSTALLED	N/A: Not Applicable
USER MANUAL*	N/A User Manual
USER MANUAL WEB LINK	

\* This specification sheet is considered the user manual for all applications. It is expected that the buyer of this product will use it to formulate their own user manual for their end product and a user manual specifically for the power adapter is not usually required. If a user manual is not specifically listed above then none will be provided with this unit.

If specific packaging is required, this section must specify all requirements and note "no exceptions". If this section does not specify packaging, it is subject to change without notice at GlobTek's discretion  
(Power Supply in picture for reference only)

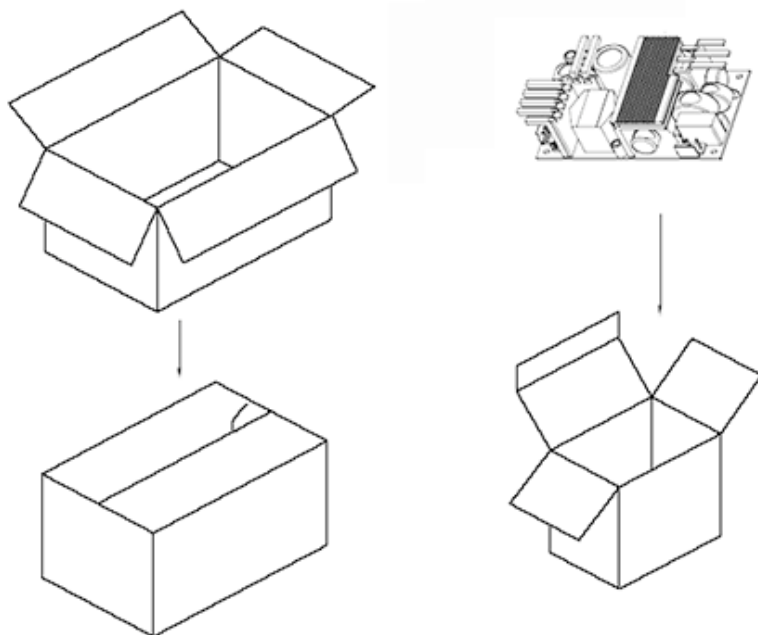

### PROPRIETARY INFORMATION

GlobTek, Inc. www.globtek.com 186 Veterans Drive, Northvale, NJ 07647 Tel. (201) 784-1000 Fax (201) 784-0111	Drawing Title: GTM91110P24012-FA-S, Medical Power Supply, Efficiency Level: , Case Color/Style: PCB, Open Frame/Internal, Regulated Switchmode AC-DC Power Supply AC Adaptor, Input Rating: 100-240V~, 50-60 Hz, PCB Pins , Output Rating: 240W, 12.0V@20.0A, Output Configuration: N/A mm, N/A/6 Cond, , MOLEX 6-PIN FRICTION LOCK HEADER P/N 26-60-4060 MATES WITH PN: 09-50-3061, Ferrite: None, N/A, GT Cord # C1196, Pin Out: Pins 1,2,3: V+, Pins 4,5,6: Common, Blades/Input Cord: Not Applicable, Approvals: WEEE; VCCI; Ukraine; FCC; China RoHS; RoHS; EAC; Book 60601; Class I; ETL; cETLus 60950-1; cETLus 60601; SIQ; SIQ; CE; ETL;	
	Model No. GTM91110P24012-FA-S	
	Part No./Ordering No. GTM91110P24012FSIM(R)	Rev C

## INSTRUCTIONS TO THE OEM SYSTEMS ENGINEER

It is the responsibility of the OEM systems engineer to provide the end system user instructions and warnings for the use of this product in the end system.

If an input cord is required for this product, AC Mains voltage should be provided to the power supply by a power supply cord approved to the national standards of the country in which it will be used.

This product is not designed to be repaired. No serviceable parts inside. A blown internal fuse is an indication of catastrophic failure of circuit component(s). If a Failure Analysis is required for a failed power supply/battery charger, please return the damaged unit to GlobTek for an accurate determination of the root cause of the failure.

EMC Compliance of the complete OEM product, including the GlobTek power supply/battery charger needs to be verified by the OEM systems engineer.

## INSTRUCTION SHEET

---

<p>GlobTek, Inc.  www.globtek.com  186 Veterans Drive,  Northvale, NJ 07647  Tel. (201) 784-1000  Fax (201) 784-0111</p>	<p>Drawing Title: GTM91110P24012-FA-S, Medical Power Supply, Efficiency Level: , Case Color/Style: PCB, Open Frame/Internal, Regulated Switchmode AC-DC Power Supply AC Adaptor, Input Rating: 100-240V~, 50-60 Hz, PCB Pins , Output Rating: 240W, 12.0V@20.0A, Output Configuration: N/A mm, N/A/6 Cond, , MOLEX 6-PIN FRICTION LOCK HEADER P/N 26-60-4060 MATES WITH PN: 09-50-3061, Ferrite: None, N/A, GT Cord # C1196, Pin Out: Pins 1,2,3: V+, Pins 4,5,6: Common, Blades/Input Cord: Not Applicable, Approvals: WEEE; VCCI; Ukraine; FCC; China RoHS; RoHS; EAC; Book 60601; Class I; ETL; cETLus 60950-1; cETLus 60601; SIQ; SIQ; CE; ETL;</p>
	<p>Model No. GTM91110P24012-FA-S</p>
	<p>Part No./Ordering No. GTM91110P24012FSIM(R) <span style="float: right;">Rev C</span></p>

