

User's Guide

BQ25170EVM Evaluation Module



Bill Johns

ABSTRACT

This user's guide describes the characteristics, operation, and use of the BQ25170EVM evaluation module (EVM). This EVM is designed to help the user evaluate and test the various operating modes of the BQ25170. This user's guide includes setup instructions for the hardware and software, a schematic diagram, a bill of materials (BOM), and PCB layout drawings for the evaluation module.

Throughout this user's guide, the abbreviations *EVM*, *BQ25170EVM*, *BMS033*, and the term *evaluation module* are synonymous with the BMS033 evaluation module, unless otherwise noted.

Table of Contents

1 Introduction	2
1.1 Printed Circuit Board Assembly.....	2
1.2 I/O Descriptions.....	2
2 Test Summary	3
2.1 Equipment.....	3
2.2 Cautions.....	3
2.3 Test Instructions.....	3
3 Board Layout, Schematic, and Bill of Materials	4
3.1 Board Layout.....	4
3.2 Schematic.....	7
3.3 Bill of Materials.....	8
4 Revision History	12

Trademarks

All trademarks are the property of their respective owners.



WARNING

Hot surface! Contact may cause burns. Do not touch!

Some components may reach high temperatures >55°C when the board is powered on. The user must not touch the board at any point during operation or immediately after operating, as high temperatures may be present.

1 Introduction

The Texas Instruments BQ25170EVM is a Li-Ion, Li-Poly and LiFePO₄ chemistry battery charger IC for single cell. Charging voltage can be adjusted using external resistors on VSET. Charging current can be set from 60mA to 600mA with external resistor on ISET.

1.1 Printed Circuit Board Assembly

The BQ25170EVM PCB contains the BQ25170 IC, LDO TPS7B8133 and support circuits. This board contains several jumpers and connectors. S1 (VSET) allows selected output voltages to be programmed. R9 resistor allows a wide range of adjustment of VSET. R22 can be used to change ISET value, fast charge current. R19 can be used to adjust TS, battery temp sensor to simulate hot and cold fault.

1.2 I/O Descriptions

Table 1-1 lists the input and output connections available on this EVM and their respective descriptions.

Table 1-1. EVM I/O Connections

I/O Connector	Description
J1 – VIN / GND	Input voltage from external power supply, recommended 5V. Max operating input voltage is 6.6V, OVP trip point. Max input voltage is 30V while in OVP.
J2 – OUT (BAT+) / GND (BAT-) / GND / TS	Battery connection, TS should be 10k NTC but not needed.
JP1 – VSET ADJ.	Disable R9, default is installed.
JP2 – REG / IN / OUT	Source voltage for housekeeping regulator, U2. Default Input voltage IN.
JP3 – PG (Power Good) LED	Default setting is ON.
JP4 – ISET	Sets Fast Charge Current. Fixed=400mA ADJ= R22 range 60mA to 600mA
JP5 - STAT LED	Default setting is ON.
JP6 – TS	NTC temp sensor. Fixed=10k (safe) ADJ=R19 range from 0 to 50k ohms. Default Fixed.
JP7	Not used, do not install
JP8	Not used, do not install
JP9	Not used, do not install

Table 1-2 lists the S1 switch positions for VSET and their respective descriptions. Use only one position ON, do not combine.

Table 1-2. VSET S1 Switch Positions

Position / RX / Value	Li+Voltage / Configuration
#1 / R1 / 100k ohm	3.5V / 1-Cell LiFePO ₄
#2 / R2 / 82k ohm	3.6V / 1-Cell LiFePO ₄
#3 / R3 / 62k ohm	3.7V / 1-Cell LiFePO ₄
#4 / R4 / 36k ohm	4.1V / 1-Cell Li-Ion
#5 / R5 / 27k ohm	4.2V / 1-Cell Li-Ion
#6 / R6 / 24k ohm	4.35V / 1-Cell Li-Ion
#7 / R7 / 18k ohm	4.4V / 1-Cell Li-Ion
#8 / R8 / 0 ohm	Short Circuit – No Charge

2 Test Summary

This section describes the jumpers and connectors on the EVM as well as how to properly connect, setup, and use the BQ25170EVM. Note that the default jumper setting of headers and switches are marked with two dots to indicate the shorting jumper position. This will put the unit into a single cell Li-Ion configuration, 4.2V at 400mA.

2.1 Equipment

This section includes a list of supplies required to perform tests on this EVM.

1. Battery simulator such as Keithley 2400 or equivalent. Or a single-cell battery.
2. Power supply, 5V 1A input. Note that unit can operate up to 6.6V input.
3. Voltage meter and current meter.

2.2 Cautions

To prevent possible damage to battery under test verify that charging conditions of the cell are not exceeded. Check max charge voltage and current.

Power dissipation of the device can be exceeded with too high an input to output voltage drop and current. Thermal regulation begins reducing current at 125 °C, at 150 °C device will shut off.

Device can get hot during high input-to-output voltage drop and high current conditions. Use caution when handling the board.

2.3 Test Instructions

In order for this EVM to operate properly, the following components must be connected and properly configured.

1. Set input power supply to 5V and Battery Simulator to 3.6V with compliance to support 800mA. Turn off Supply and Battery Simulator.
2. Connect input voltages to J1 and Battery Simulator to J2 on the EVM.
3. Configure all EVM jumpers to factory setting, refer to table below.
4. Turn on all supplies and loads
 - a. 5V Input supply current limit should be greater than 500mA
 - b. Out voltage should be 3.6V and charge current 400mA
 - c. LED D1 and D2 will be ON
5. Simulate battery completing charge by increasing Battery Simulator voltage to 4.2V
 - a. Current will decrease to 0mA
 - b. LED D2 will switch to OFF.

Table 2-1. Jumper Factory Setting

I/O Connector	Factory Setting
JP1	Installed
JP2	IN
JP3	Installed
JP4	Fixed
JP5	Installed
JP6	Fixed
JP7	N/A
JP8	N/A
JP9	N/A
S1	Position 3 (4.2 V Li-Ion)
S2	N/A

Note: IN, ON, Fixed are positions of a 3 pin header. If it is a 2 pin header then it is installed or not installed.

3 Board Layout, Schematic, and Bill of Materials

3.1 Board Layout

The board layout is shown in [Figure 3-1](#) to [Figure 3-6](#).

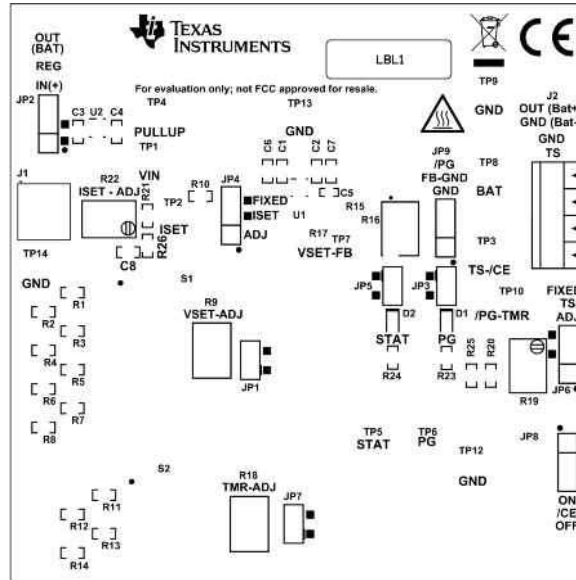

Figure 3-1. Top Overlay

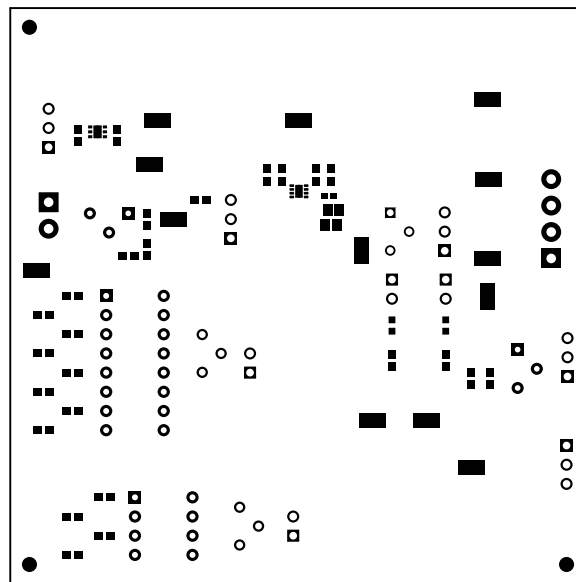

Figure 3-2. Top Solder

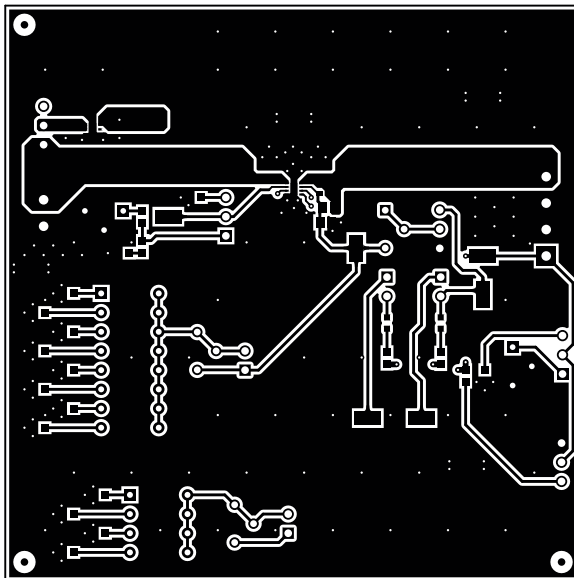

Figure 3-3. Top Layer

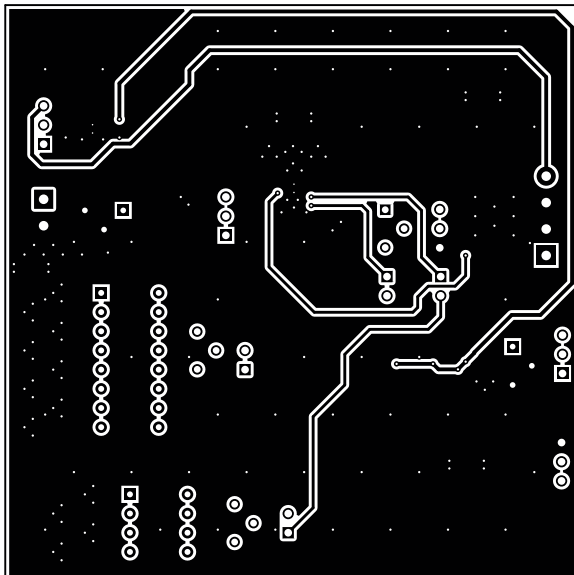

Figure 3-4. Bottom Layer

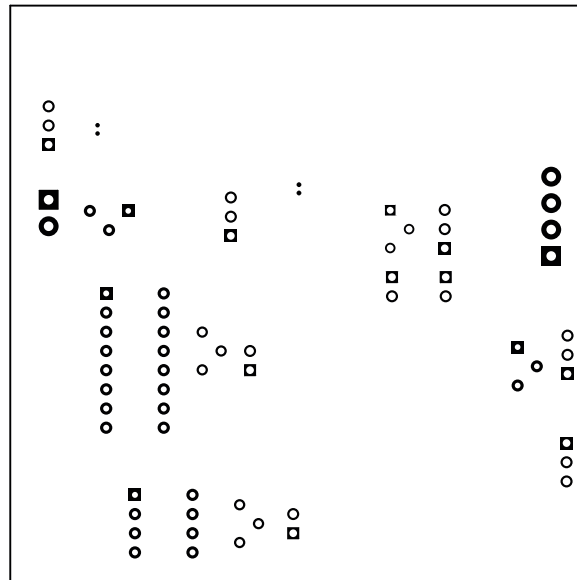

Figure 3-5. Bottom Solder

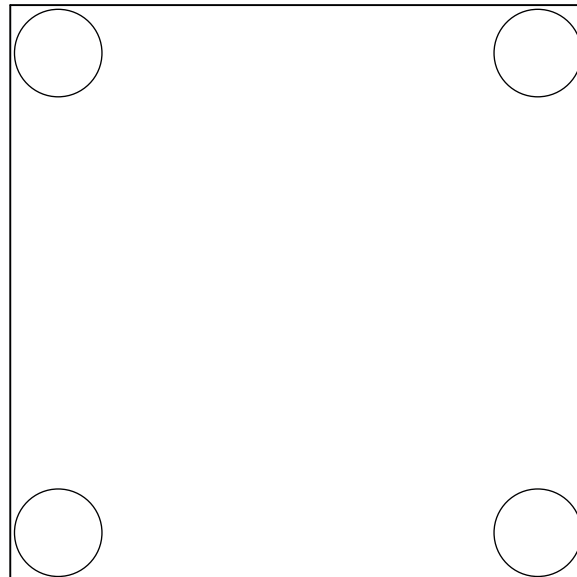

Figure 3-6. Bottom Overlay

3.2 Schematic

The BQ25170EVM schematic is shown in Figure 3-7.

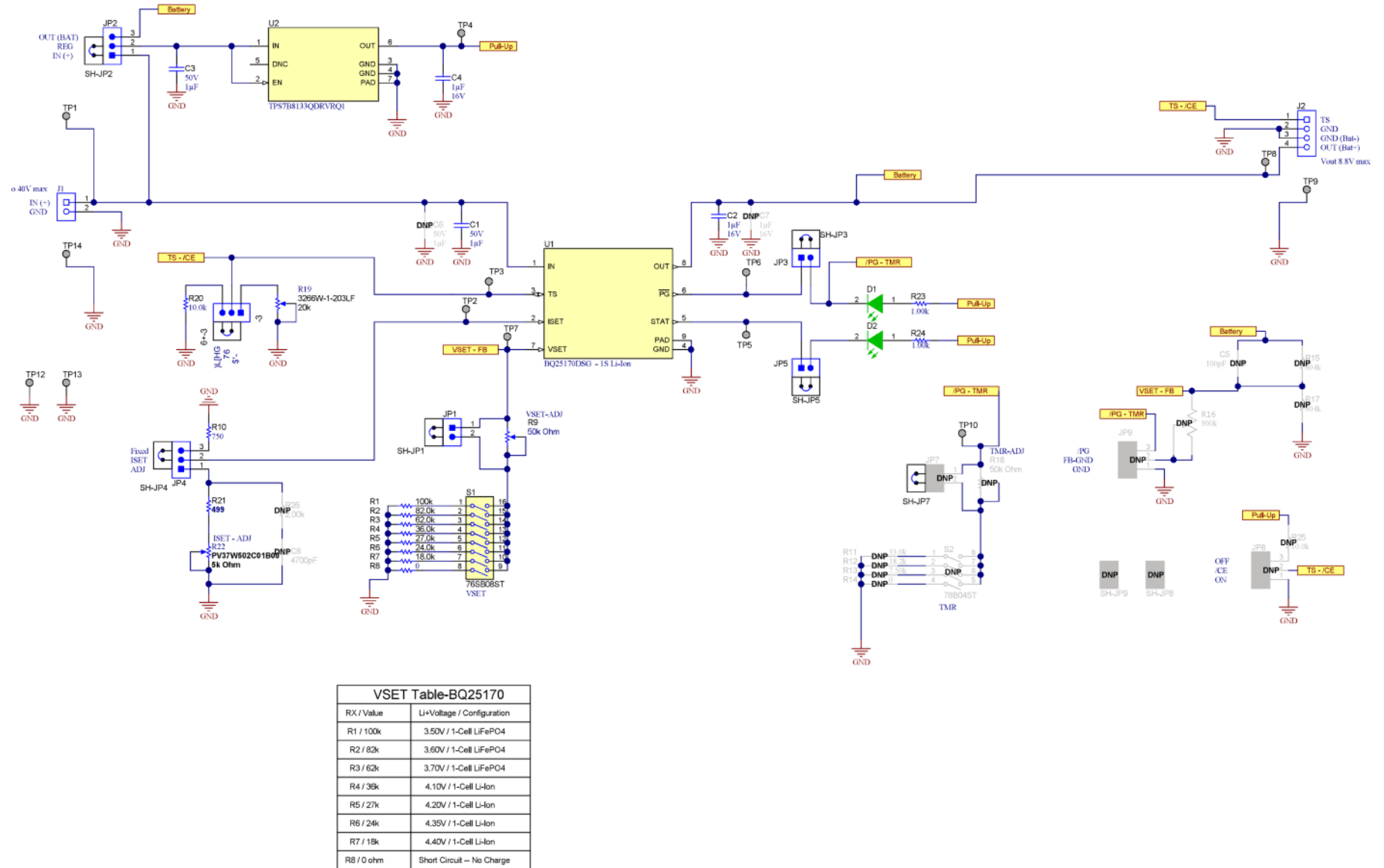

Figure 3-7. BQ25170EVM Schematic

3.3 Bill of Materials

The bill of materials is shown in the following table.

Table 3-1. Bill of Materials

Designator	Quantity	Value	Description	PackageReference	PartNumber	Manufacturer	Alternate PartNumber	Alternate Manufacturer
!PCB?	1		Printed Circuit Board		BMS033	Any		
C1, C3	2	1uF	CAP, CERM, 1 μ F, 50 V, +/- 20%, X5R, AEC-Q200 Grade 3, 0603	0603	GRT188R61H105ME13D	MuRata		
C2, C4	2	1uF	CAP, CERM, 1 μ F, 16 V, +/- 10%, X7R, AEC-Q200 Grade 1, 0603	0603	GCM188R71C105KA64D	MuRata		
D1, D2	2	Green	LED, Green, SMD	Body1.6x0.8mm	LTST-C193TGKT-5A	Lite-On		
H1, H2, H3, H4	4		Bumpon, Hemisphere, 0.44 X 0.20, Clear	Transparent Bumpon	SJ-5303 (CLEAR)	3M		
J1	1		Terminal Block, 3.5mm Pitch, 2x1, TH	7.0x8.2x6.5mm	ED555/2DS	On-Shore Technology		
J2	1		Terminal Block, 3.5mm Pitch, 4x1, TH	14x8.2x6.5mm	ED555/4DS	On-Shore Technology		
JP1, JP3, JP5	3		Header, 100mil, 2x1, Tin, TH	Header, 2 PIN, 100mil, Tin	PEC02SAAN	Sullins Connector Solutions		
JP2, JP4, JP6	3		Header, 100mil, 3x1, Tin, TH	Header, 3 PIN, 100mil, Tin	PEC03SAAN	Sullins Connector Solutions		
LBL1	1		Thermal Transfer Printable Labels, 0.650" W x 0.200" H - 10,000 per roll	PCB Label 0.650 x 0.200 inch	THT-14-423-10	Brady		
R1	1	100k	RES, 100 k, 1%, 0.1 W, 0603	0603	RC0603FR-07100KL	Yageo		
R2	1	82.0k	RES, 82.0 k, 1%, 0.1 W, 0603	0603	RC0603FR-0782KL	Yageo		
R3	1	62.0k	RES, 62.0 k, 1%, 0.1 W, 0603	0603	RC0603FR-0762KL	Yageo		
R4	1	36.0k	RES, 36.0 k, 1%, 0.1 W, 0603	0603	RC0603FR-0736KL	Yageo		
R5	1	27.0k	RES, 27.0 k, 1%, 0.1 W, 0603	0603	RC0603FR-0727KL	Yageo		
R6	1	24.0k	RES, 24.0 k, 1%, 0.1 W, 0603	0603	RC0603FR-0724KL	Yageo		

Table 3-1. Bill of Materials (continued)

Designator	Quantity	Value	Description	PackageReference	PartNumber	Manufacturer	Alternate PartNumber	Alternate Manufacturer
R7	1	18.0k	RES, 18.0 k, 1%, 0.1 W, 0603	0603	RC0603FR-0718KL	Yageo		
R8	1	0	RES, 0, 5%, 0.1 W, 0603	0603	RC0603JR-070RL	Yageo		
R9	1	50k Ohm	Trimmer Potentiometer, Lead Sealed Type Multiturn PV37 Series, TH	6.71x4.5mm	PV37W503C01B00	Bourns		
R10	1	750	RES, 750, 1%, 0.1 W, 0603	0603	RC0603FR-07750RL	Yageo		
R19	1	20k	Trimmer, 20k ohm, 0.25W, TH	4.5x8x6.7mm	3266W-1-203LF	Bourns		
R20	1	10.0k	RES, 10.0 k, 1%, 0.1 W, AEC-Q200 Grade 0, 0603	0603	CRCW060310K0FKEA	Vishay-Dale		
R21	1	499	RES, 499, 1%, 0.1 W, 0603	0603	CRCW0603499RFKEAC	Vishay-Dale		
R22	1	5k Ohm	Trimmer Potentiometer, Lead Sealed Type Multiturn PV37 Series, TH	6.71x4.5mm	PV37W502C01B00	Bourns		
R23, R24	2	1.00k	RES, 1.00 k, 1%, 0.1 W, 0603	0603	RC0603FR-071KL	Yageo		
S1	1		Switch, SPST 8Pos, Rocker, TH	9.65X8X22.4mm	76SB08ST	Grayhill		
SH-JP1, SH-JP2, SH-JP3, SH-JP4, SH-JP5, SH-JP6, SH-JP7	7	1x2	Shunt, 100mil, Gold plated, Black	Shunt	SNT-100-BK-G	Samtec	969102-0000-DA	3M
TP1, TP2, TP3, TP4, TP5, TP6, TP7, TP8, TP9, TP10, TP12, TP13, TP14	13		Test Lead clips and hooks, SMT	Test Point, Body 3.25x1.65mm	S1751-46	Harwin		
U1	1		BQ25170DSG, DSG0008A (WSON-8)	DSG0008A	BQ25170DSG - 1S Li-Ion	Texas Instruments		Texas Instruments

Table 3-1. Bill of Materials (continued)

Designator	Quantity	Value	Description	PackageReference	PartNumber	Manufacturer	Alternate PartNumber	Alternate Manufacturer
U2	1		Automotive 150-mA high-voltage ultra-low-IQ low-dropout (LDO) linear regulator, DRV0006A (WSON-6)	DRV0006A	TPS7B8133QDRVRQ1	Texas Instruments		Texas Instruments
C5	0	100pF	CAP, CERM, 100 pF, 50 V, +/- 1%, C0G/NP0, 0402	0402	04025A101FAT2A	AVX		
C6	0	1uF	CAP, CERM, 1 uF, 50 V, +/- 20%, X5R, AEC-Q200 Grade 3, 0603	0603	GRT188R61H105ME13D	MuRata		
C7	0	1uF	CAP, CERM, 1 uF, 16 V, +/- 10%, X7R, AEC-Q200 Grade 1, 0603	0603	GCM188R71C105KA64D	MuRata		
C8	0	4700pF	CAP, CERM, 4700 pF, 50 V, +/- 10%, X5R, 0603	0603	GRM188R61H472KA01D	MuRata		
FID1, FID2, FID3	0		Fiducial mark. There is nothing to buy or mount.	N/A	N/A	N/A		
JP7	0		Header, 100mil, 2x1, Tin, TH	Header, 2 PIN, 100mil, Tin	PEC02SAAN	Sullins Connector Solutions		
JP8, JP9	0		Header, 100mil, 3x1, Tin, TH	Header, 3 PIN, 100mil, Tin	PEC03SAAN	Sullins Connector Solutions		
R11	0	33.0k	RES, 33.0 k, 1%, 0.1 W, 0603	0603	RC0603FR-0733KL	Yageo		
R12	0	18.2k	RES, 18.2 k, 1%, 0.1 W, 0603	0603	RC0603FR-0718K2L	Yageo		
R13	0	7.50k	RES, 7.50 k, 1%, 0.1 W, 0603	0603	RC0603FR-077K5L	Yageo		
R14	0	0	RES, 0, 5%, 0.1 W, 0603	0603	RC0603JR-070RL	Yageo		
R15, R17	0	604k	RES, 604 k, 0.1%, 0.125 W, 0805	0805	RT0805BRD07604KL	Yageo America		

Table 3-1. Bill of Materials (continued)

Designator	Quantity	Value	Description	PackageReference	PartNumber	Manufacturer	Alternate PartNumber	Alternate Manufacturer
R16	0		500 kOhms 0.25W, 1/4W PC Pins Through Hole Trimmer Potentiometer Cermet 12 Turn Top Adjustment	PTH_3	PV37W504C01B00	Bourns		
R18	0	50k Ohm	Trimmer Potentiometer, Lead Sealed Type Multiturn PV37 Series, TH	6.71x4.5mm	PV37W503C01B00	Bourns		
R25	0	10.0k	RES, 10.0 k, 1%, 0.1 W, AEC-Q200 Grade 0, 0603	0603	CRCW060310K0FKEA	Vishay-Dale		
R26	0	2.00k	RES, 2.00 k, 1%, 0.1 W, AEC-Q200 Grade 0, 0603	0603	CRCW06032K00FKEA	Vishay-Dale		
S2	0		DIP Switch, SPST 4Pos, Slide, TH	DIP Switch, 4 Pos	78B04ST	Grayhill		
SH-JP8, SH- JP9	0	1x2	Shunt, 100mil, Gold plated, Black	Shunt	SNT-100-BK-G	Samtec	969102-0000-DA	3M

Unless otherwise noted in the Alternate PartNumber and/or Alternate Manufacturer columns, all parts may be substituted with equivalents.

4 Revision History

NOTE: Page numbers for previous revisions may differ from page numbers in the current version.

Changes from Revision * (August 2020) to Revision A (June 2021)	Page
• Changed Figure 3-1	4
• Changed Figure 3-7	7
• Changed Table 3-1	8

IMPORTANT NOTICE AND DISCLAIMER

TI PROVIDES TECHNICAL AND RELIABILITY DATA (INCLUDING DATA SHEETS), DESIGN RESOURCES (INCLUDING REFERENCE DESIGNS), APPLICATION OR OTHER DESIGN ADVICE, WEB TOOLS, SAFETY INFORMATION, AND OTHER RESOURCES "AS IS" AND WITH ALL FAULTS, AND DISCLAIMS ALL WARRANTIES, EXPRESS AND IMPLIED, INCLUDING WITHOUT LIMITATION ANY IMPLIED WARRANTIES OF MERCHANTABILITY, FITNESS FOR A PARTICULAR PURPOSE OR NON-INFRINGEMENT OF THIRD PARTY INTELLECTUAL PROPERTY RIGHTS.

These resources are intended for skilled developers designing with TI products. You are solely responsible for (1) selecting the appropriate TI products for your application, (2) designing, validating and testing your application, and (3) ensuring your application meets applicable standards, and any other safety, security, regulatory or other requirements.

These resources are subject to change without notice. TI grants you permission to use these resources only for development of an application that uses the TI products described in the resource. Other reproduction and display of these resources is prohibited. No license is granted to any other TI intellectual property right or to any third party intellectual property right. TI disclaims responsibility for, and you will fully indemnify TI and its representatives against, any claims, damages, costs, losses, and liabilities arising out of your use of these resources.

TI's products are provided subject to [TI's Terms of Sale](#) or other applicable terms available either on ti.com or provided in conjunction with such TI products. TI's provision of these resources does not expand or otherwise alter TI's applicable warranties or warranty disclaimers for TI products.

TI objects to and rejects any additional or different terms you may have proposed.

Mailing Address: Texas Instruments, Post Office Box 655303, Dallas, Texas 75265
Copyright © 2022, Texas Instruments Incorporated