

# UHF RFID Tag Data sheet

## LXMS21ACMF-218

### Scope

This Data sheet, is applied to passive UHF tag.

-Specific applications: To give ID (identification) to consumer product, consumer equipment, industrial equipment and medical equipment (GHTF Class A and B) or its consumables for individual management by using radio waves.

-Unsuitable Application: Applications listed in “Limitation of applications” in this Data sheet.

### 1. General descriptions

LXMS21ACMF-218 is an innovative RFID module designed to operate in electronic products/applications. It incorporates an industry standard IC.

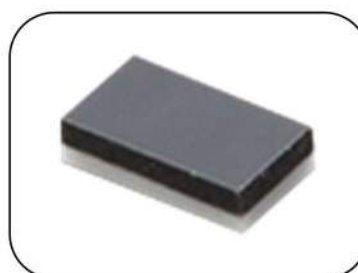

#### [Features]

- Small package design
- Reflow SMT compatible
- UHF band (865~928MHz)
- ISO18000-63 / EPC global Gen2 V2 Compliant
- Size is 2.0 x 1.2 x 0.5mm
- Using Impinj MonzaR6
- Read range:9m \*Reference
- RoHS compliant

### 2. Block diagram

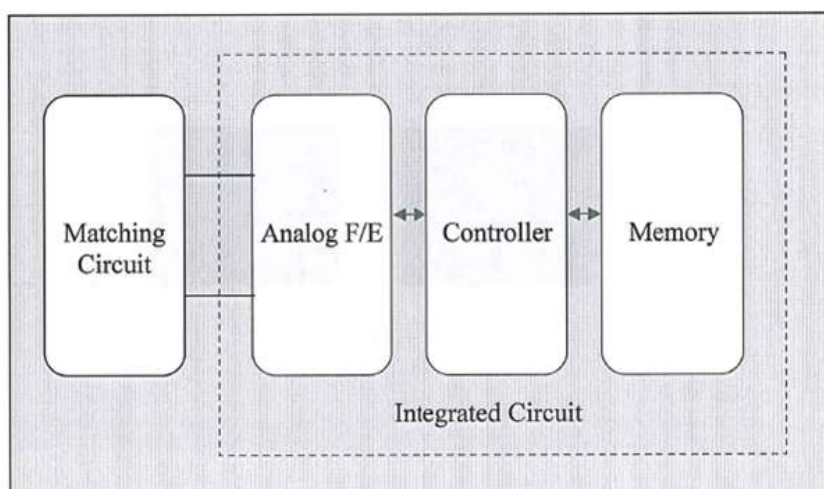

All Rights Reserved, Copyright© Murata Manufacturing Co., Ltd.  
< Specification is subject to change without notice >

**3. Mechanical information**

[Dimension]

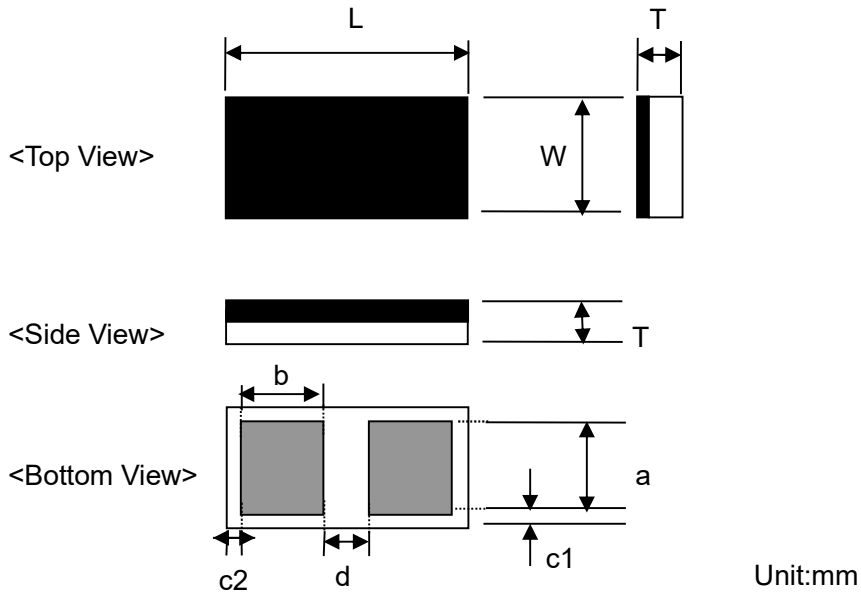

Unit:mm

Mark	Dimension	Mark	Dimension
L	2.00±0.15	b	0.6±0.1
W	1.20±0.15	c1	0.2±0.2
T	0.5MAX	c2	0.2±0.2
a	0.85±0.10	d	0.4±0.1

[Recommended land pattern]

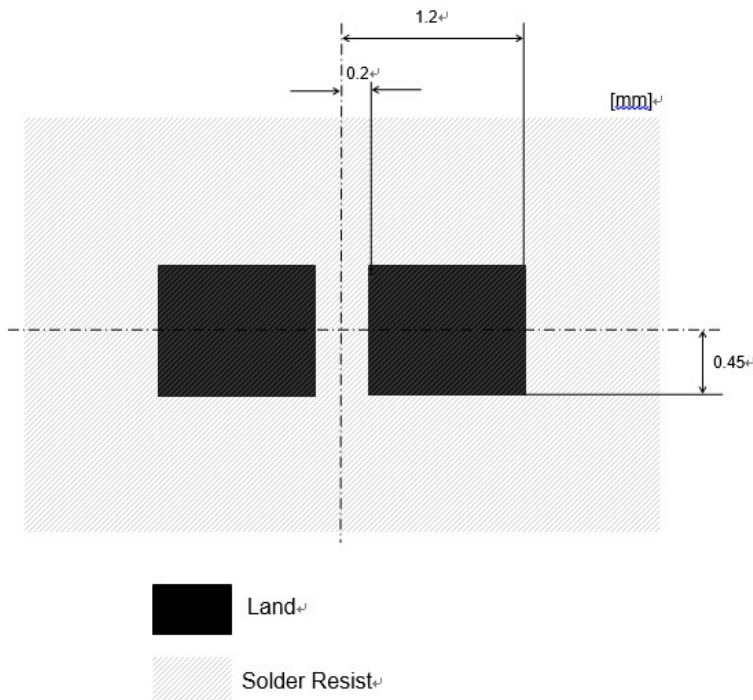

All Rights Reserved, Copyright© Murata Manufacturing Co., Ltd.  
< Specification is subject to change without notice >

**4. Electrical performance**

**4-1. Frequency range**

865 – 928MHz

**4-2. IC / Memory size**

Item		Description	Remarks
IC		Impinj MonzaR6	
Protocol		ISO/IEC 18000-63	
		EPC global Gen2 V2	
Memory	EPC	MAX 96 bit	Read & Write
	TID	96 bit	Read Only
	Reserved memory	N/A	
	User	N/A	
Data retention Time		※50years	Tamb = 22°C

※Reference value

**5. Reference antenna design on PCB**

**5-1. Top layer**

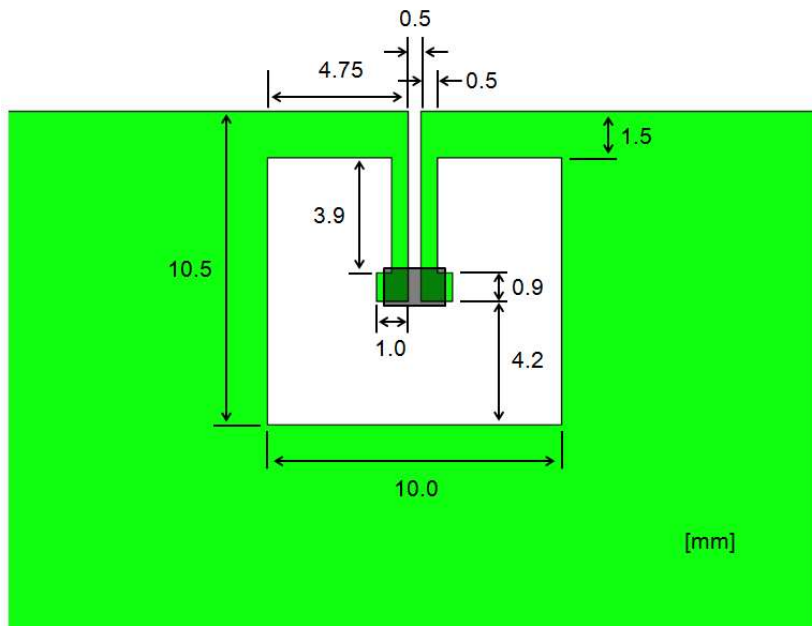

Mounting pattern (normal)  
Please conduct to PCB ground

**5-2. How to design layers below the mounting pattern**

Please remove all the copper pattern area from all layers of the PCB, if it is located under mounting pattern on surface layer.

Surface Layer



Other Layers

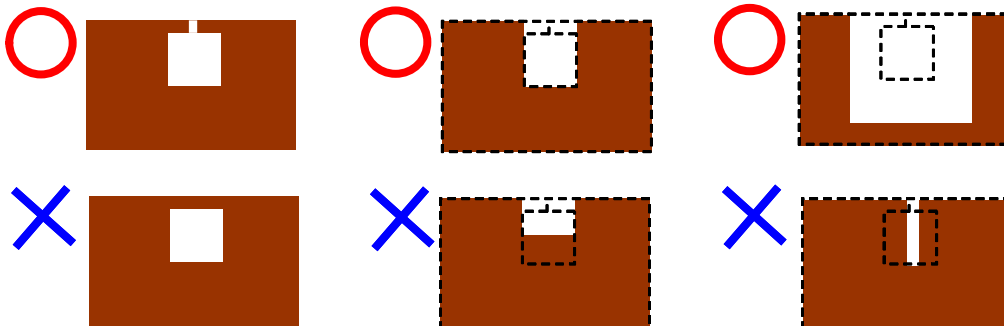

# UHF RFID Tag Data sheet LXMS21ACMF-218

## 5-3 how to put via hole

Please put via holes as shown in the figure below. If there is no via hole in multi layered PCB, unnecessary inductance degrade performance.

### 5-3-1 For normal pattern

The example of via hole layout

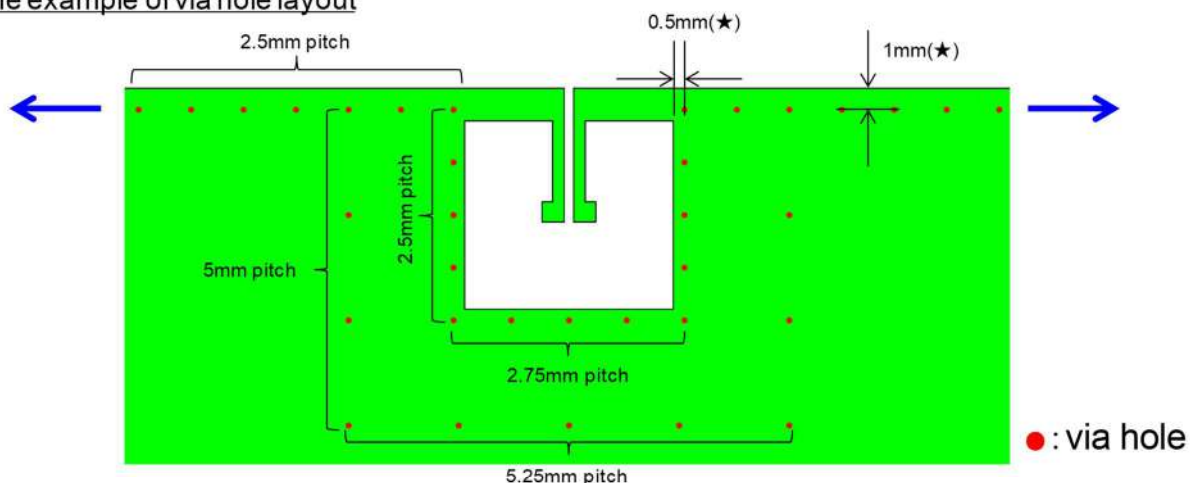

diameter: 0.3mm $\Phi$   
pitch : 2.5mm, 2.75mm(around pattern)  
5mm, 5.25 mm(other)

At the point of (★), The less value will get the less degradation.  
Also increasing the number of via holes will get PCB less degradation.  
At blue arrow direction, Please place the via holes to the edge of the board.  
(If there is a GND electrode on other layers)

### 5-3-2 For small pattern

The example of via hole layout

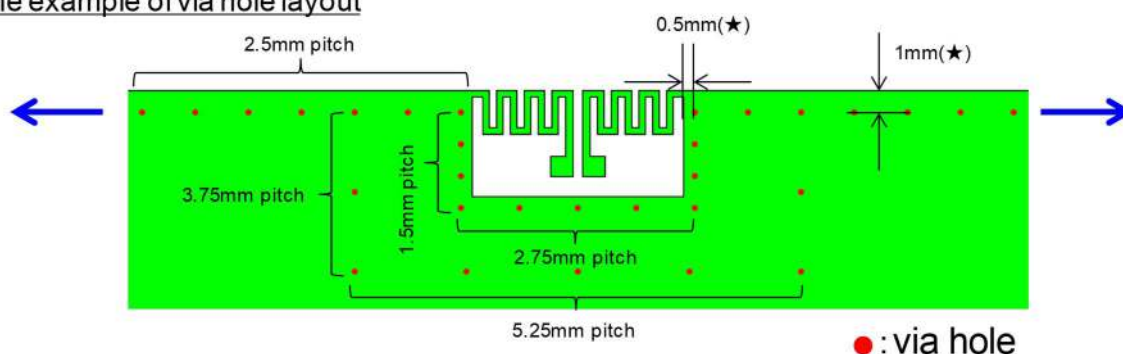

diameter: 0.3mm $\Phi$   
pitch : 1.5mm, 2.75mm(around pattern)  
3.75, 5.25 mm(other)

At the point of (★), The less value will get the less degradation.  
Also increasing the number of via holes will get PCB less degradation.  
At blue arrow direction, Please place the via holes to the edge of the board.  
(If there is a GND electrode on other layers)

All Rights Reserved, Copyright© Murata Manufacturing Co., Ltd.  
< Specification is subject to change without notice >

**5-4. Reading distance**

9m (typ) (at 4W EIRP, with 15cm length of PCB ground)

The reading distance of LXMS21ACMF -218 onto PCB, depends on the length of PCB ground.

**technical information**

Reading distance is derived by the parameters of mounting pattern and length of PCB ground.

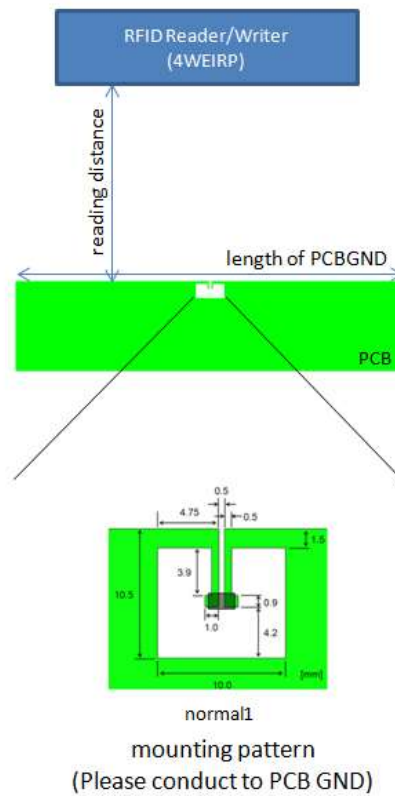
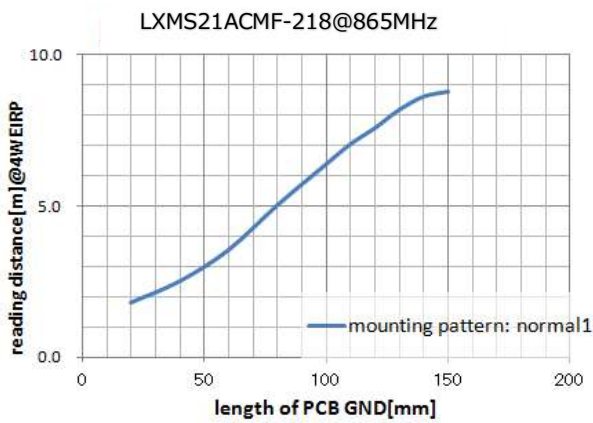
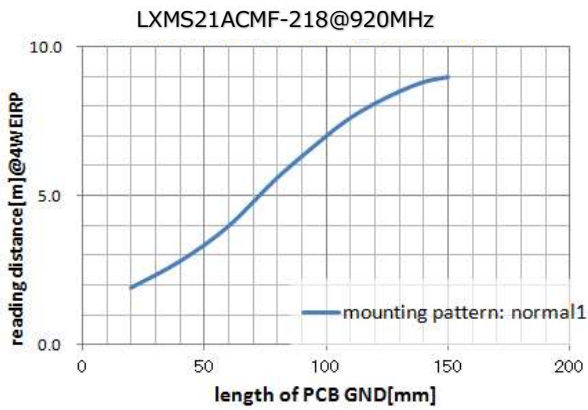

# UHF RFID Tag Data sheet LXMS21ACMF-218

## 5-5. Metal enclosure under printed circuit board

When the PCB is in close proximity to the metal enclosure, sensitivity is reduced. Removing material directly under the LXMS21ACMF-218 antenna pattern will greatly improve sensitivity.

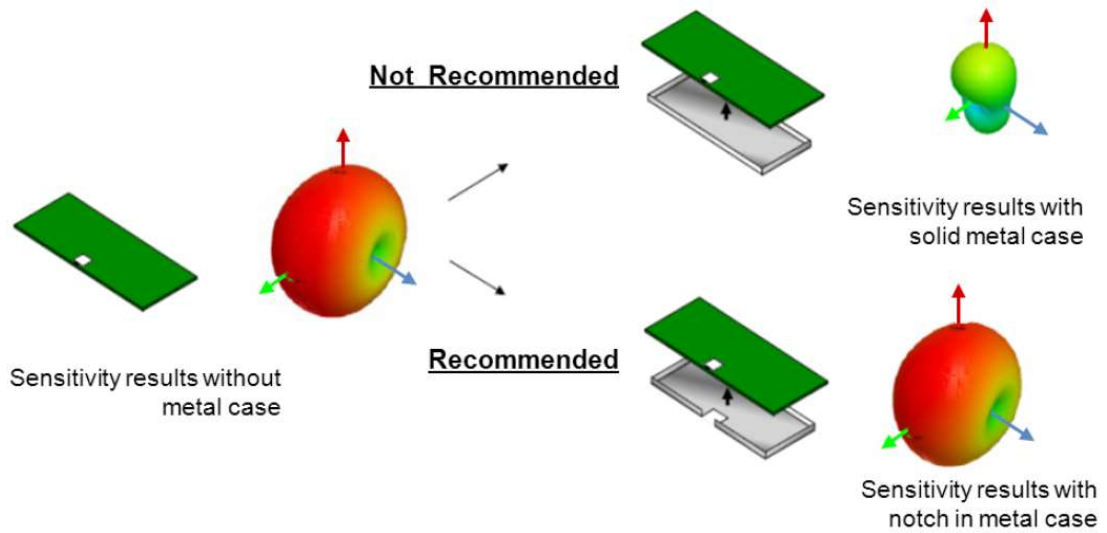

# UHF RFID Tag Data sheet LXMS21ACMF-218

## 5-6. Antenna location on PCB

Important area of PCB ground is the edge part shown as “dark green” below. The mounting pattern should be located closest to the edge of the PCB. Variations of ideal design are also acceptable.

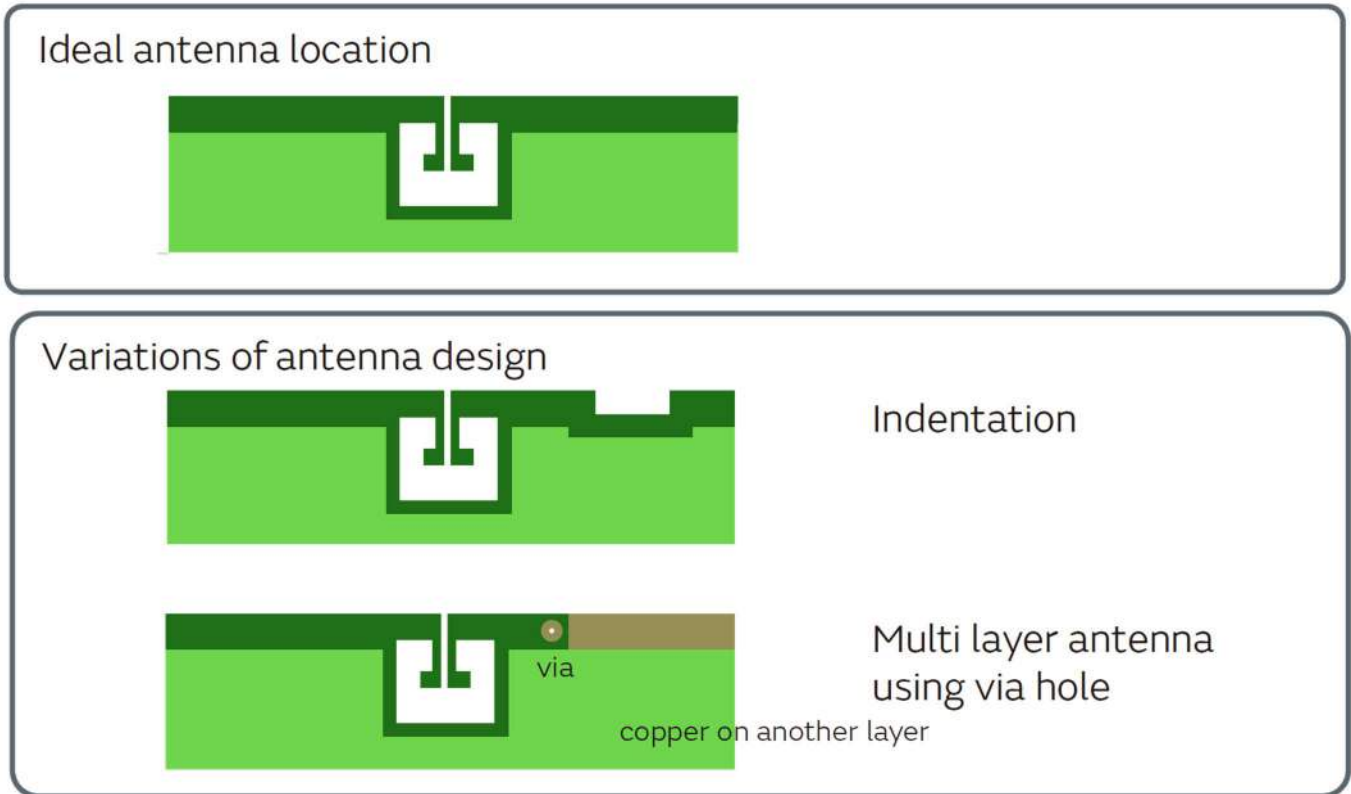

## 5-7. Position of LXMS21ACMF-218 on PCB

LXMS21ACMF-218 should be centered on the long side of the PCB to maximize read range. The following illustrates the relationship between “X” length and read range.

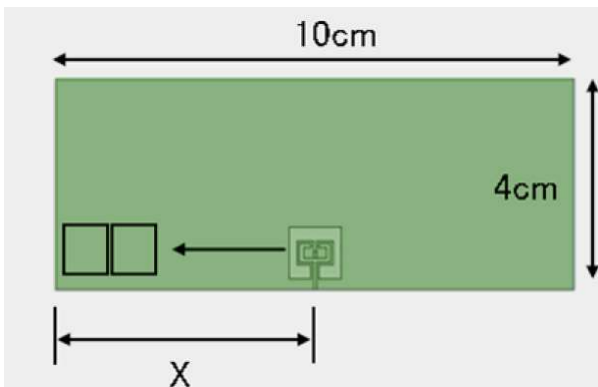

Length “X” (cm)	Read Range (m)
5	7
2	5
1	3.5



**6. Absolute maximum ratings**

Symbol	Parameter	Min	Max	Unit
T <sub>stg</sub>	Storage temperature	-40	+85	°C
T <sub>amb</sub>	Operating temperature	-40	+85	°C
P <sub>max</sub>	Total Power Dissipation		100	mW

**7. Packaging**

**7-1. Dimensions of tape**

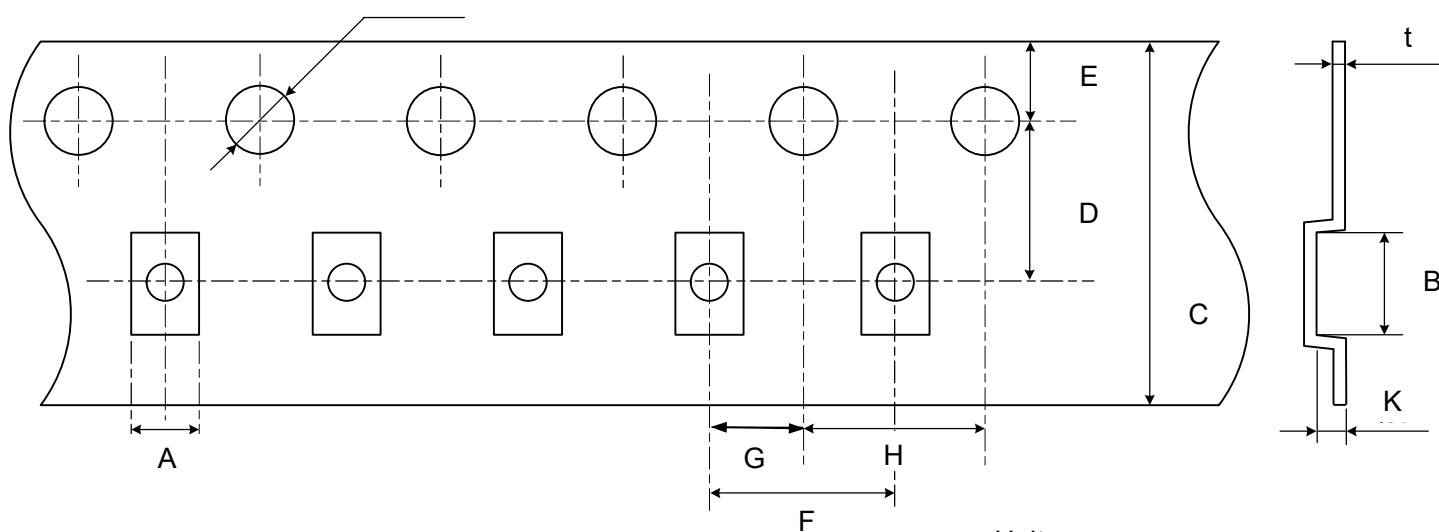

Unit: mm

Symbol	A	B	C	D	E	F
Dimension	1.50±0.1	2.25±0.1	8.0±0.2	3.5±0.05	1.75±0.1	4.0±0.1

Symbol	G	H	J	K	t
Dimension	2.0±0.05	4.0±0.1	1.5±0.1	0.60±0.05	0.25±0.05

7-2. Dimensions of reel

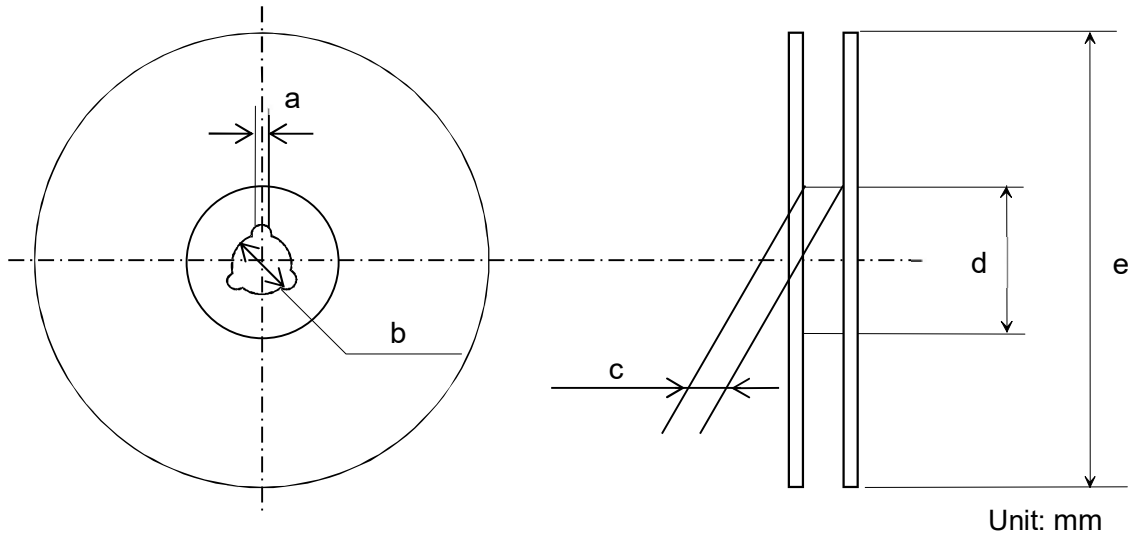

Symbol	a	b	c	d	e
Dimension	2.0+/-0.5	Φ13.0+/-0.2	9.0+/-0.3	(Φ60)	(Φ180)

7-3. Packing (Moisture-proof package)

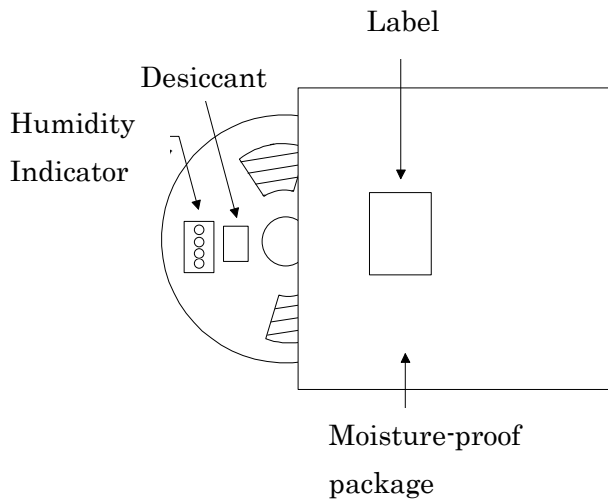

Reel will be packed in moisture-proof package together with desiccant and humidity indicator. After packing, the package will be heat-sealed.

7-4. Taping Diagrams

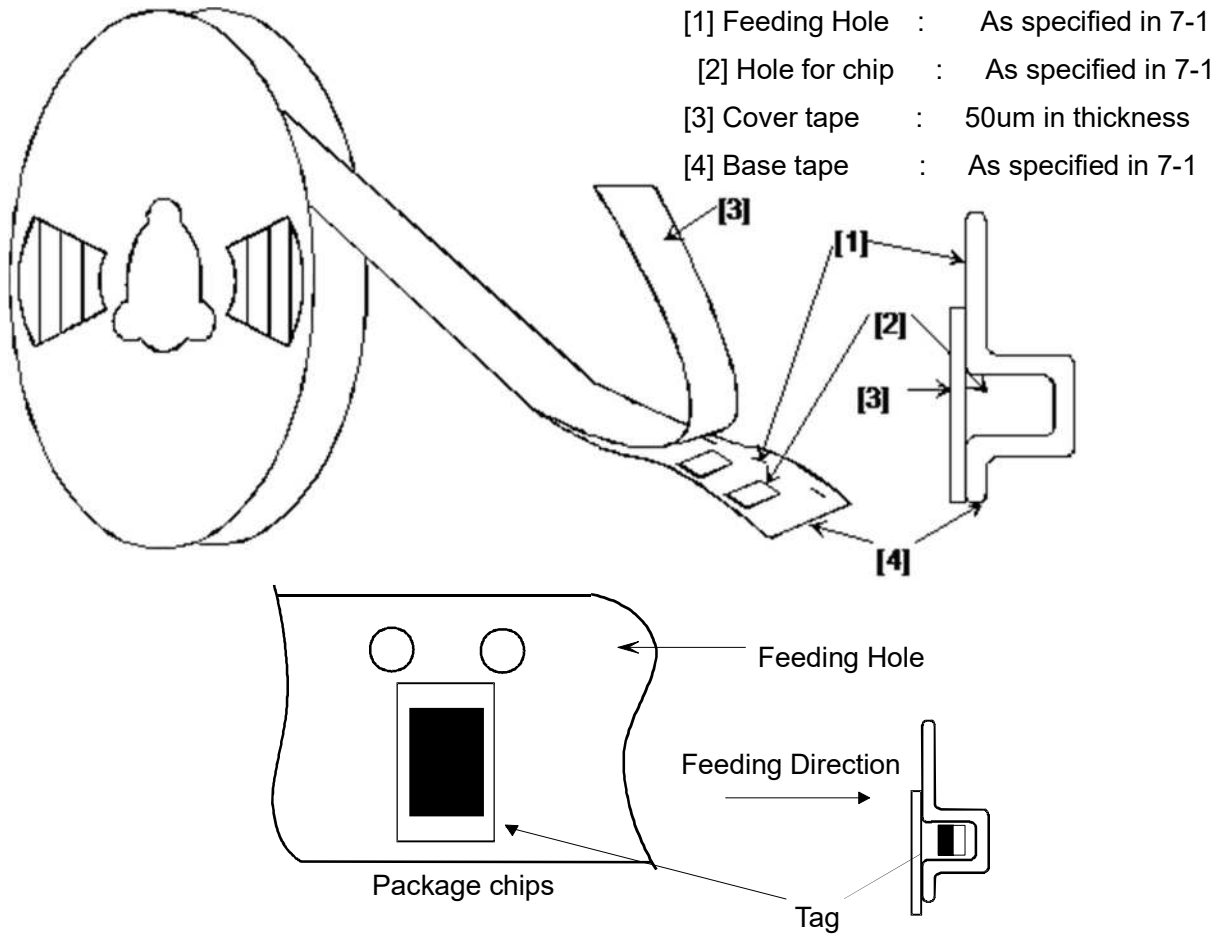

**7-5. Leader and Tail tape**

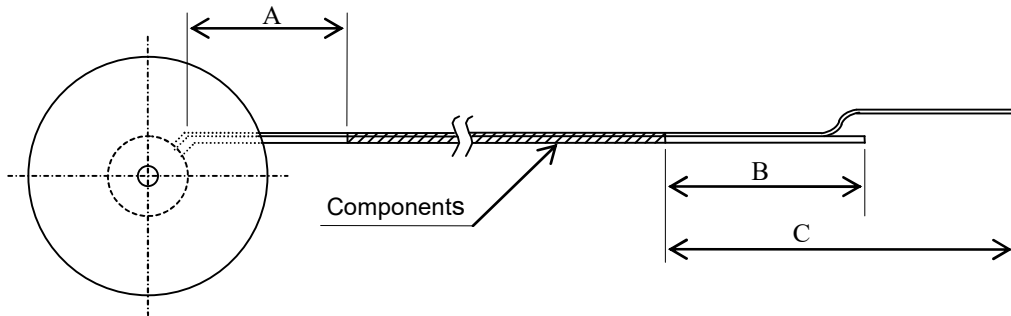

Unit : mm

Symbol	Item	Minimum length
A	Tail	160
B	Leader no components	100
C	Leader with cover tape	400

**7-6. Taping direction**

The tape for chips are wound clockwise.

The feeding holes will come on the right side when the tape is pulled to a user's direction.

**7-7. Quantity per reel**

5,000 pcs

**7-8. Minimum order quantity**

5,000pcs

**7-9. Material**

Base and Cover tape : Plastic

Reel : Plastic

Base and Cover tape, Reel have an anti-ESD function.

**7-10. Peeling force**

0.1~1.0 N in the direction of peeling as shown below.

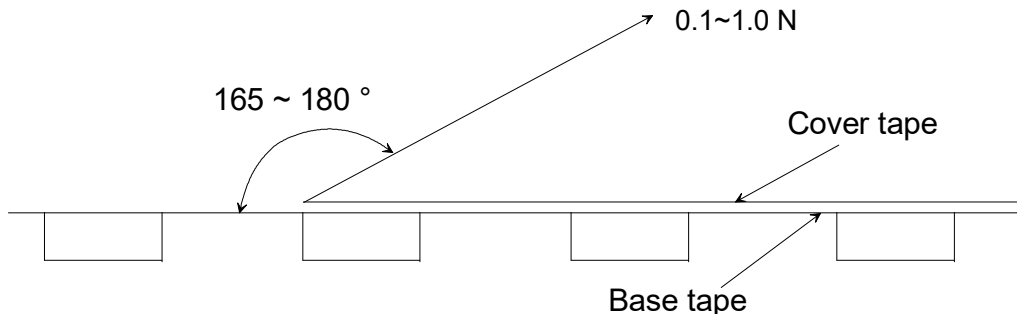

## **8. Contact window**

URL: <http://www.murata.com/products/rfid>

Email: [magicstrap@murata.com](mailto:magicstrap@murata.com)

For any inquiries/queries, please feel free to contact us.

## NOTICE

### 1. Storage Conditions:

To avoid damaging the solderability of the external electrodes, be sure to observe the following points.

- The product shall be stored without opening the packing under the ambient temperature from 5 to 35 deg.C and humidity from 20 to 70%RH.

(Packing materials, in particular, may be deformed at the temperature over 40 deg.C.)

- The product left more than 6 months after reception, it needs to be baked and confirmed the solderability before use.

(Since adhesive tape, tape, and reel are not resistant to heat, baking with tape and reel is not possible. In case baking is necessary, please place the product into a heat resistant container. Baking condition should be 125deg.C, 24hours, once. )

- The product shall be stored in non corrosive gas (Cl<sub>2</sub>, NH<sub>3</sub>, SO<sub>2</sub>, No<sub>x</sub>, etc.).

- Environment with high temperature or excessive temperature shift might cause dew condensation and deterioration of product performance and solderability.

- After the packing opened, the product shall be stored at  $\leq 30$  deg.C /  $\leq 60$  %RH.

- When the color of the indicator in the packing changed, the product shall be baked before soldering.

- This product is applicable to MSL2 (Based on IPC/JEDEC J-STD-020)

### 2. Handling Conditions:

Be careful in handling or transporting products because excessive stress or mechanical shock may break products.

Handle with care if products may have cracks or damages on their terminals, the characteristics of products may change. Do not touch products with bare hands that may result in poor solderability.

## UHF RFID Tag Data sheet LXMS21ACMF-218

### 3. Standard PCB Design (Land Pattern and Dimensions):

Please refer to the drawing 1 for the standard land dimensions.

The recommended land pattern and dimensions is as Murata's standard. The characteristics of products may vary depending on the pattern drawing method, grounding method, land dimensions, PCB material, and thickness.

Therefore, be sure to verify the characteristics in the actual system if not using non-standard lands.

### 4. Notice for Chip Placer:

When placing products on the PCB, products may be stressed and broken by uneven forces from a worn-out chucking locating claw or a suction nozzle. To prevent products from damages, be sure to follow the specifications for the maintenance of the chip placer being used. For the positioning of products on the PCB, be aware that mechanical chucking may damage products.

**5. Soldering Conditions:**

Do not solder the product exceeding two times.

Carefully perform preheating so that the temperature difference ( $\Delta T$ ) between the solder and products surface should be within 130°C.

When products are immersed in solvent after mounting, pay special attention to maintain the temperature difference within 100 °C.

Soldering must be carried out by the above mentioned conditions to prevent products from damage. Contact Murata before use if concerning other soldering conditions.

**Reflow soldering standard conditions(Example)**

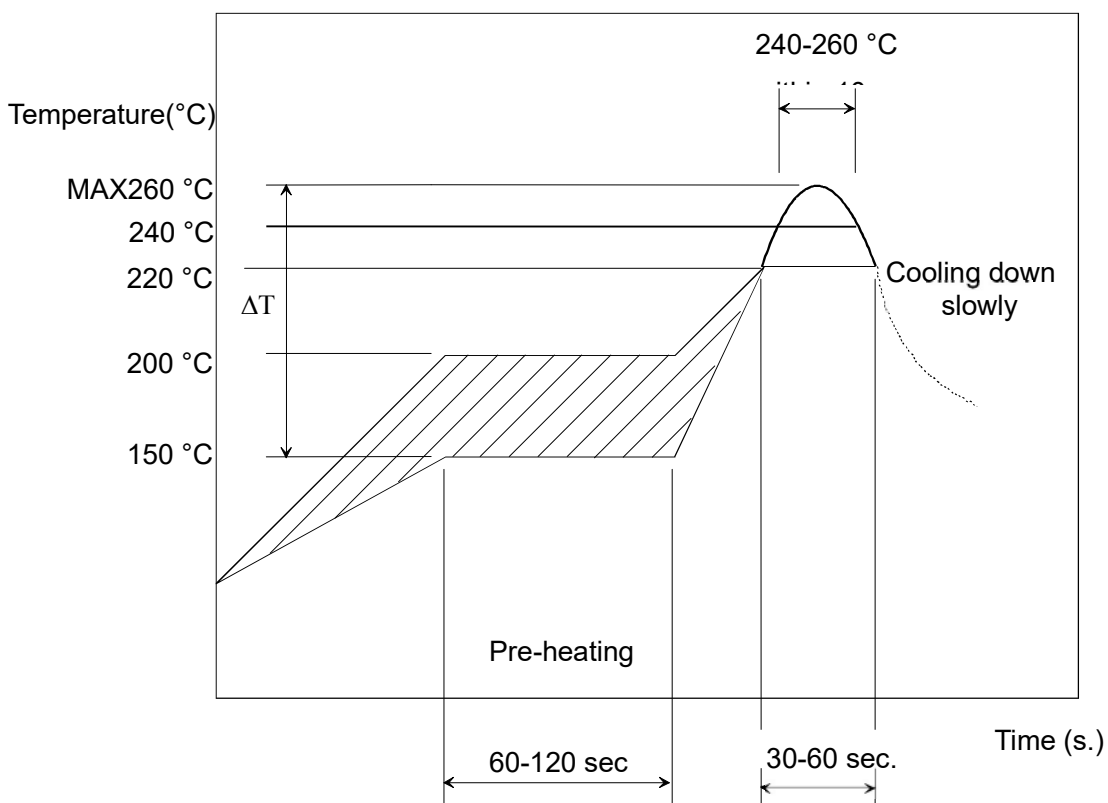

Use rosin type flux or weakly active flux with a chlorine content of 0.2 wt % or less.

**6. Input Power Capacity:**

Products shall be used in the input power capacity as specified in this specifications.

Inform Murata beforehand, in case that the components are used beyond such input power capacity range.

**7. Cleaning Conditions:**

If the cleaning will be applied, please check with Murata in advance since the product may degrade or get broken.

**All Rights Reserved, Copyright© Murata Manufacturing Co., Ltd.**

< Specification is subject to change without notice >



**8. Operational Environment Conditions:**

Products are designed to work for electronic products under normal environmental conditions (ambient temperature, humidity and pressure). Therefore, products have no problems to be used under the similar conditions to the above-mentioned. However, if products are used under the following circumstances, it may damage products and leakage of electricity and abnormal temperature may occur.

- In an atmosphere containing corrosive gas ( Cl<sub>2</sub>, NH<sub>3</sub>, SO<sub>x</sub>, NO<sub>x</sub> etc.).
- In an atmosphere containing combustible and volatile gases.
- In a dusty environment.
- Direct sunlight
- Water splashing place.
- Humid place where water condenses.
- In a freezing environment.

If there are possibilities for products to be used under the preceding clause, consult with Murata before actual use.

If static electricity is added to this product, degradation and destruction may be produced.

Please use it after consideration enough so that neither static electricity nor excess voltage is added at the time of an assembly and measurement.

If product malfunctions may result in serious damage, including that to human life, alternative measures of the operation and design must be taken to secure the safety.

## UHF RFID Tag Data sheet LXMS21ACMF-218

### 9. Limitation of Applications:

The products listed in the Data sheet (hereinafter the product(s) is called as the “Product(s)”) are designed and manufactured for applications specified in the Data sheet. (hereinafter called as the “Specific Application”).

We shall not warrant anything in connection with the Products including fitness, performance, adequateness, safety, or quality, in the case of applications listed in from (1) to (11) written at the end of this precautions, which may generally require high performance, function, quality, management of production or safety. Therefore, the Product shall be applied in compliance with the specific application.

WE DISCLAIM ANY LOSS AND DAMAGES ARISING FROM OR IN CONNECTION WITH THE PRODUCTS INCLUDING BUT NOT LIMITED TO THE CASE SUCH LOSS AND DAMAGES CAUSED BY THE UNEXPECTED ACCIDENT, IN EVENT THAT (i) THE PRODUCT IS APPLIED FOR THE PURPOSE WHICH IS NOT SPECIFIED AS THE SPECIFIC APPLICATION FOR THE PRODUCT, AND/OR (ii) THE PRODUCT IS APPLIED FOR ANY FOLLOWING APPLICATION PURPOSES FROM (1) TO (11) (EXCEPT THAT SUCH APPLICATION PURPOSE IS UNAMBIGUOUSLY SPECIFIED AS SPECIFIC APPLICATION FOR THE PRODUCT IN OUR CATALOG SPECIFICATION FORMS, DATASHEETS, OR OTHER DOCUMENTS OFFICIALLY ISSUED BY US\*).

- (1) Aircraft equipment
- (2) Aerospace equipment
- (3) Undersea equipment
- (4) Power plant control equipment
- (5) Medical equipment
- (6) Transportation equipment
- (7) Traffic control equipment
- (8) Disaster prevention/security equipment
- (9) Industrial data-processing equipment
- (10) Combustion/explosion control equipment
- (11) Equipment with complexity and/or required reliability equivalent to the applications listed in the above.

For exploring information of the Products which will be compatible with the particular purpose other than those specified in the Data sheet, please contact our sales offices, distribution agents, or trading companies with which you make a deal, or via our web contact form.

Contact form: <https://www.murata.com/contactform>

\*We may design and manufacture particular Products for applications listed in (1) to (11). Provided that, in such case we shall unambiguously specify such Specific Application in the Data sheet without any exception. Therefore, any other documents and/or performances, whether exist or non-exist, shall not be deemed as the evidence to imply that we accept the applications listed in (1) to (11).

**All Rights Reserved, Copyright© Murata Manufacturing Co., Ltd.**  
< Specification is subject to change without notice >



Please make sure that your product has been evaluated and confirmed against your specifications when our product is mounted to your product.

All the items and parameters in this product specification have been prescribed on the premise that our product is used for the purpose, under the condition and in the environment agreed upon between you and us. You are requested not to use our product deviating from such agreement.