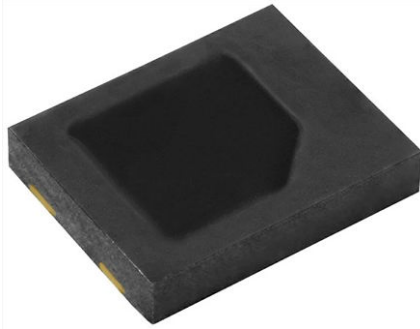


Silicon PIN Photodiode



DESCRIPTION

VEMD5110X01 is a high speed and high sensitive PIN photodiode. It is a low profile surface mount device (SMD) including the chip with a 7.5 mm² sensitive area and a daylight blocking filter matched with IR emitters operating at wavelength 870 nm or 950 nm.

FEATURES

- Package type: surface mount
- Package form: top view
- Dimensions (L x W x H in mm): 5 x 4 x 0.9
- Radiant sensitive area (in mm²): 7.5
- AEC-Q101 qualified
- High radiant sensitivity
- Daylight blocking filter matched with 870 nm to 950 nm emitters
- Fast response times
- Angle of half sensitivity: $\phi = \pm 65^\circ$
- Floor life: 72 h, MSL 4, according to J-STD-020
- Material categorization: for definitions of compliance please see www.vishay.com/doc?99912

 AUTOMOTIVE
GRADE

RoHS
COMPLIANT
HALOGEN
FREE
GREEN
(5-2008)

APPLICATIONS

- High speed detector for infrared radiation
- Infrared remote control and free air data transmissionsystems, e.g. road cash systems
- Photodiode for smoke detectors
- Photodiode for rain sensors

PRODUCT SUMMARY

COMPONENT	I_{ra} (μA)	ϕ (deg)	$\lambda_{0.5}$ (nm)
VEMD5110X01	48	± 65	790 to 1050

Note

- Test conditions see table "Basic Characteristics"

ORDERING INFORMATION

ORDERING CODE	PACKAGING	REMARKS	PACKAGE FORM
VEMD5110X01	Tape and reel	MOQ: 1000 pcs, 1000 pcs/reel	Top view
VEMD5110X01-GS15	Tape and reel	MOQ: 5000 pcs, 5000 pcs/reel	Top view

Note

- MOQ: minimum order quantity

ABSOLUTE MAXIMUM RATINGS ($T_{amb} = 25^\circ C$, unless otherwise specified)

PARAMETER	TEST CONDITION	SYMBOL	VALUE	UNIT
Reverse voltage		V_R	20	V
Power dissipation	$T_{amb} \leq 25^\circ C$	P_V	215	mW
Junction temperature		T_j	110	$^\circ C$
Operating temperature range		T_{amb}	-40 to +110	$^\circ C$
Storage temperature range		T_{stg}	-40 to +110	$^\circ C$
Soldering temperature	Acc. reflow solder profile fig. 8	T_{sd}	260	$^\circ C$
Thermal resistance junction/ambient		R_{thJA}	350	K/W
ESD safety HBM	± 2000 V, 1.5 k Ω , 100 pF, 3 pulses	ESD_{HBM}	≥ 2	kV

BASIC CHARACTERISTICS ($T_{amb} = 25\text{ }^{\circ}\text{C}$, unless otherwise specified)						
PARAMETER	TEST CONDITION	SYMBOL	MIN.	TYP.	MAX.	UNIT
Forward voltage	$I_F = 50\text{ mA}$	V_F		1	1.3	V
Breakdown voltage	$I_R = 100\text{ }\mu\text{A}$, $E = 0$	$V_{(BR)}$	20			V
Reverse dark current	$V_R = 10\text{ V}$, $E = 0$	I_{ro}		2	30	nA
Diode capacitance	$V_R = 0\text{ V}$, $f = 1\text{ MHz}$, $E = 0$	C_D		70		pF
	$V_R = 3\text{ V}$, $f = 1\text{ MHz}$, $E = 0$	C_D		25	40	pF
Open circuit voltage	$E_e = 1\text{ mW/cm}^2$, $\lambda = 950\text{ nm}$	V_o		350		mV
Temperature coefficient of V_o	$E_e = 1\text{ mW/cm}^2$, $\lambda = 950\text{ nm}$	TK_{V_o}		-2.6		mV/K
Short circuit current	$E_e = 1\text{ mW/cm}^2$, $\lambda = 950\text{ nm}$	I_k		45		μA
Temperature coefficient of I_k	$E_e = 1\text{ mW/cm}^2$, $\lambda = 950\text{ nm}$	TK_{I_k}		0.1		%/K
Reverse light current	$E_e = 1\text{ mW/cm}^2$, $\lambda = 950\text{ nm}$, $V_R = 5\text{ V}$	I_{ra}	40	48		μA
Angle of half sensitivity		φ		± 65		deg
Wavelength of peak sensitivity		λ_p		940		nm
Range of spectral bandwidth		$\lambda_{0.5}$		790 to 1050		nm
Noise equivalent power	$V_R = 10\text{ V}$, $\lambda = 950\text{ nm}$	NEP		4×10^{-14}		W//Hz
Rise time	$V_R = 10\text{ V}$, $R_L = 1\text{ k}\Omega$, $\lambda = 820\text{ nm}$	t_r		100		ns
Fall time	$V_R = 10\text{ V}$, $R_L = 1\text{ k}\Omega$, $\lambda = 820\text{ nm}$	t_f		100		ns

BASIC CHARACTERISTICS ($T_{amb} = 25\text{ }^{\circ}\text{C}$, unless otherwise specified)

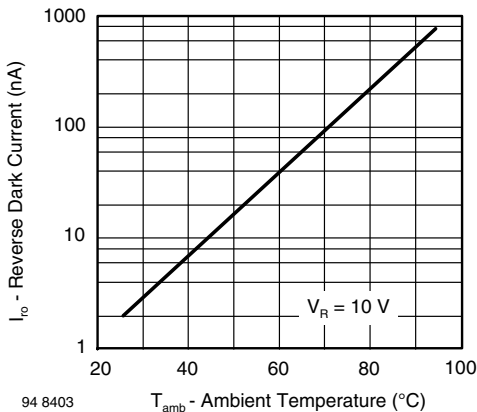
 Basic characteristics graphs to be extended to $110\text{ }^{\circ}\text{C}$ ambient temperatures where applicable.


Fig. 1 - Reverse Dark Current vs. Ambient Temperature

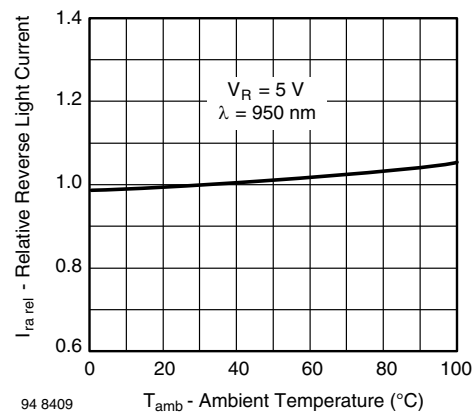


Fig. 2 - Relative Reverse Light Current vs. Ambient Temperature

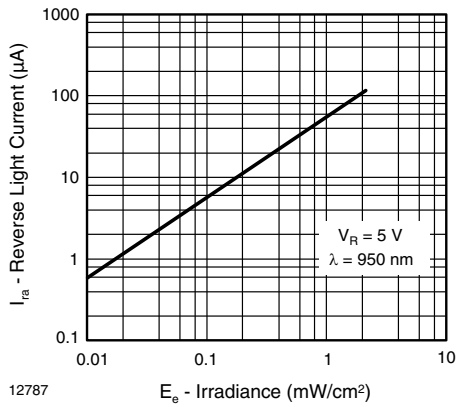


Fig. 3 - Reverse Light Current vs. Irradiance

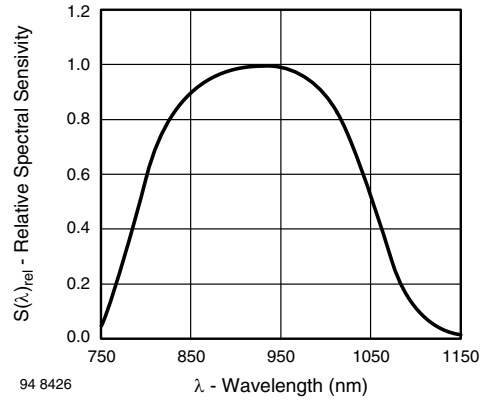


Fig. 6 - Relative Spectral Sensitivity vs. Wavelength

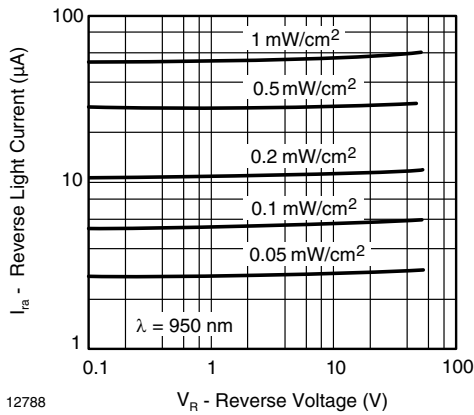


Fig. 4 - Reverse Light Current vs. Reverse Voltage

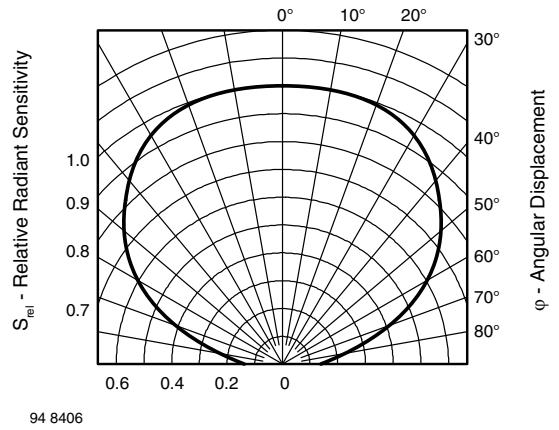


Fig. 7 - Relative Radiant Sensitivity vs. Angular Displacement

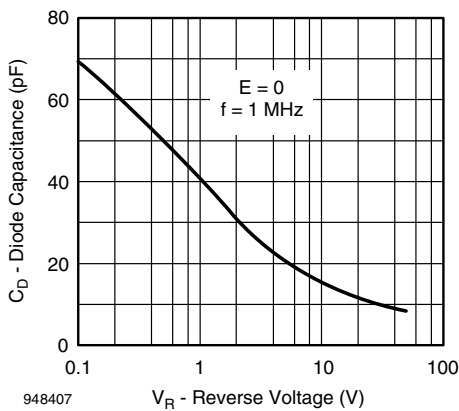
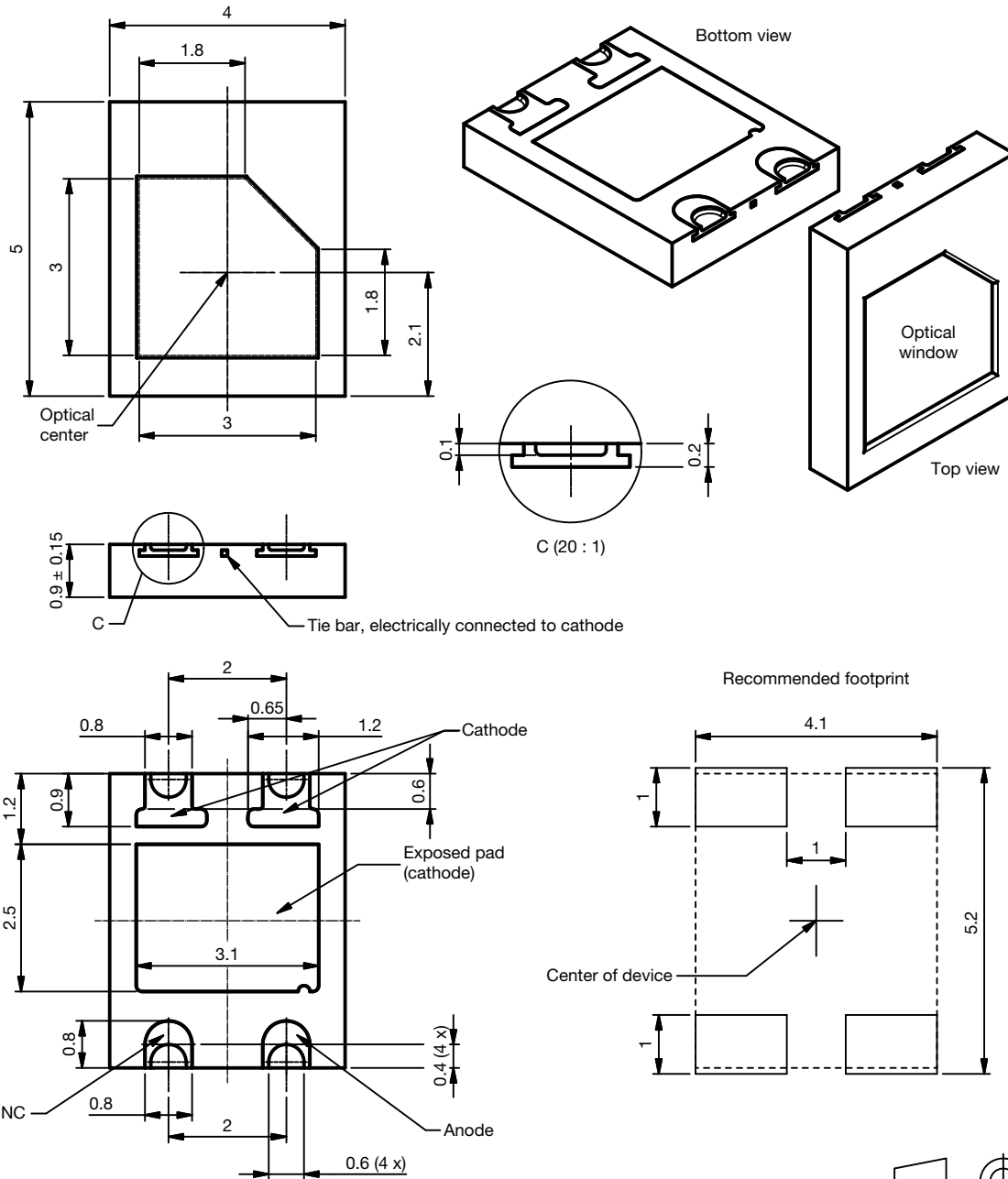


Fig. 5 - Diode Capacitance vs. Reverse Voltage

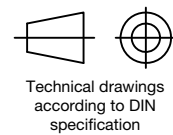


PACKAGE DIMENSIONS in millimeters



Drawing- No.: 6.550-5329.01-4
Issue: 2; 03.03.2016

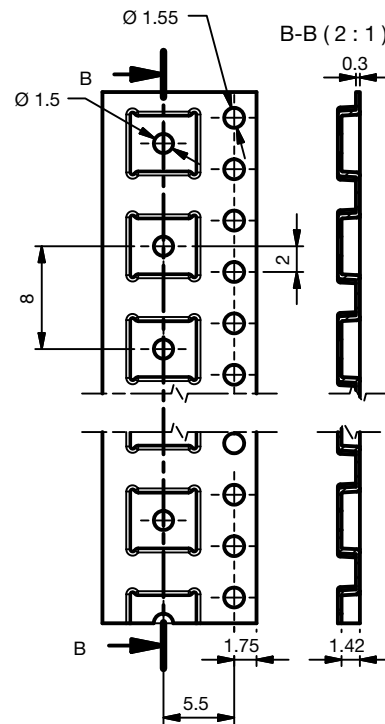
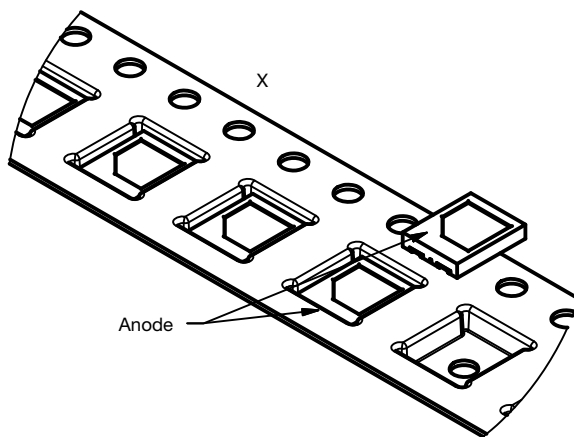
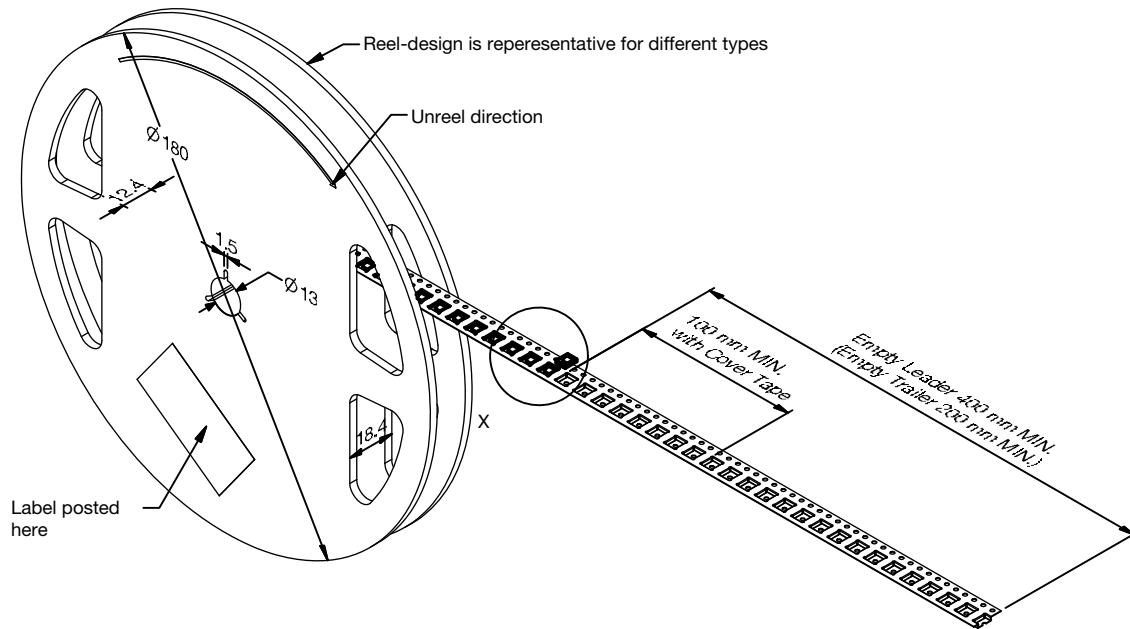
Not indicated tolerances ± 0.1



Technical drawings according to DIN specification

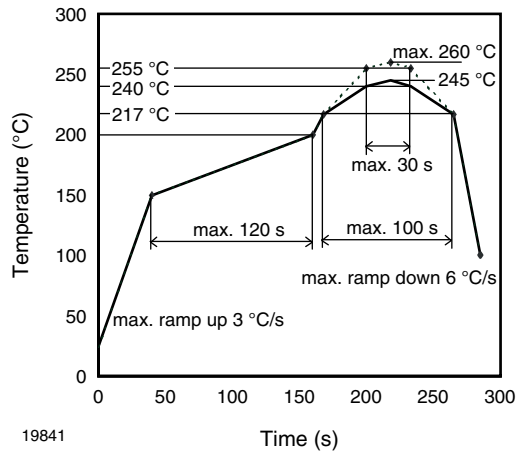


TAPE AND REEL DIMENSIONS in millimeters



Drawing-No.: 9.800-5129.01-4;
Issue: 1; 20.07.2015

SOLDER PROFILE



19841
 Fig. 8 - Lead (Pb)-free Reflow Solder Profile
 acc. J-STD-020D

DRYPACK

Devices are packed in moisture barrier bags (MBB) to prevent the products from moisture absorption during transportation and storage. Each bag contains a desiccant.

FLOOR LIFE

Time between soldering and removing from MBB must not exceed the time indicated in J-STD-020:
 Moisture sensitivity: Level 4
 Floor life: 72 h
 Conditions: $T_{amb} < 30\text{ }^{\circ}\text{C}$, RH < 60 %

DRYING

In case of moisture absorption devices should be baked before soldering. Conditions see J-STD-020 or recommended conditions:
 192 h at 40 °C (+ 5 °C), RH < 5 %
 or
 96 h at 60 °C (+ 5 °C), RH < 5 %.



Disclaimer

ALL PRODUCT, PRODUCT SPECIFICATIONS AND DATA ARE SUBJECT TO CHANGE WITHOUT NOTICE TO IMPROVE RELIABILITY, FUNCTION OR DESIGN OR OTHERWISE.

Vishay Intertechnology, Inc., its affiliates, agents, and employees, and all persons acting on its or their behalf (collectively, "Vishay"), disclaim any and all liability for any errors, inaccuracies or incompleteness contained in any datasheet or in any other disclosure relating to any product.

Vishay makes no warranty, representation or guarantee regarding the suitability of the products for any particular purpose or the continuing production of any product. To the maximum extent permitted by applicable law, Vishay disclaims (i) any and all liability arising out of the application or use of any product, (ii) any and all liability, including without limitation special, consequential or incidental damages, and (iii) any and all implied warranties, including warranties of fitness for particular purpose, non-infringement and merchantability.

Statements regarding the suitability of products for certain types of applications are based on Vishay's knowledge of typical requirements that are often placed on Vishay products in generic applications. Such statements are not binding statements about the suitability of products for a particular application. It is the customer's responsibility to validate that a particular product with the properties described in the product specification is suitable for use in a particular application. Parameters provided in datasheets and / or specifications may vary in different applications and performance may vary over time. All operating parameters, including typical parameters, must be validated for each customer application by the customer's technical experts. Product specifications do not expand or otherwise modify Vishay's terms and conditions of purchase, including but not limited to the warranty expressed therein.

Hyperlinks included in this datasheet may direct users to third-party websites. These links are provided as a convenience and for informational purposes only. Inclusion of these hyperlinks does not constitute an endorsement or an approval by Vishay of any of the products, services or opinions of the corporation, organization or individual associated with the third-party website. Vishay disclaims any and all liability and bears no responsibility for the accuracy, legality or content of the third-party website or for that of subsequent links.

Except as expressly indicated in writing, Vishay products are not designed for use in medical, life-saving, or life-sustaining applications or for any other application in which the failure of the Vishay product could result in personal injury or death. Customers using or selling Vishay products not expressly indicated for use in such applications do so at their own risk. Please contact authorized Vishay personnel to obtain written terms and conditions regarding products designed for such applications.

No license, express or implied, by estoppel or otherwise, to any intellectual property rights is granted by this document or by any conduct of Vishay. Product names and markings noted herein may be trademarks of their respective owners.