



Circuit breaker size S00 for transformer protection A-release 0.28...0.4 A N-release 8.2 A screw terminal Standard switching capacity

|  |                            |
|--|----------------------------|
| <b>product brand name</b>  | SIRIUS                     |
| <b>product designation</b>   | Circuit breaker            |
| <b>design of the product</b>   | For transformer protection |
| <b>product type designation</b>  | 3RV2                       |
| <b>General technical data</b>  |                            |
| <b>size of the circuit-breaker</b>   | S00                        |
| <b>size of contactor can be combined company-specific</b>                                  | S00, S0                    |
| product extension auxiliary switch   | Yes                        |
| <b>power loss [W] for rated value of the current</b>                                       |                            |
| • at AC in hot operating state   | 5.5 W                      |
| • at AC in hot operating state per pole  | 1.8 W                      |
| insulation voltage with degree of pollution 3 at AC rated value                            | 690 V                      |
| <b>surge voltage resistance rated value</b>  | 6 kV                       |
| shock resistance according to IEC 60068-2-27   | 25g / 11 ms                |
| <b>mechanical service life (switching cycles)</b>  |                            |
| • of the main contacts typical   | 100 000                    |
| • of auxiliary contacts typical  | 100 000                    |
| electrical endurance (switching cycles) typical  | 100 000                    |
| <b>reference code according to IEC 81346-2</b>   | Q                          |
| <b>Substance Prohibitive (Date)</b>  | 10/01/2009                 |
| <b>Ambient conditions</b>  |                            |
| installation altitude at height above sea level maximum                                    | 2 000 m                    |
| <b>ambient temperature</b>   |                            |
| • during operation   | -20 ... +60 °C             |
| • during storage   | -50 ... +80 °C             |
| • during transport   | -50 ... +80 °C             |
| relative humidity during operation   | 10 ... 95 %                |
| <b>Main circuit</b>  |                            |
| <b>number of poles for main current circuit</b>  | 3                          |
| <b>adjustable current response value current of the current-dependent overload release</b> | 0.28 ... 0.4 A             |
| <b>operating voltage</b>   |                            |
| • rated value  | 20 ... 690 V               |
| • at AC-3 rated value maximum  | 690 V                      |
| • at AC-3e rated value maximum   | 690 V                      |
| <b>operating frequency rated value</b>   | 50 ... 60 Hz               |
| <b>operational current rated value</b>   | 0.4 A                      |
| <b>operational current</b>   |                            |
| • at AC-3 at 400 V rated value   | 0.4 A                      |

|   |  |
|---|--|
| <ul style="list-style-type: none"> <li>at AC-3e at 400 V rated value</li> </ul>   | 0.4 A  |
| <b>operating power</b>  |  |
| <ul style="list-style-type: none"> <li>at AC-3 <ul style="list-style-type: none"> <li>at 230 V rated value</li> <li>at 400 V rated value</li> <li>at 500 V rated value</li> <li>at 690 V rated value</li> </ul> </li> <li>at AC-3e <ul style="list-style-type: none"> <li>at 230 V rated value</li> <li>at 400 V rated value</li> <li>at 500 V rated value</li> <li>at 690 V rated value</li> </ul> </li> </ul> | 0.1 kW<br>0.1 kW<br>0.1 kW<br>0.2 kW<br><br>0.1 kW<br>0.1 kW<br>0.1 kW<br>0.2 kW       |
| <b>operating frequency</b>  |  |
| <ul style="list-style-type: none"> <li>at AC-3 maximum</li> <li>at AC-3e maximum</li> </ul>   | 15 1/h<br>15 1/h   |
| <b>Auxiliary circuit</b>  |  |
| <b>number of NC contacts for auxiliary contacts</b>   | 0  |
| <b>number of NO contacts for auxiliary contacts</b>   | 0  |
| number of CO contacts for auxiliary contacts  | 0  |
| <b>Protective and monitoring functions</b>  |  |
| <b>product function</b>   |  |
| <ul style="list-style-type: none"> <li>ground fault detection</li> <li>phase failure detection</li> </ul>   | No<br>Yes  |
| <b>trip class</b>   | CLASS 10   |
| <b>design of the overload release</b>   | thermal  |
| <b>breaking capacity maximum short-circuit current (Icu)</b>  |  |
| <ul style="list-style-type: none"> <li>at AC at 240 V rated value</li> <li>at AC at 400 V rated value</li> <li>at AC at 500 V rated value</li> <li>at AC at 690 V rated value</li> </ul>  | 100 kA<br>100 kA<br>100 kA<br>100 kA   |
| <b>breaking capacity operating short-circuit current (Ics) at AC</b>  |  |
| <ul style="list-style-type: none"> <li>at 240 V rated value</li> <li>at 400 V rated value</li> <li>at 500 V rated value</li> <li>at 690 V rated value</li> </ul>  | 100 kA<br>100 kA<br>100 kA<br>100 kA   |
| response value current of instantaneous short-circuit trip unit   | 8.2 A  |
| <b>UL/CSA ratings</b>   |  |
| <b>full-load current (FLA) for 3-phase AC motor</b>   |  |
| <ul style="list-style-type: none"> <li>at 480 V rated value</li> <li>at 600 V rated value</li> </ul>  | 0.4 A<br>0.4 A   |
| <b>Short-circuit protection</b>   |  |
| <b>product function short circuit protection</b>  | Yes  |
| <b>design of the short-circuit trip</b>   | magnetic   |
| <b>Installation/ mounting/ dimensions</b>   |  |
| <b>mounting position</b>  | any  |
| <b>fastening method</b>   | screw and snap-on mounting onto 35 mm standard mounting rail according to DIN EN 60715 |
| <b>height</b>   | 97 mm  |
| <b>width</b>  | 45 mm  |
| <b>depth</b>  | 97 mm  |
| <b>required spacing</b>   |  |
| <ul style="list-style-type: none"> <li>for grounded parts at 400 V <ul style="list-style-type: none"> <li>downwards</li> <li>upwards</li> <li>at the side</li> </ul> </li> <li>for live parts at 400 V <ul style="list-style-type: none"> <li>downwards</li> <li>upwards</li> </ul> </li> </ul>   | 30 mm<br>30 mm<br>9 mm<br><br>30 mm<br>30 mm   |

|                               |       |
|-------------------------------|-------|
| — at the side                 | 9 mm  |
| • for grounded parts at 500 V |       |
| — downwards                   | 30 mm |
| — upwards                     | 30 mm |
| — at the side                 | 9 mm  |
| • for live parts at 500 V     |       |
| — downwards                   | 30 mm |
| — upwards                     | 30 mm |
| — at the side                 | 9 mm  |
| • for grounded parts at 690 V |       |
| — downwards                   | 50 mm |
| — upwards                     | 50 mm |
| — backwards                   | 0 mm  |
| — at the side                 | 30 mm |
| — forwards                    | 0 mm  |
| • for live parts at 690 V     |       |
| — downwards                   | 50 mm |
| — upwards                     | 50 mm |
| — backwards                   | 0 mm  |
| — at the side                 | 30 mm |
| — forwards                    | 0 mm  |

#### Connections/ Terminals

|  |   |
|--|---|
| <b>type of electrical connection</b>                                 |   |
| • for main current circuit   | screw-type terminals  |
| <b>arrangement of electrical connectors for main current circuit</b> | Top and bottom  |
| <b>type of connectable conductor cross-sections</b>                  |   |
| • for main contacts  |   |
| — solid or stranded  | 2x (0,75 ... 2,5 mm <sup>2</sup> ), 2x 4 mm <sup>2</sup>              |
| — finely stranded with core end processing                           | 2x (0.5 ... 1.5 mm <sup>2</sup> ), 2x (0.75 ... 2.5 mm <sup>2</sup> ) |
| • at AWG cables for main contacts                                    | 2x (18 ... 14), 2x 12   |
| <b>tightening torque</b>   |   |
| • for main contacts with screw-type terminals                        | 0.8 ... 1.2 N·m   |
| <b>design of screwdriver shaft</b>                                   | Diameter 5 to 6 mm  |
| <b>size of the screwdriver tip</b>                                   | Pozidriv size 2   |
| <b>design of the thread of the connection screw</b>                  |   |
| • for main contacts  | M3  |

#### Safety related data

|   |  |
|---|--|
| <b>B10 value</b>  |  |
| • with high demand rate according to SN 31920                           | 5 000  |
| <b>proportion of dangerous failures</b>                                 |  |
| • with low demand rate according to SN 31920                            | 50 %   |
| • with high demand rate according to SN 31920                           | 50 %   |
| <b>failure rate [FIT]</b>   |  |
| • with low demand rate according to SN 31920                            | 50 FIT   |
| T1 value for proof test interval or service life according to IEC 61508 | 10 y   |
| <b>protection class IP on the front according to IEC 60529</b>          | IP20   |
| <b>touch protection on the front according to IEC 60529</b>             | finger-safe, for vertical contact from the front |
| display version for switching status                                    | Handle   |

#### Certificates/ approvals

General Product Approval













[Confirmation](#)



[KC](#)



| Declaration of Conformity  |   | Test Certificates  |   | Marine / Shipping   |  |
|--|---|--|---|---|--|
|         | <br>EG-Konf. | <a href="#">Type Test Certificates/Test Report</a>                                       | <a href="#">Special Test Certificate</a>  | <br>ABS  | <br>BUREAU<br>VERITAS |
| Marine / Shipping  |   |  |   |   | other  |
| <br>DNV | <br>LRS      | <br>PRS | <br>RINA | <br>RMRS | <a href="#">Confirmation</a>   |
| other  | Railway   |  |   |   |  |
| <br>VDE | <a href="#">Vibration and Shock</a>   | <a href="#">Confirmation</a>   |   |   |  |

#### Further information

Information- and Downloadcenter (Catalogs, Brochures,...)

<https://www.siemens.com/ic10>

Industry Mall (Online ordering system)

<https://mall.industry.siemens.com/mall/en/en/Catalog/product?mlfb=3RV2411-0EA10>

Cax online generator

<http://support.automation.siemens.com/WW/CAXorder/default.aspx?lang=en&mlfb=3RV2411-0EA10>

Service&Support (Manuals, Certificates, Characteristics, FAQs,...)

<https://support.industry.siemens.com/cs/ww/en/ps/3RV2411-0EA10>

Image database (product images, 2D dimension drawings, 3D models, device circuit diagrams, EPLAN macros, ...)

[http://www.automation.siemens.com/bilddb/cax\\_de.aspx?mlfb=3RV2411-0EA10&lang=en](http://www.automation.siemens.com/bilddb/cax_de.aspx?mlfb=3RV2411-0EA10&lang=en)

Characteristic: Tripping characteristics, I<sup>2</sup>t, Let-through current

<https://support.industry.siemens.com/cs/ww/en/ps/3RV2411-0EA10/char>

Further characteristics (e.g. electrical endurance, switching frequency)

<http://www.automation.siemens.com/bilddb/index.aspx?view=Search&mlfb=3RV2411-0EA10&objecttype=14&gridview=view1>

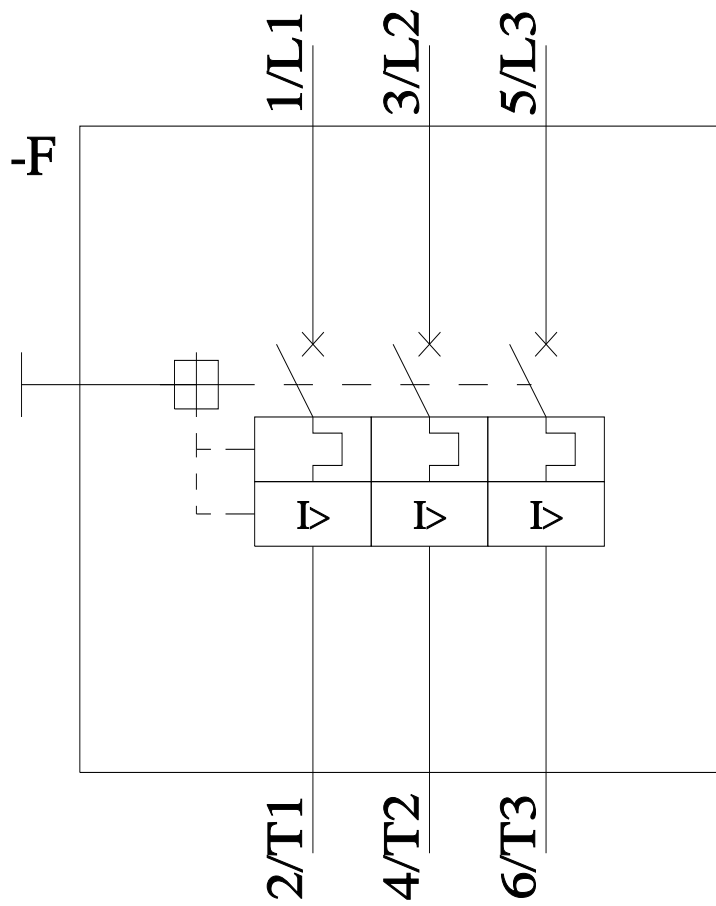

last modified:

6/25/2022 