

# Analog Devices Welcomes Hittite Microwave Corporation

NO CONTENT ON THE ATTACHED DOCUMENT HAS CHANGED

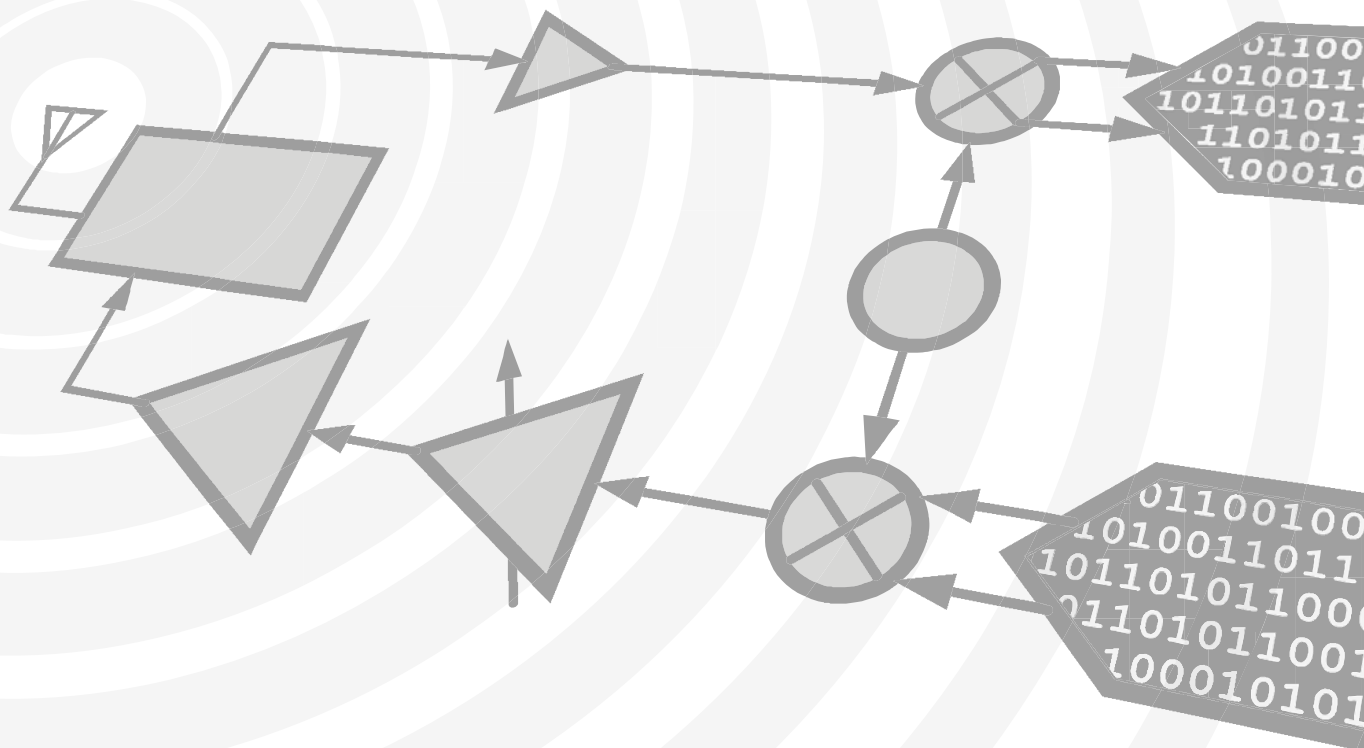

**THIS PAGE INTENTIONALLY LEFT BLANK**

### Typical Applications

The HMC998LP5E is ideal for:

- Test Instrumentation
- Microwave Radio & VSAT
- Military & Space
- Telecom Infrastructure
- Fiber Optics

### Features

- P1dB Output Power: +31 dBm
- Psat Output Power: +33 dBm
- High Gain: 11 dB
- Output IP3: +41 dBm
- Supply Voltage: Vdd = +15V @ 500 mA
- 50 Ohm Matched Input/Output
- 32 Lead 5x5 mm SMT Package: 25 mm<sup>2</sup>

### Functional Diagram

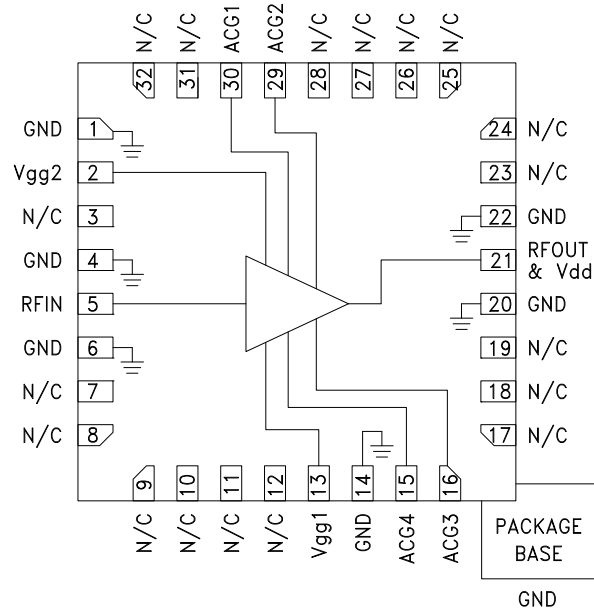

### General Description

The HMC998LP5E is a GaAs pHEMT MMIC Distributed Power Amplifier which operates between 0.1 and 20 GHz. The amplifier provides 11 dB of gain, +41 dBm output IP3, and +31 dBm of output power at 1 dB gain compression while requiring only 500 mA from a +15V supply. The HMC998LP5E exhibits a slightly positive gain from 3 to 17 GHz making it ideal for EW, ECM, Radar and test equipment applications. The HMC998LP5E amplifier I/Os are internally matched to 50 Ohms and is supplied in a leadless QFN 5x5 mm surface mount package.

### Electrical Specifications, $T_A = +25^\circ C$ , $V_{dd} = +15V$ , $V_{gg2} = +9.5V$ , $I_{dd} = 500 mA$ [1]

| Parameter                                | Min. | Typ.    | Max. | Min.   | Typ.  | Max. | Min.    | Typ.  | max | Units |
|--|------|---------|------|--------|-------|------|---------|-------|-----|-------|
| Frequency Range                          |      | 0.1 - 4 |      | 4 - 16 |       |      | 16 - 20 |       |     | GHz   |
| Gain                                     | 8    | 11      |      | 8      | 11    |      | 9       | 12    |     | dB    |
| Gain Flatness                            |      | ±0.3    |      |        | ±0.5  |      |         | ±0.5  |     | dB    |
| Gain Variation Over Temperature          |      | 0.006   |      |        | 0.012 |      |         | 0.017 |     | dB/°C |
| Input Return Loss                        |      | 17      |      |        | 15    |      |         | 25    |     | dB    |
| Output Return Loss                       |      | 10      |      |        | 15    |      |         | 20    |     | dB    |
| Output Power for 1 dB Compression (P1dB) | 28   | 31      |      | 28     | 31    |      | 26      | 29    |     | dBm   |
| Saturated Output Power (Psat)            |      | 33      |      |        | 33    |      |         | 31    |     | dBm   |
| Output Third Order Intercept (IP3) [2]   |      | 41      |      |        | 41    |      |         | 40    |     | dBm   |
| Noise Figure                             |      | 8       |      |        | 4.5   |      |         | 5     |     | dB    |
| Total Supply Current                     |      | 500     |      |        | 500   |      |         | 500   |     | mA    |

[1] Adjust Vgg between -2 to 0V to achieve Idd = 500 mA typical.

[2] Measurement taken at Pout / tone = +14 dBm.



**GaAs pHEMT MMIC  
2 WATT POWER AMPLIFIER, 0.1 - 20 GHz**

**Gain & Return Loss**

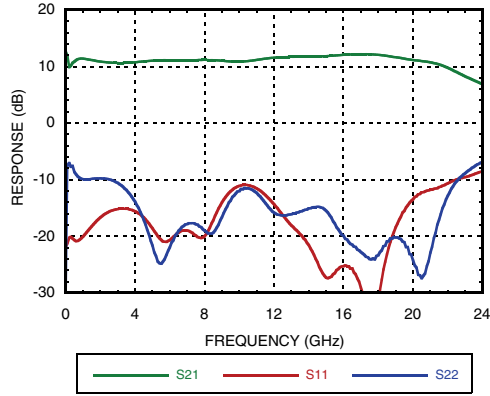

**Gain vs. Temperature**

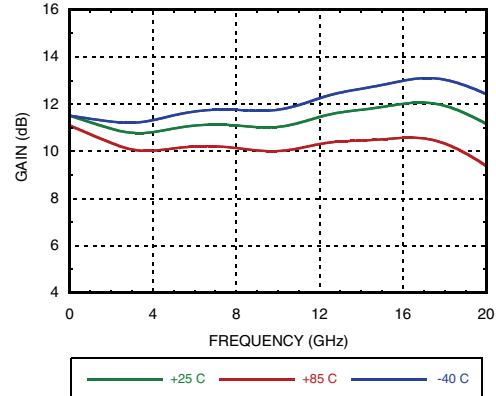

**Input Return Loss vs. Temperature**

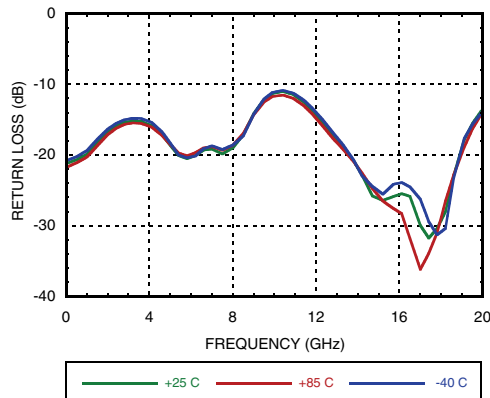

**Output Return Loss vs. Temperature**

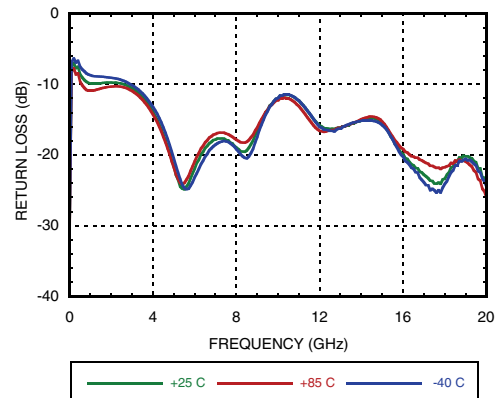

**Low Frequency Gain & Return Loss**

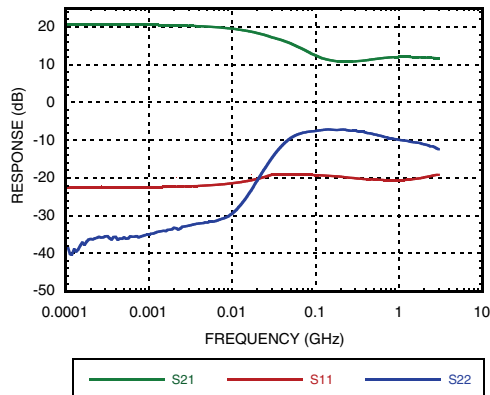

**Noise Figure vs. Temperature**

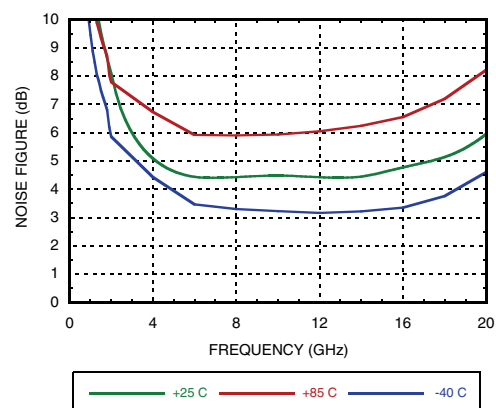

**P1dB vs. Temperature**

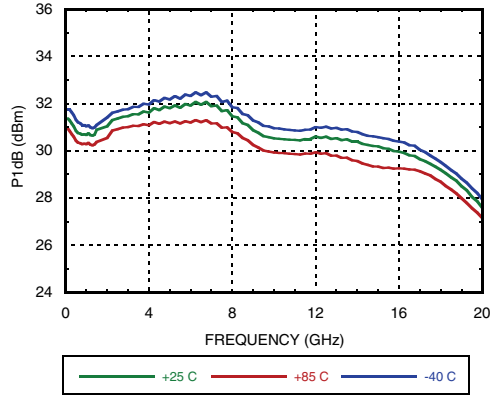

**Psat vs. Temperature**

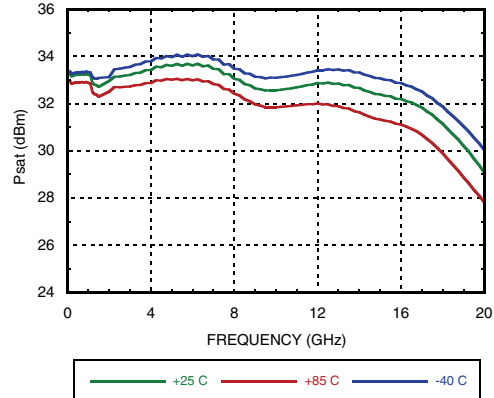

**P1dB vs. Supply Voltage**

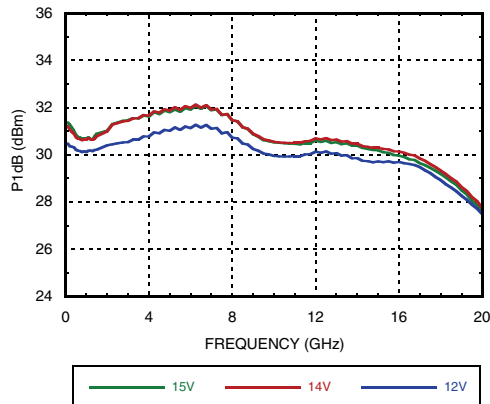

**Psat vs. Supply Voltage**

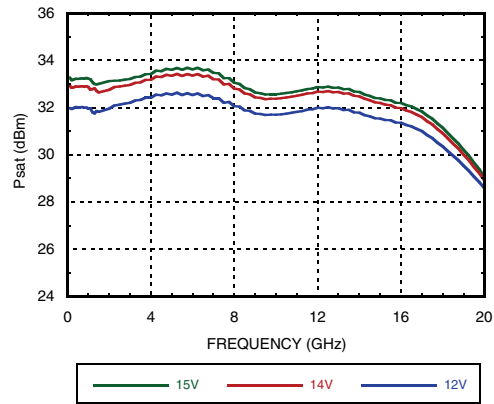

**Output IP3 vs. Temperature,  
Pout/tone = +18 dBm**

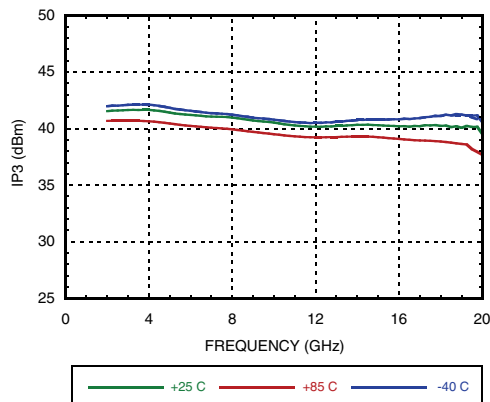

**Output IP3 vs. Supply Voltage,  
Pout/tone = +18 dBm**

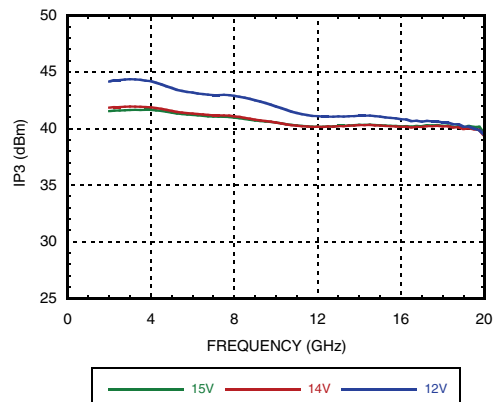



**GaAs pHEMT MMIC  
2 WATT POWER AMPLIFIER, 0.1 - 20 GHz**

**Output IP3 vs. Idd @ 10 GHz**

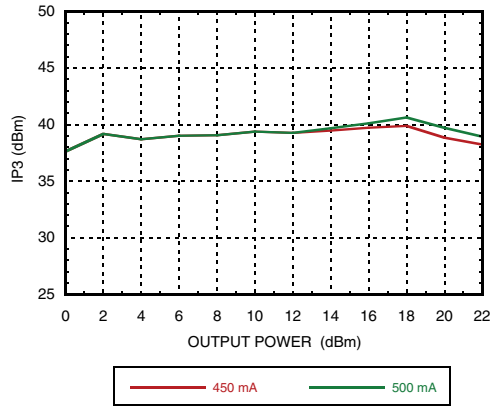

**Power Compression @ 4 GHz**

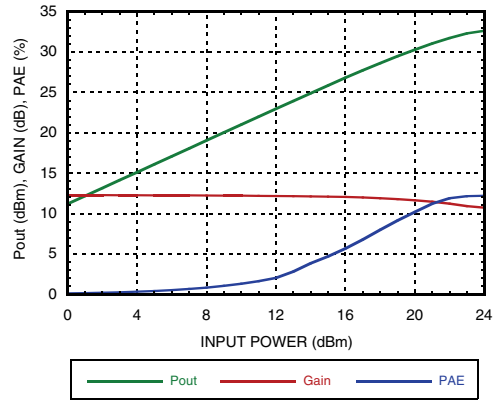

**Power Compression @ 10 GHz**

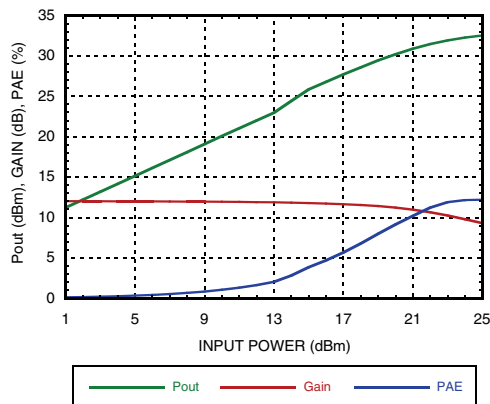

**Power Compression @ 18 GHz**

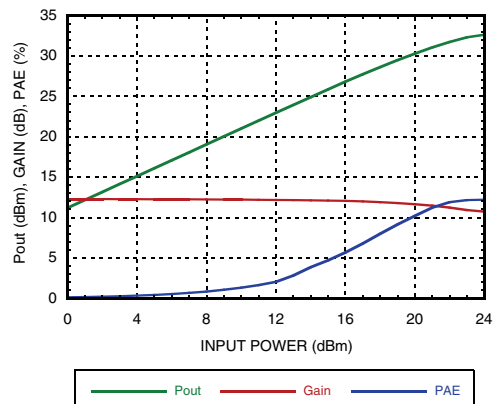

**Power Dissipation**

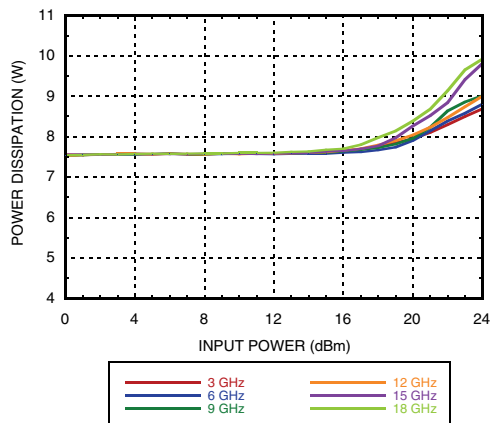

**Second Harmonics vs. Temperature @ Pout = 18 dBm**

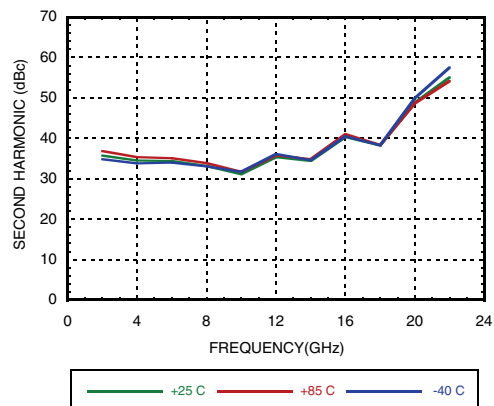

**Second Harmonics vs. Vdd  
@ Pout = 18 dBm**

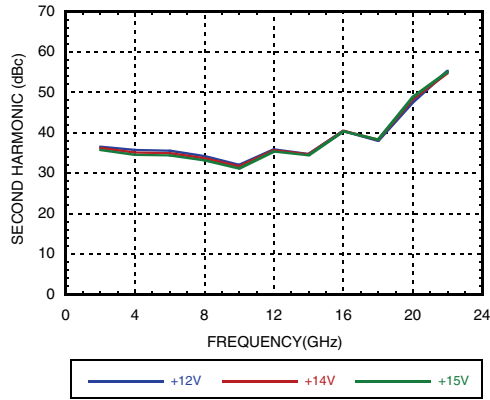

**Second Harmonics vs Pout**

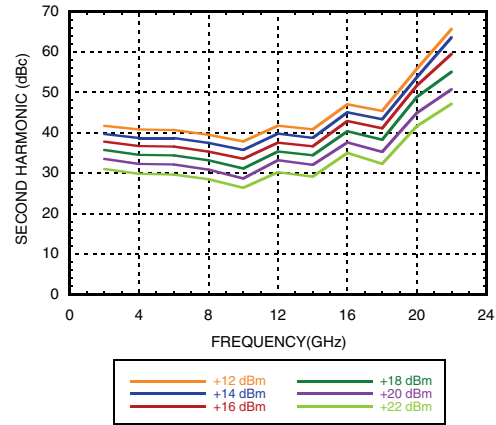

**Reverse Isolation vs. Temperature**

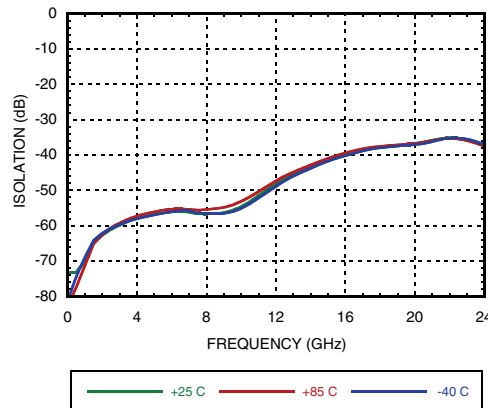

### Absolute Maximum Ratings

|   |                                 |
|---|---------------------------------|
| Drain Bias Voltage (Vdd)                                      | +17 Vdc                         |
| Gate Bias Voltage (Vgg1)                                      | -3 to 0 Vdc                     |
| Gate Bias Voltage (Vgg2)                                      | Vgg2 = (Vdd-6.5V) to (Vdd-4.5V) |
| RF Input Power (RFIN)   | +27 dBm                         |
| Channel Temperature   | 150 °C                          |
| Continuous Pdiss (T= 85 °C)<br>(derate 127 mW/°C above 85 °C) | 8.26 W                          |
| Thermal Resistance<br>(channel to gnd paddle)                 | 7.87 °C/W                       |
| Output Power into VSWR > 7:1                                  | +32 dBm                         |
| Storage Temperature   | -65 to 150°C                    |
| Operating Temperature   | -40 to 85 °C                    |
| ESD Sensitivity (HBM)   | Class 1A                        |

### Typical Supply Current vs. Vdd

| Vdd (V) | Idd (mA) |
|---------|----------|
| +15     | 500      |
| +14     | 500      |
| +13     | 500      |
| +12     | 500      |

Adjust Vgg1 to achieve Idd = 500 mA



**ELECTROSTATIC SENSITIVE DEVICE  
OBSERVE HANDLING PRECAUTIONS**

### Outline Drawing

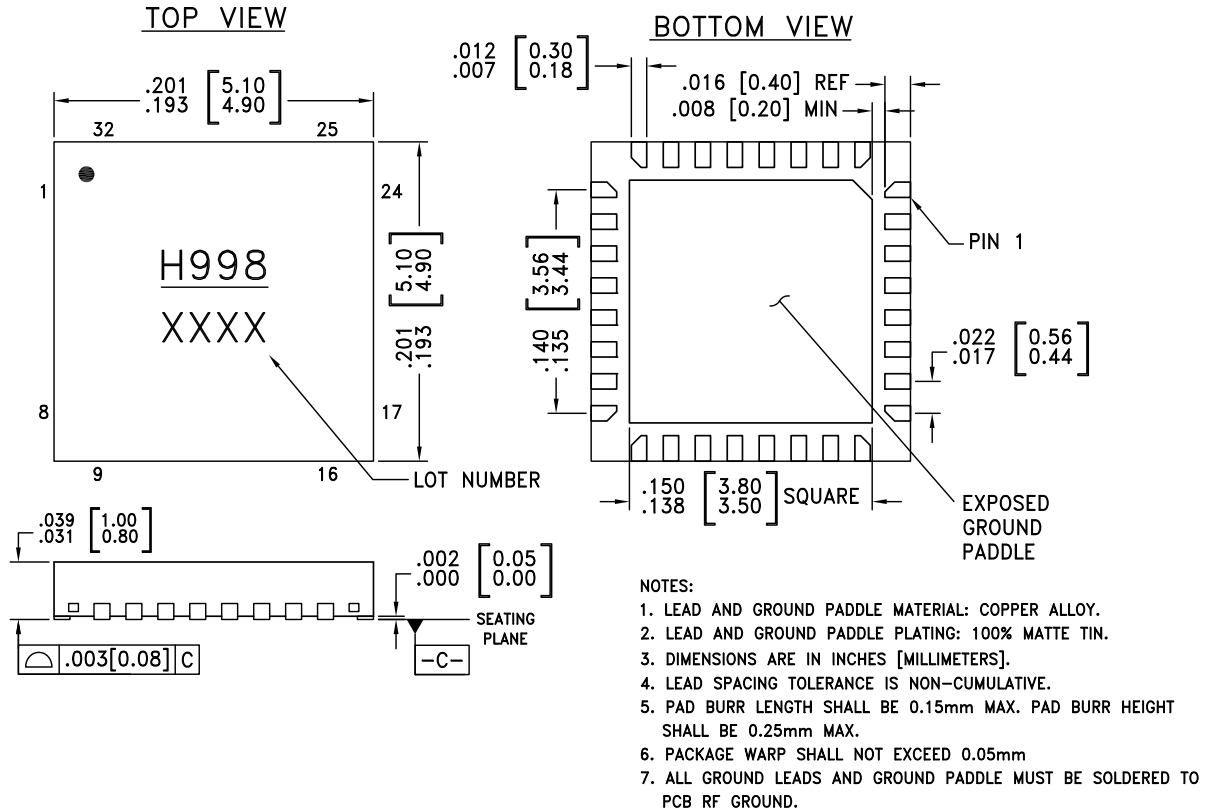

### Package Information

| Part Number | Package Body Material                              | Lead Finish   | MSL Rating <sup>[2]</sup> | Package Marking <sup>[1]</sup> |
|-------------|--|---------------|---------------------------|--------------------------------|
| HMC998LP5E  | RoHS-compliant Low Stress Injection Molded Plastic | 100% matte Sn | MSL3                      | H998<br>XXXX                   |

[1] 4-Digit lot number XXXX

[2] Max peak reflow temperature of 260 °C

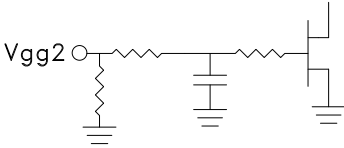
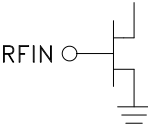
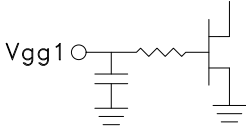
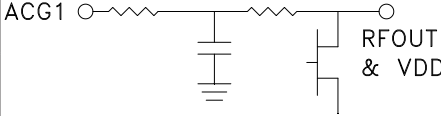

### Pin Descriptions

| Pin Number   | Function    | Description  | Interface Schematic   |
|--|-------------|--|---|
| 1, 4, 6, 14, 20, 22,   | GND         | These pins and package bottom must be connected to RF/DC ground.   |    |
| 2  | Vgg2        | Gate control for amplifier. Attach bypass capacitor per application circuit herein. For nominal operation +9.5V should be applied to Vgg2.     |    |
| 3, 7, 8, 9, 10, 11, 12, 17, 18, 19, 23, 24, 25, 26, 27, 28, 31, 32 | N/C         | These pins are not connected internally, however all data shown herein was measured with these pins connected to RF/DC ground externally.      |   |
| 5  | RFIN        | This pad is DC coupled and matched to 50 Ohms. Blocking capacitor is required.   |   |
| 13   | Vgg1        | Gate control 1 for amplifier. Attach bypass capacitor per application circuit herein. Please follow "MMIC Biasing Procedure" application note. |  |
| 15, 29   | ACG4, ACG2  | Low frequency termination. Attach bypass capacitor per application circuit.  |   |
| 21   | RFOUT & VDD | RF output for amplifier. Connect DC bias (Vdd) network to provide drain current (Idd). See application circuit herein.                         |   |
| 30   | ACG1        | Low frequency termination. Attach bypass capacitor per application circuit herein.   |   |

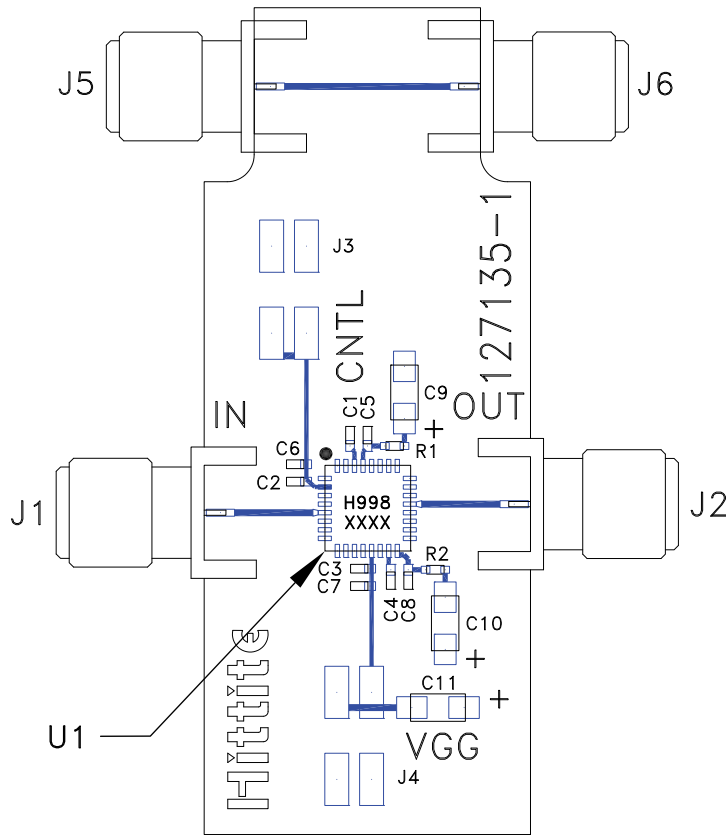
**Evaluation Order Information**

| Item                | Contents                  | Part Number                      |
|---------------------|---------------------------|----------------------------------|
| Evaluation PCB Only | HMC998LP5E Evaluation PCB | Eval01-HMC998LP5E <sup>[1]</sup> |

[1] Reference this number when ordering Evaluation PCB Only

**List of Materials for Evaluation PCB EVAL01-HMC998LP5E**

| Item               | Description                       |
|--------------------|-----------------------------------|
| J1, J2, J5, J6     | PCB Mount SMA RF Connector        |
| J3, J4             | DC Pins.                          |
| C1 - C4            | 1000 pF Capacitor, 0402 Pkg.      |
| C5 - C8            | 10 k $\mu$ F Capacitor, 0402 Pkg. |
| C9 - C11           | 4.7 $\mu$ F Capacitor, Tantalum.  |
| R1, R2             | 0 Ohm Resistor, 0402 Pkg.         |
| U1                 | HMC998LP5E                        |
| PCB <sup>[1]</sup> | 127135 Evaluation PCB.            |

[1] Circuit Board Material: Rogers 4350 or Arlon 25FR

The circuit board used in the application should use RF circuit design techniques. Signal lines should have 50 Ohm impedance while the package ground leads and exposed paddle should be connected directly to the ground plane similar to that shown. A sufficient number of via holes should be used to connect the top and bottom ground planes. The evaluation circuit board shown is available from Hittite upon request.

### Application Circuit

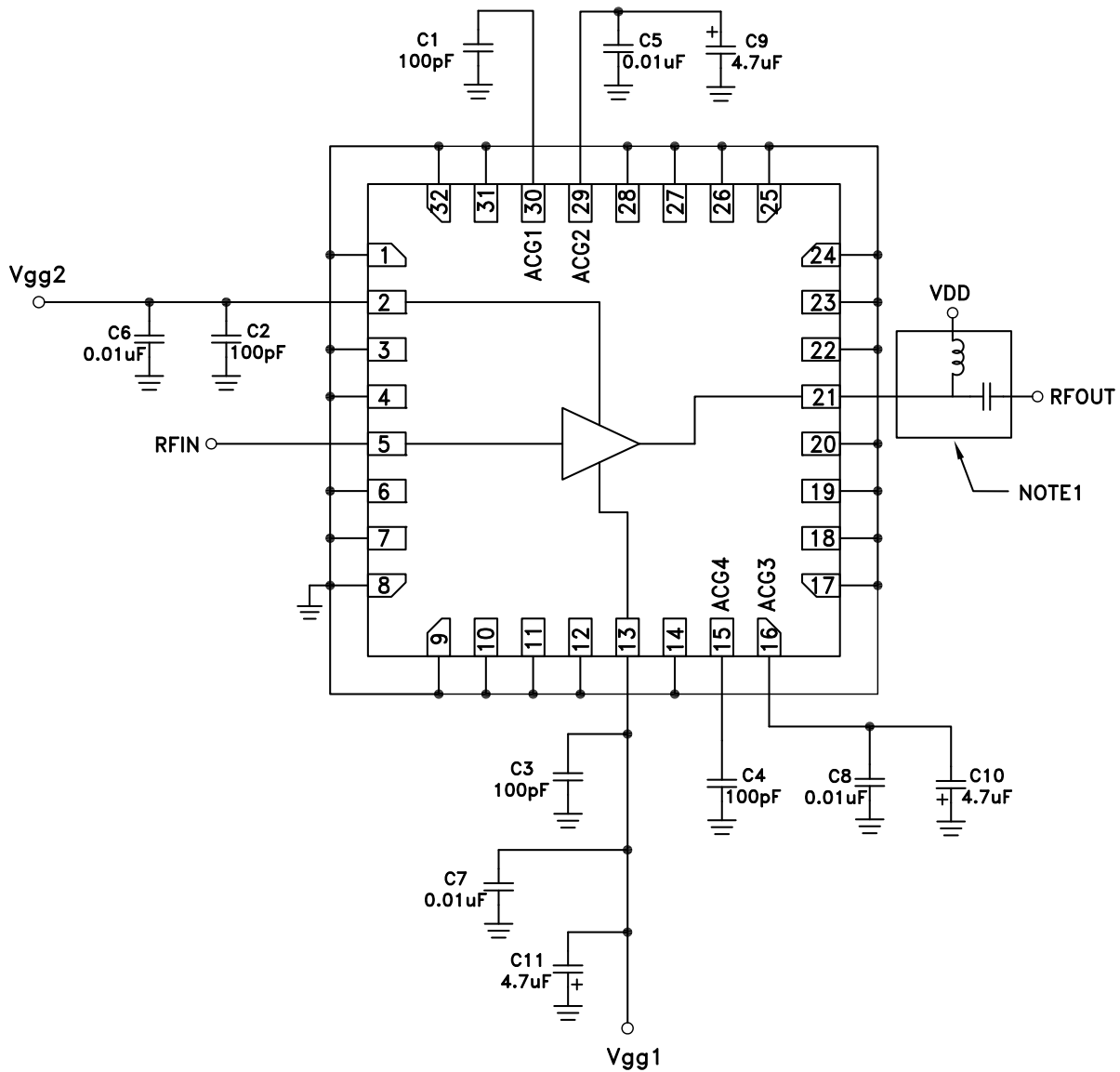

NOTE 1: Drain Bias (Vdd) must be applied through a broadband bias tee or external bias network.



**Notes:**